

Practical Computing

50p

February 1980

Volume 3 Issue 2

**Home
computer
networks**

**Reviews:
MiniMax
Video Genie**

**Make your PET
printer sing
and dance**

**NEW: Professional
software guide**

**Robotics –
What's happening**



The computer with growth potential

The System Three is Cromemco's best selling small business computer. It's easy to see why.

Not only is it ideal for the first time computer user. But perhaps more important, it can be expanded into a comprehensive business facility servicing many varied company requirements.

Single-user system

You can start small. A 64K computer with a megabyte of floppy disc storage costs under £4,000.*

Perhaps your initial reason for choosing Cromemco was its flexible database management system—ideal for client records, order processing, sales analysis, inventory control, and many more business uses; or you might have required the full screen word processing system, capable of printing up to 20 original letters an hour; possibly you needed Cobol, Basic or Fortran, to develop your own customised packages.

Easy to use

Whatever the reason, you were highly impressed with the ease with which your very first computer application got off the ground. So you added another. And another. And pretty soon quite a lot of company business was running on your Cromemco.



Single-user System Three, with 64K memory, 2 discs, terminal and printer. Ideal for small businesses.

Will it expand?

It was then you discovered that the terminal is the limiting factor, because of the time taken to input data. If only you could connect a second terminal you could double your system's workload. . .

Multi-user system

Fortunately, we can readily expand your Cromemco. Unlike other makers' systems, all we need to do is add some memory and a ® TU-ART interface, and the multi-user system is ready to run . . . with a printer and up to 7 terminals, each with up to 48K.

New operating system

Moreover, your terminals can function quite independently of each other. Under Cromemco's new operating system they can be used to update and interrogate the company's database; for correspondence, with the word processing system; for data entry, using the full screen editor; or indeed for running any combination of CP/M software, *simultaneously*.

Up to 72 megabytes

We can increase your floppy disc storage to 2 megabytes if necessary. And if that's not enough, we can also add Cromemco's hard discs to provide you with up to an amazing **72 megabytes** on-line.

Rely on MicroCentre

Remember—at MicroCentre we fully understand Cromemco systems. That's why we're Cromemco's top UK distributors. So trust your initial Cromemco investment to MicroCentre. And call us any time to discuss your hardware enhancements or software needs.

Your company's future growth may depend on it.



Multi-user System Three, with 320K memory, 4 discs, 7 terminals and fast line printer. Each terminal has its own operating system, and can run any software package independently.

*Price excludes VAT and delivery. Terminals and printers to be added according to user requirements. ® TU-ART is a Cromemco trademark.

For  **Cromemco... call the experts**

Tel. 031-225 2022

Micro Centre

Complete Micro Systems Ltd., 132 St. Stephen Street, Edinburgh EH3 5AA

Editor
Peter Laurie
Technical Editor
Nick Hampshire
Staff Writer
Duncan Scot
Production
Martin Hayman
Art
Margaret Smith
Editorial Secretary
Susie Manning
Advertisement Department
Tom Moloney
Tina Roberts
David Lake
Publishing Director
Christopher Hipwell
Editorial: 01-261 8752
Advertising: 01-261 8000

Practical Computing is published by IPC Electrical Electronic Press Ltd, Dorset House, Stamford Street, London SE1 9LU. Tel: 01-261 8000
Telegrams/Telex: 25137 BISPRSG

and printed by Eden Fisher Ltd, Southend-on-Sea.

Distributed by IPC Sales and Distribution Ltd, 40 Bowling Green Lane, London, EC1R 0NE. Typesetting & Artwork by Bow-Towning Ltd, London EC1.

Subscription Rates:
Single copy: 50p.
Subscriptions: U.K., £6 per annum (including airmail postage).
Europe (excluding U.K.), £12;
Elsewhere in the world: £18.

Subscription Enquiries:
Subscription Manager
IPC Business Press (S. and D.) Ltd.
Oakfield House,
Perrymount Road,
Haywards Heath,
Sussex RH16 3DH.
Tel: 0444 59188.

©IPC Business Press Ltd 1979
ISSN 0141-5433.

Every effort has been made to ensure accuracy of articles and program listing. Practical Computing cannot, however, accept any responsibility whatsoever for any errors.

CONTENTS

- 51** Editorial / Please Mr Editor, what computer should I buy?
- 53** Printout / Talkback Tina won't keep you waiting; High Street retailer jumps on the bandwagon
- 56** Feedback / The language debate; the Dream Machine; Poetry Corner
- 61** Minimax makes the most of user program space / Jim Wood reviews a promising new machine
- 64** The ten commands: will they change your life? / John James take a sceptical look at an add-on machine code chip for the PET
- 68** Genie's missing magic / Your wish is my command — up to a point
- 72** Personal computer networks / Better than the next best thing to being there
- 78** The Randomiser by John Abbatt / Fear and loathing again in Las Vegas
- 82** Removing the buttons / Tomorrow's micro consumer doesn't want to know he's using a computer, so keep it simple, urges Nick Laurie
- 87** In Space, no-one can hear you think / Blake7: a simulated battle game by D. N. Sands
- 92** Nuts and bolts fix for the learning process / J. A. M. Howe on model building for education
- 98** What rough beast, its hour come round at last . . . / Mark Witkowski sketches the background to the Micromouse contest in the first of a series on robotics
- 105** Head up your own letters / Rex Tingey on Commodore's Printer
- 112** Gallery moves out of the flat earth era / Even in the antiques business, the micro has its uses
- 114** Smaller, faster, quicker, slicker . . . and more elegant too / C. A. Malcolm says keep it brief, like the pros
- 119** Micromouse & Pet & Tandy / Handy tips
- 127** High-speed stepper motors and the PET/
- 161** Diary / Where to learn, what it costs
- 163** Glossary / Continuing the technological gamut with P

Our cover by Frank Phipps shows a world of the future, when networked micros make it possible to work at home. The city is wasting away; oil shortage has abolished cars in favour of the horse.

New! Produced and widely used in England and USA

Complete Business Package

**INCLUDES EVERYTHING FROM INVENTORY TO SALES SUMMARY
PROMPTS USER. VALIDATES EACH ENTRY, MENU DRIVEN**

Approximately 60-100 entries/inputs require only 2-4 hours weekly and your entire business is under control.

***PROGRAMS ARE INTEGRATED—**

- 01 = ENTER NAMES/ADDRESS, ETC
- 02 = *ENTER/PRINT INVOICES
- 03 = *ENTER PURCHASES
- 04 = *ENTER A/C RECEIVABLES
- 05 = *ENTER A/C PAYABLES
- 06 = ENTER/UPDATE INVENTORY
- 07 = ENTER/UPDATE ORDERS
- 08 = ENTER/UPDATE BANKS
- 09 = EXAMINE/MONITOR SALES LEDGER
- 10 = EXAMINE/MONITOR PURCHASE LEDGER
- 11 = EXAMINE/PRINT INCOMPLETE RECORDS
- 12 = EXAMINE PRODUCT SALES

SELECT FUNCTION BY NUMBER—

- 13 = PRINT CUSTOMER STATEMENT
- 14 = PRINT SUPPLIER STATEMENTS
- 15 = PRINT AGENT STATEMENTS
- 16 = PRINT TAX STATEMENTS
- 17 = PRINT WEEK/MONTH SALES
- 18 = PRINT WEEK/MONTH PURCHASES
- 19 = PRINT YEAR AUDIT
- 20 = PRINT PROFIT/LOSS ACCOUNT
- 21 = UPDATE END MONTH FILES & MAINTENANCE
- 22 = PRINT CASH FLOW FORECAST
- 23 = ENTER/UPDATE PAYROLL (NOT YET AVAILABLE)
- 24 = RETURN TO BASIC

WHICH ONE? (ENTER 1-24). SUB MENU EXAMPLE: 01 = EXAMINING; 02 = INSERT; 03 = AMEND; 04 = DELETE
05 = PRINT (1,2,3); 06 = NUMERIC COMBINATIONS; 07 = SORT.
*VERY FLEXIBLE. ADD YOUR OWN FUNCTIONS. EASY TO INTEGRATE.
All programs in BASIC for CP/M • PET • 6800.

**PRICES: Programs 1-23 excluding (19,20,22,23) £475 inclusive £575.
Stock Integrated option + £100.**

**IMPORTANT! We also sell the hardware to do the above tasks
so you can purchase the complete system from one source.**

PET COMPUTER 32K	£795
PET FLOPPY DISK	£795
PET PRINTER T/FEED	£645
PET CABLES	£45
PAPER	£28.50
10 DISKETTES	£28.50
1 YEAR'S SOFTWARE SUPPORT	£50.00
	£2387.00

SUPERBRAIN Z80	
TWIN FLOPPY D/DENSITY 5 1/4"	
32K RAM	£1950
64K RAM	£2095

PRINTER OPTIONS:

a) Paper tiger 195 cps	£585
b) Texas 810 150 cps	£1495
c) Teletype 43 30 cps	£895
d) DEL LA34 30 cps	£895
e) QUME Daisy Wheel 45 cps	£2450
f) NEC spin writer 55 cps	£1950

Specials:

48K Industrial Microsystems Z80 & Twin D/Drives 5 1/4"	£2000
Intertube Video terminals	£495
40K SWTP 6800 + Twin D/Density 5 1/4" Drives	£1000

Walkie talkie telephone (Freedom phone) connects to normal telephone make or take calls 300ft from £195 (Not P.O. approved).

CALL FOR SPECIAL ALL IN DEALS
Warrenty included free. Replacement of equipment within 90 days if found defective.

Telephone answering machine recall messages anywhere in the world £195 (Not P.O. approved).

**WE EXPORT TO ALL COUNTRIES: CALLERS BY APPOINTMENT ONLY.
CONTACT TONY WINTER 01-636 8210**

**G. W. Computers Ltd.
89 Bedford Ct Mansions
Bedford Avenue
London WC1 UK**

The  **Cromemco**

Z-2H



11 Megabytes of hard disc storage in a fast, new, table-top computer.

- Fast Z80A 4MHz processor
- 11-megabyte hard disc drive
- Two floppy disc drives
- 64K RAM memory
- RS-232 serial interface
- Printer interface
- Extensive software available

CAMBRIDGE
CAMBERLEY
ILFORD

LEEDS

LONDON
LUTON
MANCHESTER

NEWBURY

NEWPORT
NOTTINGHAM

SHEFFIELD
SOUTHAMPTON

CAMBRIDGE COMPUTER STORE, Cambridge (0223) 68155
MICROBITS, Camberley, Surrey (0276) 34044

THE BYTE SHOP, Wford, Essex 01 554 2177

also at Tottenham Court Road, London 01-636 0647

HOLDENE LIMITED, Leeds (0532) 459459

also at Wilmslow, Cheshire (0625) 529486

DIGITUS LIMITED, London W1 01 636 0105

ISHERWOODS, Luton, Bedfordshire (0582) 424851

MICROCOMPUTERMART, Manchester (061-832) 2269

also at West Park, Leeds (0532) 789466

NEWBEAR COMPUTING STORE, Newbury Berks (0635) 30505

also at Stockport, Cheshire (061 491) 2290

MICROMEDIA SYSTEMS, Newport Gwent (0633) 50528

COMPUTERLAND LIMITED, Nottingham (0602) 40576

also at Birmingham (021 622) 7149

Manchester 061-236 4737

Glasgow (041 332) 2468

HALLAM COMPUTER SYSTEMS, Sheffield (0742) 663125

XITAN SYSTEMS LIMITED, Southampton (0703) 38740



comart specialists in microcomputers

Comart Ltd., P.O. Box 2, St. Neots, Huntingdon, Cambs, PE19 4NY. Tel: (0480) 215005 Telex: 32514

• Circle No. 103

Scotland 18, 19, 20 March – Albany Hotel, Douglas Street, Glasgow
 North West 11, 12, 13 March – New Century Hall, Corporation Street, Manchester
 Midlands 4, 5, 6 March – Albany Hotel, Smallbrook Queensway, Birmingham
 London 25, 26, 27 March – West Centre Hotel, Lillie Road, London SW6

COMPUTERMA

Your first computer?

If you're thinking about your first computer for home or office, a visit to Computermarket will save you time and money. You'll be able to compare prices in just one visit, see who is committed to your area, meet people who have installed the sort of equipment you are considering, check out after sales service arrangements with more than just one potential supplier and see computers performing the applications of interest to you. You'll see micro-computers from just a few hundreds of pounds and highly sophisticated systems costing hundreds of thousands. You'll be able to examine the enhancements you may later wish to add to your computer and check out that the system can be upgraded, investigate the availability and cost of the supplies that you'll need to get and keep your computer running. You might even actually see a silicon chip!

OEM/System builder?

Hasn't your marketplace changed since you first thought about the business you're in? 16 bit micros, midi-computers, bread-boards for peanuts, matrix line printers, smart VDUs for the price of dumb ones, famous names that you hadn't heard of only months ago. Customized or off-the-shelf, it must sometimes look like the world and his wife is starting a systems house. Who is in your business in your area? A visit to Computermarket will tell you and a lot more besides including who can supply at least cost and fastest delivery.

Computer user?

If you've already got a computer, you'll know who gives the best service on supplies in your area – won't you? You'll already know where you can get short delivery and best terms on the peripheral enhancements you plan – won't you? You'll be aware of the software packages that are available for your existing equipment – won't you? You've probably thought about the additional processor (or its replacement) you will need before too long – haven't you? Why not check and be sure. A visit to Computermarket will confirm that you are right and will continue to get the best deal on peripherals, ancillary equipment, services, software, supplies . . . and it will give you the opportunity to see micro and mini based systems in operation just to keep up-to-date and for interest's sake – won't it?

Communications user?

Are you getting the most from your system? An acoustic coupler can cost very little and yet be the start of a communications network. Modems, multi-plexers . . . the hardware of data communications is developing fast and so is the environment in which the equipment may be employed. Communications experts will be at Computermarket so if it's a terminal in another part of your building, distributing data processing or starting your own satellite communications network (!), a visit to Computermarket should prove to be a worthwhile investment and a chance to study PRESTEL at first hand.

Who will be at Computermarket?

Advertisements such as these are prepared many months in advance of the exhibitions described, but it is already certain that Computermarket will be bigger than ever before – more than twice as big overall. Companies that had already reserved stands as at November (almost four months before the 1980 series of exhibitions) included:-

- ▣ Zygol, Wootton Jeffreys, Willis Computer Supplies, Which Computer?, Wespac, Wang, Versatec, Tullis Neill, Terminal Display Systems, Telema, Tektronix, Tann Synchro-nome, Systime, Sumlock Bondain, Star Computer Centre, Scotia Data Products, SEMS, Selborne Computers, SEL, Rostronics, Robox, Rair, Q-Pac Services, Pragma, Post Office, Plessey Peripherals, Peterborough Data, Richard Norton, Northern Software Consultants, Newbury Laboratories, Nashua, Nascom, NSC Computers, Modular Technology, Modem,

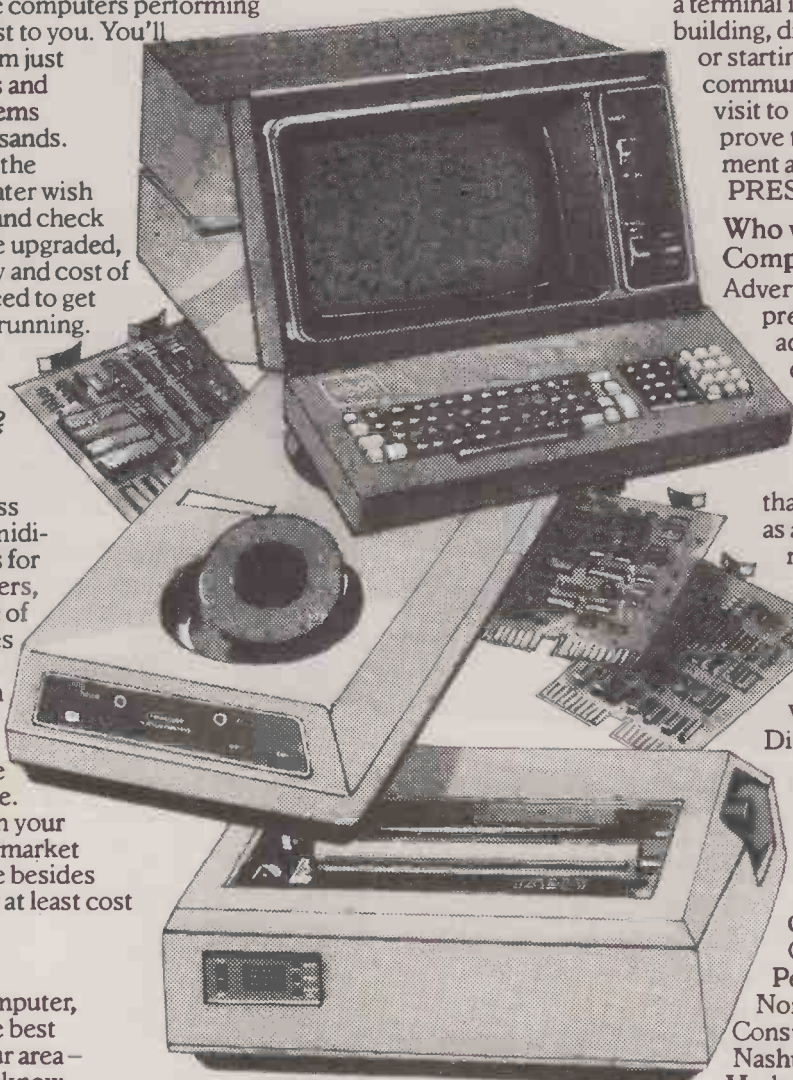

- Midlectron, Micro Media, Micro Data Products, Micro Centre, Micro Bits, MCS Mini Computer Systems, Lynwood Scientific Developments, Lyme Peripherals, Linn Products, Information Equipment Maintenance, ITT, ICS, Harwoods Business Machines, Hamilton Rentals, John Goldsmith, General Audio & Data Communications, Geest Computers, GEC Computers, Excel, Eurocom, Equinox, Digidata, Digico, Datum, Data Design Techniques, DRG Business Machines, DML, Cytek, Cost Effective Computing, Corner Computer Services, Computing, Computer Workshop, Computer Weekly, Computer Management, Computer Ancillaries, Computastore, Comp

MARKET '80

Shop, Commodore Business Systems, Comma Computers, Cole Electronics, Cifer Systems, Camden Electronics, CPS Data Systems, CPN, C.A.R. Business Systems, Byte Shop, Benson Electronics, BL Systems, B & B Computers, Andrews Industrial Equipment, Anadex and A.I.R.

Accountant?

If accounts, payroll, invoicing, credit control, ledger maintenance . . . figure in your life, then an hour or two at Computermarket should be an absolute must. A micro-computer can cost as little as a calculator did just a few short years ago. Trial balance and Profit and Loss statistics can be generated at the touch of a few buttons. Computers can cost hundreds or hundreds of thousands of pounds, save or even sometimes, heaven forbid, squander. You should know what computers are doing today, you might want one or have to use one tomorrow. Your advice may be sought – should be sought – by your own company or that of a client. Admission to Computermarket will cost you nothing, but could very well be worth a great deal in the future.

Data processing manager?

How much would a ten per cent saving on your stationery budget mean to your annual costs? There may be an exhibitor who could achieve that if the two of you met. Is your next peripheral going to be supplied on the most favourable terms? A visit to Computermarket will give you the confidence that you are doing the best for your company. Wouldn't it help if only other Managers in your company could see what it was you were talking about when describing printers/plotters/displays/. . . ? Why not bring them along to Computermarket and show them what you've told them about? Does your chief analyst realise how software packages can be run on your hardware? Wouldn't you both benefit from a visit to Computermarket?

Your own business?

Like it or not, computers are affecting your business and that of your clients, suppliers and competitors. A computer can offer the businessperson much more than automated accounting. It can provide accurate, up-to-the-minute details on the performance of the company, flash warning signals over stock levels, credit-worthiness, supplier shortfalls . . . handle payroll, revenue and VAT returns . . . generally give you more time to run the business you know rather than processing paperwork. See the systems at Computermarket.

Computerising correspondence?

Computer control has received a lot of publicity since the advent of the silicon chip, but micro-processors have also made an impact in the office. Word Processors are able to increase the efficiency of typists to varying and often staggering degrees. Where repetition occurs in letters, reports, contracts, etc., a Word Processor can frequently pay for itself in a matter of months. Many of the small business computer systems now available include a word processing facility, thereby offering what is almost a complete 'work processing' system for a cost equivalent to, say, a new company car. Witness work processing at Computermarket.

In the Midlands?

Computermarket '80 opens at the Albany Hotel, Smallbrook Queensway, Birmingham on the 4th, 5th and 6th March between 10 am and 5 pm daily. The Albany Hotel has excellent facilities and is very conveniently located for car parks and New Street Railway and Bus Stations.

In the North West?

The Manchester venue of Computermarket '80 is the New Century Hall (at the foot of the C.I.S. building) in Corporation Street, opposite Victoria Station, close by car parks and connected by bus with the Piccadilly Station. Computermarket – North West is open 11th, 12th and 13th March 10 am to 5 pm.

In Scotland?

Regarded as Glasgow's finest hotel, the Albany in Douglas Street (on the corner of Bothwell Street) houses Computermarket '80 in Scotland. The hotel is within walking distance of the major railway stations and well provided with car parking and motorway access. Computermarket – Scotland is on 18th, 19th and 20th March between 10 am and 5 pm each day.

In London?

Biggest of all the Computermarket '80 venues is at the West Centre Hotel, Lillie Road, London SW6. The West Centre Hotel is a few minutes walk from West Brompton underground station and is also convenient for the Earls Court underground. Limited car parking is available at the hotel itself. For those visiting London Computermarket is open 25th, 26th and 27th March as with all venues, the exhibition is open from 10am to 5pm each day.

For FREE Admission and complimentary catalogue, complete the coupon and return it to:
Couchmead Limited,
42 Great Windmill Street,
London W1V 7PA.



Name _____
Job Title _____
Organisation _____
Address _____
Postcode _____

COMPUTERMARKET '80

It is regretted that in order to preserve the businesslike nature of Computermarket, admission is not open to persons under 18 or to student parties.

"The trade are going over the moon about it..."



**Integrated Stock-Control,
Invoicing and Sales Accounts.**

**Up to 4,400 items and
accounts handled
simultaneously.**

TRADER:

A powerful, real-time stock-control, invoicing and sales-accounts package with full management information, comprehensive reports and flexible analysis.

Simple to use, TRADER can be operated by any member of staff without previous computer experience.

FUNCTIONS:

TRADER is totally interactive. Stock levels, account balances, sales totals, etc. are instantly and automatically updated with each transaction. VAT, discounts, gross-profit, etc. are accurately calculated as each invoice, credit-note or other document is produced. Sales analysis and sales reports may be produced on demand showing sales volume and

gross-profits against each stock item. Stock reports are available showing stock valuation, low stock, outstanding orders, etc.

Reports showing the current status of all sales-accounts may also be produced on demand.

Full details of any stock-item or sales-account may be looked-up instantly, by any name or code designated by the user.

CAPACITY:

The total capacity of stock-items and sales-accounts is 2,200 (dual-drive version) or 4,400 (quad-drive version). Distribution of records is dynamic so that it is possible to enter as many stock-items or sales-accounts as required up to a combined total shown above. No significant delay in operating time is evident with large data-base.

MICRO PACK:

TRADER is a micro-pack product produced by the Bristol Software Factory specifically for the latest range of Commodore Professional Computer Systems. The aim of Micro-Pack products is to provide truly reliable, powerful and flexible micro-computer software. To that end all systems are fully tested for reliability and suitability in a range of business environments and are fully guaranteed and supported by the Bristol Software Factory.

BRISTOL SOFTWARE FACTORY

MICRO HOUSE,
ST. MICHAEL'S HILL BRISTOL
TEL: 0272 23430

...because they know!"

TRADER Dealers:-

LONDON

Adda Computers Ltd.,
17-19 The Broadway,
Ealing, London W5
01 579-5845

Da Vinci Computers Ltd.,
Classic Offices,
Classic Cinema,
Hendon Central,
London NW4
01 202 9630

Capital Computer Systems,
29-30 Windmill Street,
London, W1P 1HG.
01 637-5551

TLC World Trading,
32/34 Craven Street,
Charing Cross,
London WC2.
01 839 3894

SURREY & MIDDLESEX

Micro-Facilities Ltd.,
127 High Street,
Hampton Hill,
Middx. TW12 1NJ.
01 979 4546

Petalect Electronic Services Ltd.,
33/35 Portugal Road,
Woking,
Surrey.
048 62 69032

Wego Computers Ltd.,
22a High Street,
Caterham, Surrey.
0883 49235

ESSEX

Dataview Ltd.,
Church Street,
Colchester, Essex.
0206 78811

Stuart R. Dean Ltd.,
373 Southchurch Road,
Southend-on-Sea.
62707

D. D. M. Direct Data Marketing Ltd.,
44 High Street,
Brentwood, Essex.
0277 229379

BERKSHIRE & OXFORDSHIRE

C.S.E. (Computers)
12 Wokingham Road,
Reading, Berks.
0734 61492

Oxford Computer Systems,
3 & 5 Oxford Street,
Woodstock, Oxford.
0993 811976

HERTFORDSHIRE & BEDFORDSHIRE

Alpha Business Systems,
89 Railway Street,
Hertford, Herts.
0992 57423

Isher-Woods Computer Systems,
110/112 Leagrave Road,
Luton, Beds.
0582 416202

MMS Ltd.,
26 Mill Street,
Bedford.
0234 40601/2

Buss Stop Computers,
255a St. Albans Road,
Watford, Herts.
0923 40698

MIDLANDS

Betos Systemms Ltd.,
Bennetts House,
155 Mansfield Road,
Nottingham.
0602 48108

Davidson-Richards Ltd.,
14 Duffield Road,
Derby, DE1 3BB.
0332 366803

EAST ANGLIA, LINCOLNSHIRE & NORTHANTS

H.B. Computers Ltd.,
22 Newland Street,
Kettering, Northants.
0536 83922

WEST MIDLANDS, BIRMINGHAM, STAFFORDSHIRE & WARWICKSHIRE

Cliffstock Ltd.,
10/12 Princess Street,
Wolverhampton.
24221

Computer Services Midlands Ltd.,
Refuge Assurance House,
Sutton New Road,
Erdington,
Birmingham.
021 382 4171

Camden Electronics,
1st Floor,
462 Coventry Road,
Small Heath,
Birmingham.
021773 8240

System Micros Ltd.,
Lloyds Bank Chambers,
7 Park Street,
Shifnal,
Shropshire,
0952 460214

Business & Leisure Microcomputers
16 The Square,
Kenilworth,
Warwickshire.
0926 512127

NORTH WEST & NORTH WALES

O.B.E. (Chester) Ltd.,
Executive House,
Pierce Street,
Queensferry,
Deeside, Clwyd.
0244 817277

Rockliff Bros. Ltd.,
2 Rumford Street,
Liverpool.
051 521 5830

MANCHESTER

Cytek (UK) Ltd.,
12 Exchange Hall,
Corn Exchange Buildings,
Manchester.
061 832 7604

**Sumlock Electronic
Services (M/c) Ltd.,**
198 Deansgate,
Manchester.
061 834 4233

LANCASHIRE & CHESHIRE

Catland Computers,
Green Lane,
Wilmslow,
Cheshire,
0625 527166

Fylde Business Machines Ltd.,
28/30 Watery Lane,
Preston, Lancs.
0772 731001

CUMBRIA

Microcomputers Ltd.,
Borwick Fold House,
Crook,
Kendal.
09662 4107

YORKSHIRE & NORTH HUMBERSIDE

**Ackroyd Typewriter & Adding
Machine Co.,**
59 Leeds Road,
Bradford, 1. W. Yorks.
0274 31835

Micro Processor Services,
139 Beverley Road,
Hull, Humberside.
0482 23146

Sheffield Computer Centre,
225 Abbeydale Road,
Sheffield.
0742 53519

NORTH EAST

R. Ward & Sons,
Halifax Road,
Dunston Ind. Estate,
Gateshead, Tyne & Wear.
0632 605915

SOMERSET & DORSET

Stage One Computers,
6 Criterion Arcade,
Old Christchurch Road,
Bournemouth, Dorset.
0202 23570

GLOUCESTERSHIRE

Beam Business Centres,
27 Pitville Street,
Cheltenham, Glos.
0242 45414

AVON

The Bristol Computer Centre,
Micro House,
139 St. Michael's Hill,
Bristol.
0272 23430

Radan Computational Ltd.,
19 Belmont,
Lansdown,
Bath, Avon.
0225 318483

DEVON & CORNWALL

A. C. Systems,
53 Magdalen Road,
Exeter, Devon.
0392 71718

J. A. D. Integrated Services,
21 Market Avenue,
Plymouth.
0752 62616

**Jeffrey Martin Computer
Services Ltd.,**
76/78 Fore Street,
Newquay, Cornwall.
063 73 2863

Devon Computers,
81 Upper Manor Road,
Paignton, Devon.
0803 526303

SCOTLAND

Pilgrim Business Machines Ltd.,
10 Albert Street,
Aberdeen.
0224 55104/5

Thistle Computers,
39 Albert Street,
Kirkwall,
Orkney.
0856 3140

IRELAND

**Medical Scientific Computer
Services Ltd.,**
Altona Road,
Lisburn,
Co. Antrim, N. Ireland.
084 62 77533

ISLE OF MAN

Resource Planning Ltd.,
Goldie House,
Upper Church Street,
Douglas, Isle of Man.
0624 424778

THE BRISTOL SOFTWARE FACTORY

• Circle No. 105

aculab Ltd

HIGH-QUALITY PRINTOUT FOR YOUR WORD-PROCESSING SYSTEM

The ACULAB 735P, a fully self-contained interface for IBM golfball output typewriters and printers.

Parallel model accepts 7-bit ASCII data via a Centronics compatible connector.

Serial model accepts RS232/V24, selectable Baud rates. Parallel model may be retro-fitted with serial board.

Programmed for 7 different typehead layouts, covers all common golfballs and an ASCII ball, switch selectable from the front panel.

STOP/GO switch, ONLINE/OFFLINE switch, also online/offline under software control.

Parallel £155-00 + VAT
Serial £205-00 + VAT

Accessories and cables available for use with PET/SORCERER/TRS-80 (with or without expansion interface) APPLE/ITT/RML380Z etc., etc.

Wiring and testing service for typewriters and printers.

Typewriters and printers available wired and tested and ready to go.

aculab Ltd.

24 Heath Road,
Leighton Buzzard, Beds.
LU7 8AB

Trade enquiries welcome.

For further information
Telephone. 0525-371393.

• Circle No. 106

SUPPORT MEMBERS OF THE COMPUTER RETAILERS ASSOCIATION . . .



THEY WILL SUPPORT YOU.

For further details on the associations aims, membership, code of conduct etc.

Please contact: Ms. Heather Hodgson,
47, Creswell Road, Newbury, Berkshire.
Tel. (0635) 42486

• Circle No. 107

Apple or PET? We are West London's specialists for both.

apple

APPLE II EUROPLUS 16K	£750.00
DISC DRIVE WITH CONTROLLER	£398.00
DISC DRIVE WITHOUT CONTROLLER	£355.00
16K ADD ON MEMORY	£ 69.00
HITACHI 9" BLACK & WHITE MONITOR	£127.00
EUROCOLOUR CARD	£ 69.00
PASCAL LANGUAGE CARD	£296.00
ALF MUSIC SYNTHESISER CARD	£215.00
TCM 100 SILENT 40 COLUMN PRINTER	£243.00
TCM 100 SILENT 80 COLUMN PRINTER	£395.00
TCM INTERFACE FOR PET OR APPLE	£ 49.00

FROM

adda

PET

NEW PET 8K WITH LARGE KEYBOARD	£495.00
PET 3016 16K COMPUTER	£675.00
PET 3032 32K COMPUTER	£795.00
PET 3040 DUAL DRIVE FLOPPY DISK	£795.00
PET 3022 DOT MATRIX PRINTER	£645.00
PET C2N TAPE DECK	£ 55.00
24K EXPANSION MEMORY	£320.00
COMPUTHINK 400K DISK DRIVE	£895.00
COMPUTHINK 800K DISK DRIVE	£1145.00
TELETYPE 43 PRINTER	FROM £860.00
QUME SPRINT DAISYWHEEL	FROM £2100.00

FROM

adda

Adda Computers, 17-19 The Broadway (between W.H. Smith and Burtons), Ealing, London W.5. Tel. 01-579 5845
Open 09.00-18.00 Monday to Friday; 10.00-16.00 Saturdays.

• Circle No. 108

OUR SYSTEMS CAN GROW ON YOU

When you buy one of our low price microcomputer development systems you not only get a fully burnt-in and tested system designed and manufactured to industrial standards. You also get access to an ever-increasing range of software tools. And if you require a VDU or printer now or later, there is a selection of these and other peripherals from which to choose. So your system can grow and grow.

Our systems start to grow on you at £1450. This buys you a 32KB system with dual 5¼ inch double density floppy drives. At £1675 you can have a 48KB system or for £2495 one with the extra memory storage provided by dual 8 inch double density floppy drives. All the systems are based on the powerful Z80 microprocessor and S100 bus structure and can provide memory management. Cartridge disc drives are available providing up to 40MB of storage.

The prices include an operating system and language, in this case CP/M and C-BASIC, to

give a typical system cost. But with slight cost adjustment the software options are:

Operating Systems

- CP/M ● PASCAL ● CAP MICROCOBOL BOS
- Multi-User, Multi-Tasking Operating Systems

Languages

- C-BASIC COMPILER ● M-BASIC ● FORTRAN-80
- COBOL-80 ● PASCAL ● CIS-COBOL

There is also a word and text processing system available that is ideal for report writing.

You simply take your pick from the software options. Or visit our London showroom and see the systems demonstrated.

SYSTEMS WITH CP/M AND C-BASIC: 32KB + Dual 5¼ inch Floppies: **£1450**

48KB + Dual 5¼ inch Floppies: **£1675**

48KB + Dual 8 inch Floppies: **£2495**

Prices exclude VAT. Nationwide maintenance facilities available.



EQUINOX

COMPUTER SYSTEMS LTD.

Kleeman House, 16 Anning Street,
New Inn Yard, London EC2A 3HB
Tel: 01-739 2387/9 & 01-729 4460

THE ELECTRONIC REVOLUTION

SPECIAL OFFER — 8K PET £495 ex. VAT (+ p&p £15 in U.K.)

★ SPECIAL VALUE! GAMES GALORE!

For your PET 20 different games on disk or tape for £23 inc. VAT (+ 50p p&p) — media included.

It sounds like a steal! All originals, most games with super graphics.

- | | | |
|--------------------|--------------------|------------------|
| 1. Cannibal Island | 8. Junior Hangman | 15. Howitzer |
| 2. U-Boats | 9. Death Race 2000 | 16. Doodlebug |
| 3. Minefield | 10. Ski Slopes | 17. Brands Hatch |
| 4. Dth + Ilo | 11. Master Mind | 18. Battlestar |
| 5. Draughts | 12. Fly Swat | 19. Dambuster |
| 6. Star Wars | 13. Evens | 20. Rugby |
| 7. Hangman | 14. Rocket Attack | |

Also: Serial ASCII unidirectional interface for PET to RS232c
(Turn your PET into a wordprocessor) **£92 inc. VAT (+£1 p&p)**

Well Ring my Chimes! DOOR CHIMES. 24 fantastic electronic tunes to amaze your friends when they 'ring your bell' — Complete **£12.50 inc. VAT (+ £1 p&p)**

PET DEMO CREATOR

Create your own personalised automatic demonstration — large characters all built-in — just say what you want to say! A new demo everyday **£10.**

MAIL ORDER

Written orders with cheque or Access/Visa No. to:

6 Criterion Arcade, Old Christchurch Road, Bournemouth.

Please supply:

ITEM QUANTITY

AMOUNT £ CHEQUE NO.

Name ; Ad dress ACCESS/VISA NO.

• Circle No. 110

PETAID

PET SOFTWARE WITH
A FUTURE. EVERY PET
SHOULD HAVE ONE



LOOK NO PROGRAMMERS!

PETAID — THE ANSWER TO A USER'S PRAYER

Advantages of PETAID

Every program is structured around PETAID which means:

1. Common line numbers
2. Common variables
3. Common subroutines
4. Common systems

which means:

1. Easy to implement
2. Easy to add to
3. Easy to alter
4. Easy to support

which means:

1. Lower cost of implementation
2. Lower cost of system
3. Lower cost of alterations
4. Lower cost of support

All your installed programs could have an identical structure — think how easy subsequent support will be — programs in Days not Weeks. Weeks not Months. Months not Years —

PETAID FEATURES: Create Files, Insert, Amend, Delete, Display, Print, Search, Copy, Examine, Extract and Sort — Good Documentation

NOW AVAILABLE FOR:

Sequential Commodore Disks
Random Access Commodore and Compu/Think Disks
Printers Commodore, Anadex, Gume

Tape based Version only £46

Sequential Disk based version £149.50

Random Access Disk based version £149.50

Soon to be available and PETAID compatible!

1. Various Print generators
2. Search and Extract new file
3. Transaction Handlers

ALSO	
Word Processor	£69.00
Word Processor with mailing	£92.00
Quote Processor	£69.00
Mailing List	£57.50
Estate Agents Pack:	
Applicants/Word Processing/Properties	£517.50
Stock	£28.75
Incomplete Records	£1725.00
Pension Calculations	£57.50
Bond 10+	£57.50
All prices shown are VAT & P&P UK inclusive	

MAIL ORDER

Written orders with cheque or Access/Visa No. to:

STAGE ONE COMPUTERS 6 Criterion Arcade, Old Christchurch Road, Bournemouth.

Please supply: ITEM.

QUANTITY

AMOUNT £ CHEQUE NO.

Name ACCESS/VISA NO.

Address ACCESS/VISA NO.



• Circle No. 111



News from ROSTRONICS



Teletype 43

New Low Price £775 + VAT



True 30 cps Data Printer

Versatility, reliability and economy are key points already established by Teletype[®] and their range of terminal products. The Model 43 enhances the range by offering a true 30 cps serial asynchronous keyboard printer ideal for a wide range of applications

Applications

- * time sharing
- * input/output
- * point-to-point data communications
- * OEM systems

INTEGRAL DATA SYSTEMS

MODEL 440 PRINTER

THE PAPER TIGER

£585.00 + VAT

- Up to 198 CPS
- 1.75" to 9.5" Adjustable Tractor Feed
- Parallel and Serial Interface
- 96 Character ASCII Set
- 132 columns- 6 or 8 lines/inch
- Eight software selectable Character sizes
- 110, 300, 600, 1200 Baud Rate

For the graphic option add £120.00 + VAT



BULK ERASER

£5.10p

+ VAT

DISKETTS

5¼" £3.00 each
For 10 £25.00
+ VAT

ROSTRONICS MEMORY EXPANSION KITS FOR TRS-80, Apple, & Exidy 4116's

Everything a person needs to add 16K of memory. Chips come neatly packaged with easy to follow directions. In minutes your machine is ready for games and more advanced software.

£55.00 + VAT

Software

Advanced Personal Finance	£10.00
Cash Register	£7.00
Electric Pencil (tape)	£65.00
Electric Pencil (disc)	£102.00
Adventure (disc)	£15.00
Backgammon	£5.00
Cribbage	£5.00
Dog-Star Adventure	£5.00
Kamikaze	£5.00
Library-100	£37.00
Mission Impossible	£5.00
'Round the Horn	£5.00
Safari	£5.00
Santa Paravia en Fiumaccio	£5.00
Sargon Chess	£12.00
Slalom	£5.00
Sink'um	£5.00
Star Trek 3	£8.00
Tarot	£5.00
Ten Pin Bowling	£5.00
Time Bomb	£5.00
Treasure Hunt	£5.00
Troll's Gold	£3.00
TRS-80	£3.00
X-Wing Fighter	£5.00
Zone Hockey	£5.00

+ VAT

TANDY'S NEW PRICES

16 K Lever £510.00
Expansion Interface £195.00
+ VAT

IBM REFURBISHED RECEIVE ONLY TYPEWRITERS

With
TANDY TRS 80 Interface

£595.00
+ VAT

TRS 80 CABLES

Disc Drive Cables

2 Drives £15.50 + VAT
4 Drives £25.00 + VAT
Printer Cable £15.50 + VAT

It's Here At Last...

learn how to use Level II!

£11.00 (soft cover)

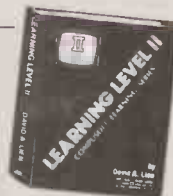

Written by the author of your Level I Users Manual, LEARNING LEVEL II picks right up where the Level I Manual leaves off. It also supplies the changes needed to make the Level I Manual compatible with your Level II TRS-80.

LEARNING LEVEL II covers all Level II BASIC beyond Level I, plus much more. It shows you how to use the Editor, explains what the many error messages are really saying, and leads you thru conversions of Level I programs to Level II.

Dual cassettes, printers, the Expansion Interface with clock and other features are explained in the same easy-to-learn style that made the Level I Manual famous. LEARNING LEVEL II was created specifically for your Level II TRS-80!

BOOKS

Basic Computer Games	£5.50
Basic Basic	£5.70
Best of Byte 1	£6.50
Best of Creative Computing 1	£5.50
Best of Creative Computing 2	£5.50
Creative Computing Magazine	£1.50
Kilobaud Magazine	£1.50
Softside Magazine	£1.50

BASIC HANDBOOK £11.00



Is TRS-80 Level II covered — YES!
Is PET covered — YES
Is Apple covered — YES
Sorcerer, Altair, Imsai, Etc. YES.... and over 50 more!



8" DRIVES FOR THE TRS-80 AND THE SORCERER

This 8" Dual Drive, Double Density, Single or Double sided, Floppy disk system allows the TRS-80 and the Sorcerer access to either 1 or 2 megabytes of high speed disk storage.

The drives are designed to use the industry's CP/M operating system and a special TRS-80-compatible version of CP/M is included with the unit.

The controller does not require any memory space in the system RAM so a full 48K is available, which is approximately a 30% improvement on the existing Tandy system.

The price of the 1 Megabyte drive is £1350 + VAT
and the 2 Megabyte drive is £1750 + VAT

DIRECT MAIL ORDER FORM

ROSTRONICS LTD
115-117 Wandsworth High Street, Telephone: 01-870 4805
London SW18, England. Telex: 8813089 INTPRM G

Please send

My cheque for is enclosed.

Please debit my Access/Barclaycard/Mastercharge/Visa Card No.

Name

Address

City Post Code

I understand my order will be shipped promptly.

My computer is a



• Circle No. 112

RESEARCH RESOURCES LTD.

You are already out of date —
2nd generation micro-computers are here.



- Two expandable computer systems: 32-56K RAM, 128-768K RAM
- 6809 16/8 bit processor — more than twice as powerful as 8080/Z80
- Three disc systems — 170k, 2.5 Megabyte and 64 Megabyte
- FLEX operating system (50 much better than CP/M)
- Both Multi-user and Multi-tasking/Multi-user operating systems
- Scientific Basic and Business BASIC, PASCAL, PILOT, Macro-Assembler, Editor, Debug plus BASIC pre-compiler available. FORTRAN soon
- Write or phone for full information and demonstrations of the entire range of 6809 computer systems:

Research Resources Ltd
40 Stonehills, Welwyn Garden City, Herts.
Tel. Welwyn Garden City (07073) 26633 (24 hours)

• Circle No. 113

MICRODIGITAL BOOKS

BEST SELECTION-BEST PRICES-BEST SERVICE

25 Brunswick Street, Liverpool 2. Tel. 051-236 0707 (Mail Order)
*051-227 2535 (All Other Depts)

Accounts Payable & Receivable	£9.95	Basic — a unit for Secondary Schools	£4.45	8080 Programmer Pocket guide	£1.95	Home Computers: A Beginners Glossary and Guide	£4.95	Micro/Computer Interface with the 8255 PPI Chip	£10.00
Active filter Cookbook	£10.90	Basic Programming	£6.95	8080A Bugbook	£7.65	Hobby Computers Are Here	£3.95	Microformula (TM)	£2.95
Adaptize Info. Processing	£8.75	Basic Primer	£6.95	8080 Programming for Logic Design	£5.95	Incredible Secret Money Machine	£4.75	Microsoft (TM) Basic	£7.00
Advanced Basic	£4.00	Collection of Programming Problems and Techniques	£12.00	8080A/8085 Assembler Language Programming	£6.95	Interface Circuits Data Book	£3.50	Microprocessor Basics	£7.60
Algorithms & Data Structure Equals Programs	£14.00	Computer Crime	£12.00	8080/8085 Software Design for Beginners	£7.65	Intro to Artificial Intelligence	£14.80	Micros — New Directions for Designers	£7.60
Anatomy of a Compiler	£15.00	Computer Data Directory	£3.98	8080 Machine Language Programming	£5.10	Intro to Computer Prog	£4.75	Microprocessors Data Manual	£5.50
Apl. — An Interactive Approach	£9.50	Computer Lib/Dream machines	£5.95	8080 Microcomputer Experiments	£10.25	INTRODUCTION TO MICROCOMPUTERS.		Micros for Business Applications	£7.15
Artificial Intelligence	£12.00	Computer Models of Thought and Language	£17.00	8080 Standard Monitor	£9.95	Vol 0	£5.95	More Basic Computer games	£5.50
Artist & Computer	£3.96	Computer Power and Human reasons	£4.76	8080 Standard Editor	£9.95	Vol I	£5.95	Microcomputer Potpourri	£1.75
Art Computer Programming	£9.50 S/B	Computer resource book Algebra	£4.00	8080 Standard Assembler	£9.95	Vol II	£8.95	Modern Operational Circuit Design	£18.60
Vol. 1.	£16.45 H/B	Computer Science a First Course	£15.00	8080 Standard Assembler	£9.95	Vol III	£11.95	Microprocessor Basics	£7.60
Art Computer Programming		Computer Science Programming in Fortran IV	£7.80	8080 Standard Assembler	£9.95	Intro to Personal & Business Computing	£4.95	Microprogrammed Apl Implementation	£14.75
Vol. 2.	£16.45	Computer/Science Projects and Study problems	£8.75	8080 Standard Assembler	£9.95	Intro to Prog. Prob. Solving with Pascal. Schneider Et Al	£8.50	Mos Memory Data Book	£2.80
Art Computer Programming		Concurrent Pascal Compiler	£6.40	8080 Standard Assembler	£9.95	Instant Basic	£7.20	Microprocessor Encyclopedia	£7.45
Vol. 3.	£16.45	Conference Proceedings of the 1st West Coast Computer Fair	£9.56	8080 Standard Assembler	£9.95	Introduction to Basic	£7.15	9900 Family systems Design & Data Book	£7.95
Assembley Level Programming for small computers	£12.76	Conference Proceedings of the 2nd West Coast Computer Fair	£9.56	8080 Standard Assembler	£9.95	Interfacing and Communications	£4.95	1975 U.S. Comp Chess	£4.75
Analysis and design of Digital Circuits and Computer Systems	£16.40	Conference Proceedings of the 3rd West Coast Computer Fair	£9.58	8080 Standard Assembler	£9.95	Introductory Experiments in Digital Electronics Vol I	£8.75	1976 U.S. Comp Chess	£4.75
Accent on Basic	£4.95	Consumer Guide—Personal Computers & Micros.	£5.00	8080 Standard Assembler	£9.95	Introductory Experiments in Digital Electronics Vol 2	£7.75	NCR Basic Electronics	£7.15
About Computers	£6.95	Content Addressable Parallel Processors.	£11.20	8080 Standard Assembler	£9.95	Introduction to TRS — 80 Graphics	£5.25	NCR Data Communications	£7.15
Active Filters	£6.45	Computer Dictionary (sams)	£6.95	8080 Standard Assembler	£9.95	Instructor's manual for Fortran Programming	£6.95	NCR Data Processing	£6.35
Analogue/Digital Experiments	£7.15	Computer Dictionary & Handbook	£11.95	8080 Standard Assembler	£9.95	Illustrating Basic	£2.25	Nascom 1 — Hardware Notes	£1.50
A guided tour of Computer Programming in Basic.	£4.16	Computer & Program Guide for Engineers.	£9.45	8080 Standard Assembler	£9.95	IC Optamp Cookbook	£8.95	Nascom 1 — Seminar Notes	£1.50
A quick look at Basic	£4.45	Computers for the Physicians Office	£15.50	8080 Standard Assembler	£9.95	Introduction to Microprocessors & Computing	£2.40	Optoelectronics Data Book	£3.50
Apple II Operators Manual	£5.50	Computerisation for small Business	£9.95	8080 Standard Assembler	£9.95	Kim 1 Users Manual	£5.00	Osbourne Updated Subscriptions	
Apple II Integer Basic manual	£3.55	Computer Quiz Book	£5.45	8080 Standard Assembler	£9.95	Line Control Circuits Data Book	£4.00	Vol. 2, (6 issues)	£18.95
Apple II Applesoft Extended Basic Manual	£5.75	Computer Programs that Work.	£2.95	8080 Standard Assembler	£9.95	Link 68 — M6800 Linking Loader	£5.50	Vol. 3, (6 issues)	£18.95
Advanced Business, Billing, Inventory, Investments, Payroll	£26.95	Computer Music	£7.00	8080 Standard Assembler	£9.95	Little Book of Basic Style	£4.75	Vol. 2 & 3, combined	£30.00
An Introduction to Your new Pet.	£1.00	Computer Data Directory	£3.98	8080 Standard Assembler	£9.95	Linear IC Principles Experiments	£7.16	Binders 2 or 3	£5.75
Basex	£5.60	Computer Rage (a board game)	£6.95	8080 Standard Assembler	£9.95	Math Elements for Computer Graphics	£10.40	Pascal User Manual & Report	£5.25
Basic A Hands on Method	£6.50	Claudia's Circuit Cellar	£5.60	8080 Standard Assembler	£9.95	Microcomputer — Based Design	£8.00	Payroll with cost accounting	£12.00
Basic and the Personal Computer	£10.00	Designing with TTL Circuits	£24.80	8080 Standard Assembler	£9.95	Microcomputer Handbook	£15.96	Power Semi-conductor Data Book	£7.50
Basic, Basic.	£4.80	Design of Well Structured Prog's	£10.00	8080 Standard Assembler	£9.95	Microcomputer Primer	£6.35	The Mighty Micro	£5.75
Basic Computer Games Micro.	£5.50	Dictionary of Microcomputing.	£10.00	8080 Standard Assembler	£9.95	Microelectronic	£3.25	Z — 80 Programming Manual	£4.50
Basic from the Ground Up	£7.00	Digital Computer Fundamentals.	£14.25	8080 Standard Assembler	£9.95	Microprocessor Solving Using Pascal	£7.50	TTL Databook	£7.00
Basic Microprocessors and the 6800.	£7.20	Dr. Dobbs Journal Vol. 1.	£10.00	8080 Standard Assembler	£9.95	Microprocessor Interfacing techniques	£7.95	TI Workbooks (1-6) each	£3.00
Basic with Business Application	£8.40	Digital IC Equivalents & Pin Connections.	£1.25	8080 Standard Assembler	£9.95	Microprocessor Lexicon	£2.00	TLS 6800 Tracer	£4.80
Basic with style/Programming proverbs.	£3.60	Designing M/Computer Systems	£5.40	8080 Standard Assembler	£9.95	Microprocessor System Design	£14.00	TTL Cookbook	£6.95
Basic Workbook	£3.70	Editor/Assembler Systems for 8080/8085 Based Systems	£11.96	8080 Standard Assembler	£9.95	Microprocessor From Chips to Systems	£7.50	Peanut & Jelly Guide to Computing	£6.45
Best of Creative Computing Vol. 1.	£6.95			8080 Standard Assembler	£9.95	Mind Appliance	£4.75	The Best of Micro	£5.50
Best of Creative Computing Vol. 11.	£6.95			8080 Standard Assembler	£9.95	Modern Operational circuit Design	£18.60	Z — 80 and 8080 Assembly Prog.	£4.80
Byte Book of Computer Music	£7.00			8080 Standard Assembler	£9.95	Mondeb M6800 Monitor/debug Microcomputers at a Glance	£3.50	6500 Programming manual	£10.50
Beginners Glossary and Guide	£5.75			8080 Standard Assembler	£9.95			6500 Hardware Manual	£10.50
Beginners Basic	£7.50			8080 Standard Assembler	£9.95			Software Gazette	50p
Byte Vol 1	£8.45			8080 Standard Assembler	£9.95				

• Circle No. 114

The small business system that won't let you down

VECTOR MZ FROM COMPUTASTORE

Computastore has combined the powerful Vector MZ microcomputer with the reliability of proven accounts packages to bring you the benefits of a Small Business Computer at a price you can afford. With a high speed printer, the total system costs £5500, including installation and training – no extras to pay.

The integrated accounts packages provide the flexibility and ease of operation that first time users demand. Operator training is provided at YOUR premises, using YOUR data to get your system working within days. And because our accounts software has been developed in-house, the standard packages can easily be tailored to meet your needs exactly.



■ **SALES LEDGER:** Open item system, produces statements and current aged debtors balance at any time – not just at month end.

■ **PURCHASE LEDGER:** Open item system, produces aged creditors balance and remittance advices at any time – you choose the items you want to pay.

■ **NOMINAL LEDGER:** Links with both sales and purchase ledgers. Compares actual with budget, and with same period previous year.

■ **ONE OFF SOFTWARE:** We will be pleased to quote for any other commercial application.

■ **WORD PROCESSING OPTION:** Combine your word and data processing on the same system.

TECHNICAL OVERVIEW:

Vector MZ: Industry standard CP/M operating system, 48K RAM, 630K Disk Drives, Fast Z80 microprocessor, S100 bus.

Mindless Terminal:

High quality 80 x 24 upper and lower case display, Typewriter style keyboard, with numeric keypad.

Texas Instruments 810:

150 c.p.s. high quality dot matrix printer.

ONLY £1,700 32K Vector MZ complete with 630K disk drives, CP/M, C/BASIC and NAD.

Full Range of Low Cost Accessories by Mail Order.

*Barclaycard and Access welcome.

HARDWARE, SOFTWARE and ACCESSORIES
sold either as complete systems or separately.



All goods in stock NOW, so why not call in for a demonstration, or ring or write for further details.



Computastore

Software That Means Business

16 John Dalton Street
Manchester M2 6HG
Tel: 061-832 4761

• Circle No. 115



**CRYSTAL ELECTRONICS
CC ELECTRONICS**

**The newest Z80 Basic!
XTAL Basic 2-2**

HAS to be the best yet for your Nascom 1 or 2
All the usual features of other 8K floating-point BASICs
Plus: **Extra commands/functions—INCH, KBD, CMD\$
ON ERR GOTO, ERR, PI, CLOAD? (tape verify)**

And Add up to 64 reserved words of your
choosing—Now put your own disc, tape, control,
graphics commands, etc for the ULTIMATE in BASIC
flexibility! Fully upward compatible with version 2.1
(see earlier Ads). Can be easily adapted to most Z80
systems. Works with T2, B-BUG, T4 and NAS-SYS
monitors. Existing version 2.1 users—Return your
original tape (less manual) with 50p P & P and we will
update it FREE of charge!

Price: still only £35 + VAT!

CREED PRINTER INTERFACE

For NASCOM or APPLE—lowest cost hard copy!
Complete kit of parts (with software) £18 + VAT.

16 CHANNEL RELAY BOARD

Now in stock for NASCOM 1/2. For £49.95 + VAT
Sixteen switched (isolated) channels for many control
applications. This kit will greatly increase the flexibility
of your NASCOM.

Members of Computer Retailers Association & Apple Dealers Association

Shop open 0930-1730 except Wed. & Sun.

40 Magdalene Road, Torquay, Devon, England. Tel: 0803 22699

Access and Barclaycard welcome.



COMPUTERS
AND
COMPONENTS



• Circle No. 116

Software for CP/M

QUALITY PACKAGES DIRECT FROM U.S.A.

CBASIC-2	£75
Extended Disk Basic for Commercial work	
WORDSTAR	£250
Ultimate in micro Word Processing Software	
SELECTOR III-C2	£185
Best selling DBMS	
SUPERSORT I (relocatable & executable)	£140
SUPERSORT II (executable only)	£115
SUPERSORT III (as II but without Select/Exclude)	£85
Sort/merge and select/exclude	
WORDMASTER	£85
Superior full screen text editor	
TEX-WRITER	£50
Output formatter	
IBM-CP/M COMPATIBILITY	£110
3740 data exchange with CP/M	

CASH WITH ORDER

ADD 50p/Item P&P (Min £1) and VAT (15%)

STATE Computer and Disk size/format

Due to Dollar fluctuations, Prices subject to change without notice.

Telesystems Ltd

P.O. BOX 12, GT. MISSENDEN BUCKS HP16 9DD
02406 5314

• Circle No. 117

WE OFFER A COMPLETE SERVICE!

When you buy a computer from us — we don't give you the box and wave goodbye.

We realise this is a major purchase for a Company and take the time to find out your requirements, design your computer system and write the software, or if you prefer to write your own, we will always be available to advise you.

You can buy a wide range of fully-documented packages — Word Processing/Purchase & Sales Ledgers/ Stock Control/Incomplete Records/Medical Systems/Teaching Programs etc.
on Microcomputers such as—

APPLE II from £750
(16K)

A complete business system 48K
Apple, 2 Disk Drives, VDU &
Printer £2,550

MICROSTAR from
£4,950

Multi-user/Multi-task
1.2/2.4 or 4.8 mb.
A complete system with 2 VDUs
& Printer £7,000

ALPHA MICRO from
£9,950

From 1 to 32 terminals.
From 10 mb. to 90 mb. disk
storage.
16-bit processor, Multi-user
operating system.

**We stock a full range of VDUs, Printers,
Computer Stationery, Diskettes, Disk Boxes etc.**

all prices ex VAT.

Come and see us to discuss your requirements and have a demonstration.

MICROSOLVE

Microsolve Computer Services Ltd.
125/129 High Street, Edgware, Middlesex.
Tel: 01-951 0218/9 and 01-951 0210

M1 junction 4/20 mins from Central London

e.g.
**LOW COST
PRINTERM**

matrix printer £695

LEAR SEIGLER
200A matrix printer £1,650

QUME Sprint 5
daisywheel printer £2,115.

• Circle No. 118

ATHENA



The desktop computer that thinks it's a mainframe

Compare these features with micros, minis or even mainframe computers. Then have a guess at the price of putting an Athena on your desk. We can guarantee that, even if you are already very aware of all the latest advances in multi-micro desk top computers, the answer will surprise you.

The Athena can be tailored for personal, educational, business and industrial users. It can stand alone or be connected to larger systems in a distributed processing environment. It is flexible and easily up-graded to meet changes in application requirements.

The basic system starts at £3,380. A typical configuration with 64K, integral dual floppy discs, 150 cps printer and software costs £7,954.

BUTEL-COMCO
Technology for business

- Multi-processing with intelligent buffered peripheral controllers
- 64Kb RAM PROM Memory
- Integral 150 cps matrix printer
- Additional external printers and terminals
- Storage modules from 12 to 300 Megabytes
- Up to 1200 Mb of disc storage
- Integral mini-floppy discs and cassettes
- Remote communications – asynchronous or synchronous
- Powerful multi-tasking operating system (AMOS)
- COBOL, Fortran, BASIC, Pascal and APL compilers
- Proven accounting package in COBOL – Sales, purchase and general ledgers, order entry, invoicing and payroll
- Text editing package

Butel-Comco Limited
50 Oxford Street,
Southampton, Hants. SO1 1DL
Telephone: Southampton (0703) 39890. Telex: 47523

• Circle No. 119

24 TUNE DOOR CHIMES

DOOR TUNES £17.13 + VAT

Waddington's Videomaster announce a doorbell that doesn't go Brrrrringg, Ding Dong or Bzzzzz. Instead it plays 24 different classical and popular tunes. It will play the tune you select for your mood, the season or the visitor you are expecting to call. Door tunes is not only great fun and a wonderful ice breaker, but is also very functional and beautifully designed to enhance your home. There is something for Christmas, something for your continental visitors or your relations from the states, and even something for the Queen. Door tunes is easy to install and has separate controls for volume, tone and tempo.



T.V. GAMES

PROGRAMMABLE £29.50 + VAT. COLOUR CARTRIDGE T.V. GAME.

The TV game can be compared to an audio cassette deck and is programmed to play a multitude of different games in COLOUR, using various plug-in cartridges. At long last a TV game is available which will keep pace with improving technology by allowing you to extend your library of games with the purchase of additional cartridges as new games are developed. Each cartridge contains up to ten different action games and the first cartridge containing ten sports games is included free with the console. Other cartridges are currently available to enable you to play such games as Grand Prix Motor Racing, Super Wipeout and Stunt Rider. Further cartridges are to be released later this year, including Tank Battle, Hunt the Sub and Target. The console comes complete with two removable joystick player controls to enable you to move in all four directions (up/down/left/right) and built into these joystick controls are ball serve and target fire buttons. Other features include several difficulty option switches, automatic on screen digital scoring and colour coding on scores and balls. Lifelike sounds are transmitted through the TV's speaker, simulating the actual game being played. Manufactured by Waddington's Videomaster and guaranteed for one year.



EXTRA CARTRIDGES

ROAD RACE - £8.87 + VAT.

Grand Prix motor racing with gear changes, crash noises

SUPER WIPEOUT - £9.17 + VAT.

10 different games of blasting obstacles off the screen

STUNT RIDER - £12.16 + VAT.

Motorcycle speed trials, jumping obstacles, leaping various rows of up to 25 buses etc

NON PROGRAMMABLE TV GAMES

6 Game - COLOURSCORE II - £13.50 + VAT.

10 Game COLOUR SPORTSWORLD £22.50 + VAT.

CHESS COMPUTERS

STAR CHESS - £85.85 + VAT PLAY CHESS AGAINST YOUR PARTNER.

using your own TV to display the board and pieces. Star Chess is a new absorbing game for two players, which will interest and excite all ages. The unit plugs into the aerial socket of your TV set and displays the board and pieces in full colour for black and white on your TV screen. Based on the moves of chess. It adds even more excitement and interest to the game. For those who have never played, Star Chess is a novel introduction to the classic game of chess. For the experienced chess player, there are whole new dimensions of unpredictability and chance added to the strategy of the game. Not only can pieces be taken in conventional chess type moves, but each piece can also exchange rocket fire with its opponents. The unit comes complete with a free 18V mains adaptor, full instructions and twelve months guarantee.



CHESS CHALLENGER £98.50 PLAY CHESS AGAINST THE COMPUTER.

The stylish, compact, portable console can be set to play at seven different levels of ability from beginner to expert including "Mate in two" and "Chess by mail". The computer will only make responses which obey international chess rules. Casting, on passant, and promoting a pawn are all included as part of the computer's programme. It is possible to enter any given problem from magazines or newspapers or alternatively establish your own board position and watch the computer react. The positions of all pieces can be verified by using the computer memory recall button. Price includes unit with wood grained housing, and Staunton design chess pieces. Computer plays black or white and against itself and comes complete with a mains adaptor and 12 months guarantee.



ELECTRONIC CHESS BOARD TUTOR £17.17 inc. VAT.

A special bulk purchase of these amazing chess teaching machines enables us to offer them at only £19.75 less than half recommended retail price. The electronic chess tutor is a simple battery operated machine that can actually teach anyone to play chess and improve their game right up to championship level. This machine is not only for total beginners but also for established players wanting to play better chess. Unit contains the electronic chessboard with 32 chess pieces, a 64 page explanatory booklet and a set of 32 progressive programme cards including 6 beginners cards, 16 check mate positions, 9 miniature games, 5 openings, 3 end games, 28 chess problems and 7 master games.

DRAUGHTS COMPUTERS

CHECKER CHALLENGER 2 LEVELS £43.00 + VAT. 4 LEVELS £78.00 + VAT.

The draughts computer enables you to sharpen your skills, improve your game, and play whenever you want. The computer incorporates a sophisticated, reliable, decision-making microprocessor as its brain. Its high level of thinking ability enables it to respond with its best counter moves like a skilled human opponent. You can select offence or defence and change playing difficulty levels at any time. Positions can be verified by computer memory recall. Machine does not permit illegal moves and can solve set problems. Complete with instructions, mains adaptor and twelve months guarantee.

PLAY DRAUGHTS/CHECKERS AGAINST THE COMPUTER



FOR FREE BROCHURES - SEND S.A.E

For FREE illustrated brochures and reviews on TV and chess games please send a stamped addressed envelope, and state which particular games you require information on.

Callers welcome at our shop in Welling demonstrations daily open from 9am-5.30pm Mon-Sat 9am-1pm Wed
To order by telephone please quote your name, address and AccessBarclaycard number.
Postage and Packing FREE

AJD DIRECT SUPPLIES LIMITED, Dept. P.C.12 102 Bellegrave Road,
Welling Kent DA16 3DD. Tel: 01-303 9145 (Day) 01-850 8652 (Evenings)

• Circle No. 120

Happy Memories

21L02 450ns	83p	16K Memory Upgrade Kits for TRS-80, Apple and	
21L02 250ns	1.00	Sorcerer all at £64.00	
2114 450ns	4.95		
2114 250ns	5.45	Vero S100 Products:	
4116 300ns	7.25	6 Slot Card Frame with Power Supply	241.36
4116 150ns	7.25	Prototyping Cards (3 types) each	13.66
2708 450ns	7.26	Extender Card	21.70
2716 450ns	23.50	Motherboard with 6 connectors	67.65

IC Sockets:		Ithaca Intersystems Products:		
Pins	Solder	W/W	S100 Z80 CPU Card 4MHz A&T	176.81
8	10p	24p	" " " " 2MHz "	150.94
14	11p	36p	" " " " 2MHz "	30.19
16	12p	39p	S100 Video Display Board A&T	125.06
18	16p	46p	" " " " Bare Board	21.56
20	17p	58p	S100 16 x 2708/2716 A&T	73.31
22	19p	61p	" " " " Bare Board	21.56
24	21p	63p	S100 Proto Board (Plated Through)	21.56
28	27p	70p	See Ithaca's own advertisement for full range	
40	37p	109p	VERBATIM Mini-discs (Pet, TRS-80) etc	21.50

SAA5050	17.75	Cannon MIN-D 25 way connectors: Female	1.65
SAA5020	7.99	Male 1.45 Hoods 57p Other sizes available	
81LS95	1.50	DIN 41612 Euroconnectors 64 way: Female	3.17
81LS97	1.54	Right-angled Male 1.93 Other sizes available	

74LS series:

Lots of them POA DIP Switches: 4, 7 & 8 way all at 85p

We stock a full range of Wire-Wrapping equipment and supplies for you to choose from; we have shelves of books - give us a ring with your requirements and avoid crippling postage charges. Our stocks are too numerous to list here - free price lists sent upon request.

The shop is open from 10 until 6 Monday to Saturday and is worth a visit to catch a surplus bargain - Keyboards at 39.50 today, we may have some left when this gets to print 7 18 slot S100 Mother Boards at 22.50 7 Double Eurocard prototyping boards for a pound.

ALL PRICES INCLUDE VAT. POSTAGE FREE ON ORDERS OVER 10 POUNDS IN VALUE, OTHERWISE ADD 25p. ACCESS AND BARCLAYCARD WELCOME, YOU MAY TELEPHONE WITH YOUR CARD NUMBER AND REQUIREMENTS. TRADE ACCOUNTS ON APPLICATION, GOVERNMENT & EDUCATIONAL ORDERS WELCOME £10 MIN.

19 Bevois Valley Road, Southampton,
Hants. SO2 0JP Tel: (0703) 39267

• Circle No. 121

DISKS : LTT : MEMORY : DISKS : LTT : MEMORY : LTT :

GODBOUT Computer Products

High quality, fast (4 MHz), reliable static S-100 memory boards and other products e.g. -

	Kit	Ass
2708 EPROM chip	£6.25	n/a
2716 EPROM chip	p.o.a.	n/a
Econoram 2708, 16K EPROM (NØ EPROMS)	£45	£65
Econoram 2716, 16K EPROM (NØ EPROMS), 8K RAM (NØ RAMS)	£55	£75
Econoram IIa, 8K	£80	£99
Interfacor 2 full RS232 serial I/O	£99	£125
Econoram IV, 16K, 1 x 16K	£150	£169
Econoram VIIa, 16K, 1 x 8K + 2 x 4K	£165	£185
Econoram VIIa, 24K, 2 x 8K + 2 x 4K	£230	£249
Econoram XIIIa, 32K, bank select, 2 x 16K	£315	£339

EXTRA LOW PRICES ON QUALITY DISKS

Brand name diskettes stocked for most micros.
Pack of ten 5 1/4 in. disks, £19. Ten packs (100 disks), £175.
Pack of ten 8 in. disks, £23. Ten packs (100 disks), £210.
When ordering please specify whether you require hard or soft-sectored diskettes, and if hard-sectored, the number of sectors.

Anadex DP8000 Printer. Ready to go! Includes RS232 cable, 1,000 sheets continuous stationery and Securicor delivery within UK. Only £525.

All prices given include postage and packing (overseas add £10). Just add VAT. Send 10p stamp for details. Quantity discounts available on application. Credit terms (nett 30 days) given to large companies and Government establishments.

Mail Order 'phone: 01-828 1785 LTT ELECTRONICS
8 Waldegrave Road
London SE19

DISKS : LTT : MEMORY : DISKS : LTT : MEMORY : DISKS :

• Circle No. 122

Graham Knott & Jeff Orr have now moved....

to new premises due to expansion to accommodate larger stock and workshop facilities for the Microcomputer user. Our new number is

051-933 5511

ring us at any time for your requirements



PET	
Pet 8k	£550
Pet 16k	£675
Pet 32k	£795
2nd Cassette	£55

Disk Units	
Computhink 400k Random and Sequential complete to fit 8k Pet (via expandamem)	£840
To fit 16/32n Pet (direct fitting)	£895
800k Unit	£1144

Memory Expansion

24k Expandamem for Pet	£320
------------------------	------

Interfaces

Uni-direc I-EEE to RS232	£89
Bi-direc I-EEE to RS232	£140
Bi-direc 2 ported I-EEE to RS232	£175

A/D Convertors

AIM 161 16 channel A/D converter for Apple, Aim, Nascom etc	£130
Petset 1, AIM 161 including all interfacing requirements for Pet, complete	£166

Stack Peripherals

Stack Joystick a balanced, calibrated unit supplied with software and examples of use, complete	£25
New 625 Video Adaptor a vastly improved 625 video converter for Pet, works extremely well	£25
Stack Page Printer Interface copies screen contents onto 20m.a. loop complete with software	£25

APPLE	
Apple-plus (b&w) 16k	£770
ITT 2020 (colour) 16k	£830
16k RAM upgrade	£85
Printer Card	£110
Communication Card	£132
High Speed Serial Card	£110
Disk Drive with DOS	£398
Extra Disk Drive	£355
Diskettes (10's)	£30
KIM 1	£99.95
MANUALS New Pet user manual	£5
6500 Programming manual	£5
6500 Hardware manual	£5

PRINTERS

Teletype 43 pinfeed RS232 friction RS232	£860
pin and friction RS232	£875
Anadex DP8000	£889
Decwriter IV LA34	£575
Perkins Elmer Pussycat CRT Copier	£880
Also Centronics Range, Texas Instruments, Lear Siegler	£839
Ring us for a quote on individual models.	

Consumables

Anadex DP8000 paper (2000 sheets) 9.5" x 11" drop	£15
Teletype 43 pinfeed paper (2000 sheets) 12" x 11" drop	£15
8.5 inch friction roll Box'A' quality (12" x 3.5" diam. rolls)	£20

Box 'B' quality (12 x 3.5" diam rolls)	£15
Box 'A' quality (6 x 5" diam rolls)	£20
Box 'B' quality (6 x 5" diam rolls)	£15

Cassettes

C15 cassettes high quality tape, 5 screw cassette cases, per 10	£4.40
---	-------

Disks & Diskettes

We supply 8" and 5.25" diskettes for all disk drives. Please state your machine and we can give you a quotation.
e.g. Pet 2040 £30 per 10
Computhink £30 per 10
Apple £30 per 10
Horizon £30 per 10
Sorcerer £30 per 10
Many others in stock, both hard and soft sectored.

Connectors

Pet User Port/I-EEE Port	£1.10 each
Pet 2nd cassette Port	85p each
Hoods for User/I-EEE connectors	£2.25
D.25 RS232 Connectors (State male or female)	£3.00
D.25 Hoods	£2.25

Demagnetiser

Curved head	£4.00
If any requirements are not listed please ring us as we may have them in stock.	

All prices are +VAT at 15% and include carriage (unless otherwise stated). Please make cheques payable to Stack Computer Services Ltd.

Stack Computer Services Ltd

290-298 Derby Rd, Bootle

Liverpool 20

The Rohan Computing Collection.....

Rohan computing, in addition to their normal software and systems consultancy services, now offer the following range of computer equipment for sale. As far as possible Rohan computing try to hold these items in stock ready for immediate delivery. Nationwide on site maintenance for all Rohan computing equipment.

Qume The Qume is ideal as a general purpose printer or for adding word processing facilities to an existing micro-computer. Print only and keyboard versions available. The keyboard version can double as a spare typewriter. RS232 interface adaptable for the PET, APPLE, etc. XON/XOFF protocol available. Word processing package/driver available for CP/M based systems. Other versions in preparation.

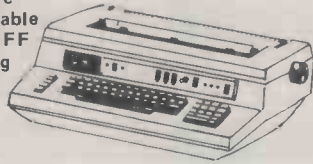

Digital Decwriter IV. The best desk top matrix printing terminal available. Typewriter styling. 10,12,13,2,16,5 characters per inch. All sizes very legible. 2,3,4,6,8,12 lines per inch. Optional tractor feed and numeric keypad. RS 232 interface.

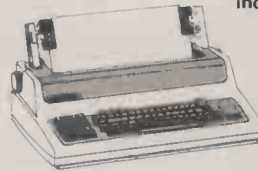

PET Commodore PET microcomputers. The PET is the ideal low cost computer for teaching yourself programming, educational use and time consuming calculations in science, industry and commerce. Graphic display excellent for histograms etc.
 *8k PET with integral cassette and minikeyboard
 *16 & 32k PET's with full sized professional keyboards.
 *2022 matrix printers
 *2040 floppy disc units.



CIFER Cifer 2600 Series VDU's. Superbly engineered and made in Britain. *12 inch screen.
 *7 x 11 character matrix
 *9 x 12 matrix for graphic characters
 *62 or 100 key detachable keyboards
 *Printer port
 *VT52 emulation
 *Line drawing set

RAIR Blackbox, Teletype 43s, Tally high speed matrix printers also available.

Rohan

Phone Richard on SOUTHAM (092681) 3541 for prices and delivery.

Rohan Computing, B.A.S.S. (Engineers) Sales Limited, Kinton Road, Southam, Warwickshire CV33 0DD

• Circle No. 124

SYSTEMATICS INTERNATIONAL LIMITED

Specialists for microcomputer systems and software development for business invite enquiries from PROFESSIONAL DEALERS who wish to sell in specific territories in the U.K.

ITT 2020 microcomputer systems and/or
 MICROSTAR 45 multi-tasking, multi-user microcomputer systems.

A full range of business/financial/accounting software is available, together with a comprehensive software development/technical/promotional support service.

Applications should be made to Ronald Young, Managing Director.

Telephone Basildon 284601, or write to:

Essex House
 Cherrydown
 Basildon
 Essex

Telex 99431 S ig

• Circle No. 125

XITAN SYSTEMS

CROMEMCO SYSTEM 3

£4,054.00 for this system with vdu.

The ideal business system. System includes a full 64K fast RAM, dual full-size floppies (Persci 277), RS232 interface/20mamp loop for console device, parallel printer port (Centronics/Anadex compatible), 21 slots for expansion, Lear Siesler 24 lines or 80 chars vdu, and ... CROMEMCO's CDOS operating system with their 14 digit BCD extended disk Basic — ideal for those accurate large numbers required by successful businesses. CDOS is CP/M functionally equivalent, with many extra facilities. Optional extras from Xitan include Fortran, Cobol, Text Formatting, Z-80 macro-relocating assembler and DBMS at £59.00 each, CIS interactive screen handling Cobol at £425.00 (recommended to serious business users), Cromemco S100 boards, CP/M (we are an authorised oem distributor of Digital Research's CP/M) for the System 3, Wordmaster, Wordstar, Supersort, and CPM374X utilities.



COMING SOON! ... Full 7-terminal multi-user operating system from Cromemco for System 3 users. Up to 48K per user, all running independently. This operating system has to be seen to be believed. It will run any of the Cromemco provided and supported software packages, in any combination. Features include partition rescue facilities, allocating more memory to users, real-time clock for time/date stamping of jobs and disk queueing techniques. Buy your System 3 now, expand later as you need it.

S100 BRITISH COLOUR BOARD

We are proud to offer the first BRITISH S100 Colour board. Manufactured by a local Southampton company — Hi-tech, we can thoroughly recommend this product. Features include true PAL colour generation for high-definition on your television or colour monitor, 15+ colours and black/white with 6 additional grey scales, 24 lines with 40 characters per line, with standard character set plus 44 numbers and symbols, and 64 computer selected graphics symbols. Symbols include fractions and the £ symbol. Plotting is available at 80 x 72 resolution. Single or double-height characters, with flashing on an on/off duty cycle of 3-1. The board is memory mapped on any 2K boundary, with its I/O port set at any of the 256 available on the S100 bus. Just plug into your S100 system and colour television and go! Driver software and documentation provided. Price £295.00 ex vat cash with order. Please specify if for television or 75 ohm monitor.



ON DEMO NOW! THE CROMEMCO Z2-H

For only £4,995.00 set the reliability and quality of Cromemco, coupled with the capacity of the new IMI 11 megabyte hard disk drive. This is incredible value for money. Specification includes transfer rates of up to 10 times faster than the fastest standard floppy disk, DMA controller for up to 7 hard disk units, and the new extended CDOS operating system. Systems available in three configurations: — A) The Z2-H complete integral system, 64K RAM, Z80A cpu, two double-sided mini-floppies, RS232 console port, parallel printer port, power supplies, cables, case and 12-slot S100 motherboard (7 slots free). B) Additional hard disk subsystem for existing system 2 or system 3 users consisting of one hard disk, DMA controller, power supply, case and cable. C) As unit B but with two hard disks. Prices: Unit A) £5,380.00.
B) £4,330.00.
C) £7,420.00.

Xitan Systems also supplies and stocks vdus, printers, NORTH STAR HORIZON computers, Commodore Business Machines PETs, S100 boards, and books. We are here to demonstrate the range of quality microcomputer systems available for use today. Ring up for an appointment now! You'll not be disappointed. We have Osborne's Sales Ledger and Payable Ledger in source form for use on Cromemco System 3 with CBASIC2, and we can offer a customising service on these programs. Additional software includes Microsoft Basic Interpreter and Compilers, Cbasic, Macro80, and CP/M for the North Star Horizon.

Xitan Systems Ltd., 23 Cumberland Place, Southampton SO1 2BB.

Tel: (0703) 38740

Hours Tue-Sat 9.30 am to 5.30 pm

• Circle No. 126

NOW from MUTEK ... THE OSI SPECIALIST

THE CHALLENGER 1P

Standard Features

- Uses the ultra powerful 6502 microprocessor
- 8K Microsoft BASIC-in-ROM.
Full feature BASIC runs faster than currently available personal computers and all 8080-based business computers.
- 4K static RAM on board expandable to 8K
- Full 53-key keyboard with upper/lower case and user programmability
- Kansas City standard audio cassette interface for high reliability.
- Full machine code monitor and I/O utilities in ROM.
- Direct access video display has 1K of dedicated memory (besides 4K user memory), features upper case, lower case, graphics and gaming characters for an effective screen resolution of up to 256 by 256 points. Normal TV's with overscan display about 24 rows of 24 characters; without overscan up to 30 x 30 characters.

Extras

- Available expander board features 24K static RAM (additional), dual mini-floppy interface, port adapter for printer and modem and an OSI 48 line expansion interface.
- Assembler/editor and extended machine code monitor available.

Fully packaged with power supply. Just plug into a normal T.V. and mains to be up and running.

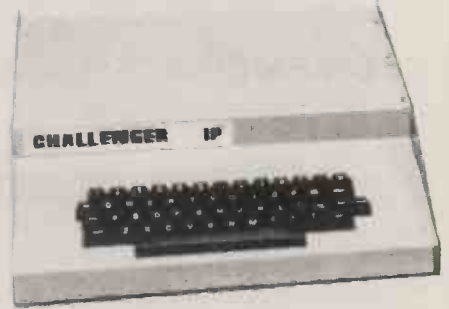

£220
+ VAT

A wide variety of superboard CI & CII software is now available from us, send now for our catalogue.

We are still, of course, offering the popular C2-4P at the most competitive price of £349 + VAT.

***FOR THE LARGER USER . . .** The OSI C3-OEM 32K RAM, dual floppy discs, add on 23MB or 74MB hard discs, multi-user multi-programming. Software includes a host of Business applications packages; General Ledger, Stock Control etc. Also CP/M FORTRAN and COBOL, *in fact almost anything written for the 6800, Z-80, 8080 or 6502.*

Please contact us to see how your tasks can be handled . . . for less than you expect.

***WE OFFER AN UNPARALLELED SERVICE AND REPAIR FACILITY,** from repair in our own workshops, to a countrywide yearly maintenance service by one of the largest groups in the U.K.

Please send SAE for your personal inquiries.

MUTEK QUARRY HILL, BOX, WILTS. (0225) 743289

• Circle No. 127

V&T ELECTRONIC

EPROMS — All Ex Stock

2532	5V	4K x 8	48.00
2516	only	2K x 8	Intel Compat Now 15.40
2708		1K x 8	6.00

RAMS

4116	16K Dynamic	200 ns	6.50
4116	16K Dynamic	300 ns	6.25
2114	1K x 4 Static	200 ns	Low Power 5.50
2114	1K x 4 Static	450 ns	4.25
TRIS	80 16K Upgrade Kits		52.00

NASCOM 2

16K Ram	295
16K Ram	Built 325
32K Ram	345
32K Ram	Built 375

ALL ITEMS EX-STOCK

Please Add 15% VAT

40p P&P orders under £10.00

V&T ASSEMBLER

New improved V&T Assembler now available for Nascom 1 & 2.

The only fully relocatable assembler for the Nascom range — (easily converted to other Z80 systems).

— Supports all standard mnemonics & pseudo ops: — DEFB, DEFS, DEFW, DEFM, EQU & ORG. Source, object & symbol areas fully programmable.

Now includes —

- Symbol table
- Operation under T2, T4, B Bug, Nasys
- Label find & change
- Relocating source reader
- Improved keyboard routine, etc.

£12.50 + VAT

Existing V&T Assembler owners may return orig. tape to obtain updated version.

S.A.E. + £2.50 Inc VAT

V&T Superdeck — CPU Controlled £110.00

Please see previous Nov. Ad for full details

Exidy Sorcerer 16K — £670 + VAT — includes basic Rom.

V&T ELECTRONICS 82 CHESTER RD., LONDON N.19 5BZ
01-263 2643

• Circle No. 128

EUROPE'S LARGEST SELECTION OF MICROCOMPUTER BOOKS, MAGAZINES AND SOFTWARE FOR THE HOBBYIST, EDUCATIONALIST, PROFESSIONAL AND RETAILER.

BOOKS

SUMMER HOLIDAY BONUS: for the purchase of 3 books or more, and paying by cheque, P.O. or cash, give yourself a 10% DISCOUNT!

Introduction to Microcomputers: by Osborne	
Vol 0: Beginners Book	£5.95
Vol 1: Basic Concepts	£6.30
Vol 2: Some Real Microprocessors (without binder)	£18.95
Vol 2: Some Real Microprocessors (with binder)	£24.70
Vol 3: Some Real Support Devices (without binder)	£11.95
Vol 3: Some Real Support Devices (with binder)	£17.70
Updating subscription (6 issues) for Vol 2	£18.95
Updating subscription (6 issues) for Vol 3	£18.95
Updating subscriptions for Vol 2 & 3	£30.00
1 Updating issue (specify for Vol 2 or 3)	£4.00
1 Binder (specify for Vol 2 or 3)	£5.75

Microprocessors from Chips to Systems	£7.00
Microprocessor Interfacing Techniques	£8.75
Z80 Microcomputer Handbook	£7.50
TV Typewriter Cookbook	£7.50
Cheap Video Cookbook	£4.30
CMOS Cookbook	£7.50
IC OF AMP Cookbook	£8.95
RTL Cookbook	£4.25
TTL Cookbook	£7.50
IC Timer Cookbook	£7.50
Circuits Circuit Cellar	£5.50
First Book of KIM	£7.00

6800 Programming for Logic Design	£6.30
8080 Programming for Logic Design	£6.30
Z80 Programming for Logic Design	£6.30

Introduction to Personal and Business Computing	£4.95
Getting Involved with your Own Computer	£4.75
Buyer's Guide to Microsoftware	£2.40
How to Profit from Your Personal Computer	£5.50
Microcomputer Potpourri	£1.75
Hobby Computers are Here	£3.95
New Hobby Computers	£3.95
Understanding Microcomputers and Small Computer Systems	£6.95

More BASIC Computer Games (coming soon)	£5.50
BASIC Computer Games (also see software section)	£5.00
What To Do After Your Hit Return	£8.95
8080 Galaxy Game	£6.95
SUPER-WUMPUS A game in 6800 Assembler code & BASIC	£4.25
Computer Music	£6.75
Computer Rage (A Board Game)	£6.95
Artist and Computer	£3.95
Games with a Pocket Calculator	£1.75
Games, Tricks & Puzzles for a Hand Calculator	£2.49
Introduction to TRS 80 graphics	£5.75
Take My Computer Please... (light hearted fiction)	£3.25

Instant BASIC	£6.95
Basic BASIC	£6.50
Advanced BASIC	£6.00
My Computer Likes Me... When I Speak in BASIC	£2.75
Calculating with BASIC	£4.95
Users Guide to North Star BASIC	£10.00
Introduction to PASCAL	£3.95

Z80 Instruction Handbook	£2.95
8080 Programmers Pocket Guide	£1.95
8080 Hex Code Card	£1.95
8080 Octal Code Card	£1.95

Accounts Payable and Accounts Receivable	£10.95
Payroll with Cost Accounting	£10.95
General Ledger	£10.95

Best of BYTE	£8.95
Scelbi BYTE Primer	£8.95
Best of Creative Computing Vol 1	£6.95
Best of Creative Computing Vol 2	£6.95
Best of MICRO (Issues 1-6 of Micro Magazine)	£5.50

Basic Software Library:	
Vol 1: Business and Games Programs	£17.50
Vol 2: Maths, Engineering and Statistical Programs	£17.50
Vol 3: Advanced Business Programs	£26.95
Vol 4: General Purpose Programs	£7.95
Vol 5: Experimenters Programs	£7.95
Vol 6: Miniature Business System	£32.50
Vol 7: Chess/Medbil/Wdproc Programs	£26.95

Z80 Assembly Language Programming (coming soon)	£6.45
6502 Assembly Language Programming (coming soon)	£6.45
Microcomputer Programming 6502	£7.95
6502 Applications Book (coming soon)	£7.95
8080A 8085 Assembly Language Programming	£6.45
6800 Assembly Language Programming	£6.45
8080 Software Gourmet Guide and Cookbook	£6.95
6800 Software Gourmet Guide and Cookbook	£6.95
8080 8085 Software Design	£6.75
6800 Tracer An aid to 6800 Programme Debugging	£3.95
Program Design	£4.25
Programming Techniques: Simulation	£4.25

Some Common BASIC Programs	£6.30
Computer Programs that Work (in BASIC)	£2.55
32 BASIC Programs for the PET	£10.10

PIMS A Database Management System	£5.95
Scelbi High Level Language - Supplements	£15.00
Basex A Simple Language - Compiler for the 8080	£5.50

8080 Standard Monitor	£9.95
8080 Standard Editor	£9.95
8080 Standard Assembler	£9.95
Special Package: 8080 Assembler, Editor, Monitor	£20.00
Bar Code Loader for 6800, 8080, Z80 and 6502	£1.75
Tiny Assembler for 6800 Systems	£5.75
RA 6800 ML An M600 Relocatable Macro Assembler	£15.95
LINK 68 An M6800 Linking Loader	£5.50
MONDEB An advanced M6800 Monitor Debugger	£3.50

MAGAZINES

SUMMER HOLIDAY BONUS: For the purchase of 3 Magazines or more, and paying by cheque, P.O. or cash, give yourself a 10% DISCOUNT!

Magazine Subscriptions:	UK Price	Overseas Price
Subscriptions start within 3 weeks		
MICRO (6502, 8080/85) (12 issues)	£12.50	£12.50
Personal Computing (12 issues)	£17.00	£17.00
Interface Age (12 issues)	£25.00	£25.00
Dr Dobbs Journal (10 issues)	£13.50	£13.50
Computer Music Journal (4 issues)	£11.00	£11.00
People's Computers (6 issues)	£8.50	£8.50
BYTE (12 issues)	£24.50	£24.50
Creative Computing (12 issues)	£16.50	£16.50
Kilobaud (12 issues)	£21.00	£21.00

Magazine Back Issues:	
Micro-6502 Journal	£1.50
Personal Computing	£1.95
Interface Age	£2.95
ROM	£1.95
Dr Dobbs Journal	£1.95
Computer Music Journal	£3.75
People's Computers	£1.95
BYTE	£2.95
Creative Computing	£1.95
Calculators and Computers	£1.95
Kilobaud (reprints only)	P.O.A.
73	£2.25
Magazine Storage Box (Holds 12)	£1.25

HOW TO ORDER

Please note our book magazine prices include postage and packing, but not insurance, if wanted add 12p for every £10 of books ordered. Make cheques, PO's etc. payable to: — L.P. Enterprises.

CREDIT CARDS accepted
BARCLAYCARD VISA/ACCESS/DINERS CLUB/
AMERICAN EXPRESS
Phone: 01-553 1001 for Credit Card orders (24 hr answering service)

All publications are published in U.S.A. and shipped into Britain air-freight by L.P. Enterprises. In unusual cases, processing may exceed 30 days.

Prices subject to change without notice

TRADE ENQUIRIES WELCOME

THIS LIST CANCELS ALL PREVIOUS PRICE LISTS: EFFECTIVE JULY 1979
DUE TO FLUCTUATIONS OF THE DOLLAR. PRICES SUBJECT TO CHANGE WITHOUT NOTICE.

Send to address on page	All Orders must be Prepaid:
Indicate Payment Method; and underline items required.	Total Enclosed £
..... My cheque, P.O., I.M.O. is enclosed in Sterling on U.K. Bank	Charge to Barclaycard / Visa / Access / Diners / American Express
Credit Card No.	Expiry Date
Name	
Address	
.....	POSTCODE
Signature	

Microcomputers are coming - ride the wave! Learn to program.

Millions of jobs are threatened but millions more will be created. Learn BASIC- the language of the small computer and the most easy-to-learn computer language in widespread use. Teach yourself with a course which takes you from complete ignorance step-by-step to real proficiency with a unique style of graded hints. In 60 straightforward lessons you will learn the five essentials of programming: problem definition, flowcharting, coding the program, debugging, clear documentation.

Book 1 Computers and what they do well; READ, DATA, PRINT, powers, brackets, variable names; LET; errors; coding simple programs.

Book 2 High and low level languages; flowcharting; functions; REM and documentation; INPUT, IF...THEN, GO TO; limitations of computers, problem definition.

Book 3 Compilers and interpreters; loops, FOR...NEXT, RESTORE; debugging; arrays; bubble sorting; TAB.

Book 4 Advanced BASIC; subroutines; string variables; files; complex programming; examples; glossary.

Understand Digital Electronics

Written for the student or enthusiast, this course is packed with information, diagrams and questions designed to lead you step-by-step through number systems and Boolean algebra to memories, counters and simple arithmetic circuits and finally to an understanding of the design and operation of calculators and computers.

Book 1 Octal, hexadecimal and binary number systems; conversion between number systems; representation of negative numbers; complementary systems.

Book 2 OR and AND functions; logic gates; NOT, exclusive-OR, NAND, NOR and exclusive-NOR functions; multiple input gates; truth tables; De Morgans Laws; canonical forms; logic conventions; karnaugh mapping; three state and wired logic.

Book 3 Half adders and full adders; subtractors; serial and parallel adders; processors and ALU's; multiplication and division systems.

Book 4 Flip flops; shift registers; asynchronous and synchronous counters; ring, Johnson and exclusive-OR feedback counters; ROMS and RAMS.

Book 5 Structure of calculators; keyboard encoding; decoding display data; register systems; control unit; program ROM; address decoding.

Book 6 CPU; memory organisation; character representation; program storage; address modes, input/output systems; program interrupts; interrupt priorities; programming, assemblers; computers; executive programs; operating systems.

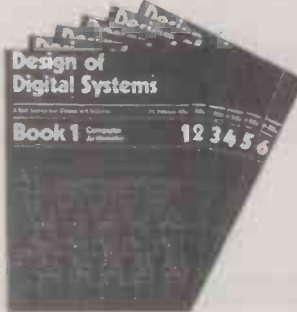

GUARANTEE - No risk to you

If you are not completely satisfied your money will be refunded on return of the books in good condition.

Please send me:-

.... **Computer Programming in BASIC (4 books) @ £7.50**

.... **Design of Digital Systems (6 books) @ £11.50**

All prices include worldwide surface mailing costs (airmail extra)

IF YOUR ORDER EXCEEDS £15, DEDUCT £2

I enclose a cheque/PO payable to Cambridge Learning Enterprises for £.....

or please charge my Access/Barclaycard account no.....

Telephone orders from credit card holders accepted on 0480-67446 (Ansafone). Overseas customers (inc Eire) send a bank draft in sterling drawn on a London bank, or quote credit card and number.

Name

Address

Cambridge Learning Enterprises, Unit 43, Rivermill Site, FREEPOST, St. Ives, Huntingdon, Cambs PE17 4BR England.

• Circle No. 130

*The new all-British-designed single-board
MICROCOMPUTER*

**SEMEL-ABACUS
IN KIT FORM**

- * Supplied with 16K of RAM
- * Uses the powerful Z-80 Microprocessor
- * Space for up to 32K RAM on board
- * 8K Full Basic
- * VDU Memory Mapped
- * 64 Characters by 16 Lines
- * Tape Interface
- * Single-Board Construction
- * RS232 Printer Interface
- * Plugs into a standard TV set
- * Full alphanumeric Characters plus 64 User-Definable Graphics
- * Stabilised power supply

OPTIONAL

- * Colour Graphics
- * Expansion board to full 64K Memory
- * Analogue Interface

STRUTT

ELECTRICAL AND MECHANICAL ENGINEERING LTD.
3c Barley Market St., Tavistock, Devon PL19 05F
Tel: Tavistock (0822) 5439 Telex: 45263

• Circle No. 131

AERCO GEMSOFT

APPLE 2 Comes to Woking!

Aerco Gemsoft have just opened their new computer division in Woking and invite you to drop in for a look at some real computers:-

APPLE 2

SUPERBRAIN

MICROSTAR 45

OHIO SCIENTIFIC

We are official Apple agents and southern area distributors for the Intertec Superbrain:

Apple 2 16K (Europlus B & W)	£750.00
Superbrain 64K (Twin Disks)	£1995.00
ITT 2020 16K (Colour)	£867.00
Microstar 45 Plus	£4950.00
Apple 2 Disk Units from	£355.00
16K Memory Upgrade Kit	£69.00
Serial/Parallel Interface Card	£110.00
Pascal Language Card	£296.00
Anadex DP-8000 Printer	£570.00
9" Hitachi Monitor	£132.00
12" Hitachi Monitor	£210.00
Auto-Start ROM	£40.00
Eurocolour Card	£69.00

DISK BASED BUSINESS SOFTWARE FOR APPLE 2/ITT 2020

- Sales Ledger Payroll
- Stock Control General Ledger
- Invoice Printer Price List Maintenance
- Please add 15% VAT to above prices.

Send S.A.E. for full catalogue containing over 100 programs for PET, Apple & Exidy Sorcerer. Trade enquiries welcome.

Gemsoft can supply you with a complete (and fully expandable!) Apple system off the shelf including twin disks & printer for £2431 + VAT.

We specialise in designing complete systems and our expert in-house programmers are available to write any customised software from business systems, through industrial control systems to scientific and research programs.

GEMSOFT LTD, 27 Chobham Road, Woking, Surrey. Phone Woking (04862) 22881.
Open 6 days a week 9.30-5.30 p.m.

• Circle No. 132

NEWCASTLE UPON TYNE'S OWN MICROCOMPUTER SYSTEMS HOUSE

MULLER (ANGLO AMERICAN COMPUTERS) LTD*

- **CONSULTING: Microcomputer Systems Analysis & Feasibility Studies**
NATIONWIDE MAPCON Registered Consultancy: See Below
£2000 FREE CONSULTING! Why do Without the Facts?
- **SYSTEMS DEVELOPMENT: Integrated Hardware & Software Systems**
TURNKEY Systems: Fully Customised Programming
Professional Design, Development, & Maintenance
Start-to-Finish Systems Integration
Low-Cost Standard Business Software
Specialists in Low-Cost Computerisations
Give us the TOUGH Jobs: That Increase Business & Profits
 - Automated Estimation & Tendering
 - Process Control & Production Management
 - Distributed Processing (Multiprocessing)
 - Management Information
 - Retail Point-of-Sale & Inventory System
- **EXPERIENCED DEALER: Industry Standard Hardware & Operating Systems**
Featuring the SDS-200 Maximum Capacity Business System
As Advertised in This and Previous Issues of PC
By AIRAMCO the UK Distributor

£2000 FREE CONSULTING

- **VIA Non-Returnable 100% Government Grant for First £2000**
(This is Enough in 95% of all Cases)
- **AVAILABLE TO Qualified Industries & Manufacturers Small or Large**
- **Most Firms are Fully Served by Flexible Microcomputer Systems**
Why Settle for Expensive Limited-Function Accounting Machines
(For £8,000 - £12,000)?
Why Pay for a Minicomputer-Mainframe at £15 - 50,000 ?
- **TODAY'S Technology at a Fraction of the Cost:**
Typically Only £5,000 - £15,000!
- **THE Government Department of Industry Wants You to Have the Facts**
By Way of a MAPCON Registered Consultant
Non-Believers are Invited to Ring for the Attention of Mr. Nish
MAPCON Dept. of Industry at Stevenage (0438) 3388
- **AVAILABLE from the NATIONWIDE MAPCON Consultancy Above**

*E Floor, Milburn House, Dean Street Newcastle upon Tyne (0632) 29593

Great new Crofton double!

Self contained
**MONITOR
PCB**



- Compact size, 5" x 7"
- Complete with power and video plugs, plus leads
- Scan coil assembly as standard supplied
- Transformers, tubes, and surrounds available
- 15v Mains or 12v DC power
- Ideal for O.E.M. use

ONLY **£35.50** ONLY **£85.00**

EX VAT AND P&P

Crofton Electronics

Crofton Electronics Limited, 35 Grosvenor Road,
Twickenham, Middlesex. Tel.: 01 891 923



self contained 10"
MONITOR

- Totally enclosed
- All transisterised
- Suitable for analogue signals or alphanumerics
- Operable on 220v Mains or 12v DC power
- Comparable to wire frame monitors

• Circle No. 133

BITS & P.C.s

COMPUTER PRODUCTS

NOW A NASCOM DISTRIBUTOR IN YORKSHIRE

Full range of Nascom Products available.
We are Nascom service and repair specialists order with confidence.
Free for a limited period with Nascom 2. 16K memory board, mini mother board and 2 edge connectors. This is 8K more memory than specified and leaves 28K of free space.
Unbelievable Nascom 1 now only £125.00 or £140.00 ready built and tested.

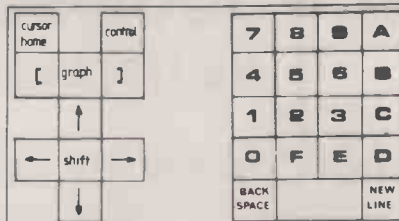

Upgrade your Nascom 1 to Nascom 2.

By using our specially designed control key pad this enables you to run Nas-sys on Nascom 1. Gain on screen edit and cursor movement. The power of Nas-sys. Kit only £21.50. Nas-sys £25.00.

A hexadecimally keypad for Nascom 1 & 2. Specially designed for your Nascom by us. This is an essential for entry of machine code listings. New line, space and back space are duplicated for convenience. £29.50 complete kit.

Control and hexadecimally key pads combined for Nascom 1 £36.50 complete kit. The above key pads require no modification at all to your Nascom.

Port Probe. A simple but essential device for Nascom 1 or 2. Allows monitoring of the port output on L.E.D. Indicators, input words can be set up with L.E.D. indication interrupts can be tested manually or by using the variable clock provided, this also allows real timing for games £10.60 complete kit.

Dual monitor board. This kit allows switching between 2 monitors on Nascom 1 £5.40.

Chess for Nascom. A powerful chess programme which requires our graphics options. This must be the best chess graphics available. £15.00 on cassette, ask for details.

Nascom 1	£125.00 kit or built	£145.00
Nascom 2		£295.00
Power Supply Unit		£29.50
Nascom 1 Buffer Board		£32.50
8K Ram Board		£85.00
16K Ram Board		£140.00
32K Ram Board		£200.00
Nascom 1 Graphics	p.o.a.	
Nascom 2 Graphics Rom		£15.00
Bits & P.C.s Data Cassettes		
Price for 10 C12		£4.75

Please check with us for your Nascom requirements.
Add 15% VAT to all our prices.
Barclaycard and Access phone your order. Personal demonstrations by appointment. Please send S.A.E. for any details.
BITS & P.C.s
18 Rye Garth
Wetherby, West Yorkshire
LS 22 4UL
Tel: (0937) 63744 9 a.m. to 7 p.m.

• Circle No. 134



NewBear Books



★SEND FOR COMPLETE LIST.★

GAMES

Chess & Computer	D. Levy	£ 7.16
Chess Skill in Man and Machine	P. Frey	£11.84
32 Basic Programs for the Pet		£ 8.90
Game Playing with Computers	D. Spencer	£10.20
Basic Computer Games	D. Ahl	£ 5.50
Star Ship Simulation		£ 5.10
Game Playing with Basic	D. Spencer	£ 4.10
Sargon	Spracklen	£ 9.50

MISCELLANEOUS

Intro. to TRS 80 Graphics		£ 5.75
Microprocessors C201	Zaks	£ 7.50
Scelbi Byte Primer		£ 9.95
Business Data Systems	Clinton	£ 5.75
The Systems Analyst	Atwood	£ 6.60
Your Home Computer	White	£ 4.95
Programming a Micro 6502	Foster	£ 7.95
6502 Applications Handbook	Zaks	£ 8.95

BASIC

Learning Basic Fast	De Rossi	£ 6.30
Basic Basic	J. S. Coan	£ 5.00
Advanced Basic	J. S. Coan	£ 5.50
Illustrated Basic	D. Alcock	£ 2.25
Basic with Business Applications	Hayden	£ 8.40
Basic Primer	Waite	£ 5.80
The Basic Handbook	Lien	£11.00

COBOL

Cobol Programming	Nickerson	£ 6.95
Learning Cobol Fast	De Rossi	£ 6.20
Cobol with Style	Hayden	£ 4.20
Reducing Cobol Complexity	Mc Clue	£11.30

PASCAL

Pascal: User Manual and Report	Springer-Verlag	£ 5.52
Problem Solving Using Pascal	Springer-Verlag	£ 7.84
Programming in Pascal	P. Grogono	£ 7.50
A Practical Intro. to Pascal	A. Addyman	£ 3.50
An Introduction to Programming and Problem Solving with Pascal	Schneider	£ 9.50
Introduction to Pascal	J. Welsh & J. Elder	£ 6.95

Z80 BOOKS

Z80 Programming for Logic Design	A. Osbourne	£ 5.95
Z80 Technical Manual	Zilog	£ 4.00
Z80 P10 Technical Manual	Zilog	£ 3.25
Z80 Programming Manual	Zilog	£ 4.50
Z80 Microcomputer Handbook	W. Barden	£ 6.95
Practical Microcomputer Programming (Z80)	Weller	£19.55
Z80 Instruction Handbook	Scelbi	£ 3.25
Z80 Assembly Language Programming	A. Osbourne	£ 6.95
Introduction to TRS 80 Graphics	Inman	£ 5.75
Zilog Data Book	Zilog	£ 3.50
Z8001/Z8002 Product Specification	Zilog	£ 3.75
Z8000 CPU Instruction Set	Zilog	£11.50
Z80 Micro Programming & Interfacing	Nichols	£ 7.10

NEW BOOKS

COBOL for Beginners	Worth	£ 7.75
BASIC for Everyone	Worth	£ 7.50
MICROS for Business Applications	Barden	£ 5.80
Fortran 77	Katzan	£13.75

★ CREDIT SALES (Minimum £10), Access and Barclaycard Welcome. "BY RETURN ORDER SERVICE" ★

CALLERS AND MAIL ORDER: 40 Bartholomew Street, Newbury, Berks. Tel: 0635 30505
CALLERS ONLY: 220-222 Stockport Road, Cheadle Heath, Stockport Tel: 061 491 2290

• Circle No. 135



CAUSE FOR CELEBRATION

At the Wembley Conference Centre.
22nd to 24th July 1980

This exhibition, international conference and six seminars adds up to the most significant microcomputer event ever held in the U.K.

Join the top names in the business and book your space now at advantageous rates.

And remember, some exhibitors will have an additional cause for celebration: Exhibitors at the Mersey Micro Show and the 1980 Microcomputer Show are eligible to 10% discount on both events!

The 1979 Microcomputer Show



What the Exhibitors said

"Still suffering from shell-shock. We are now getting over 100 enquiries a week" **Tony Winter, Joint Managing Director, Grama (Winter) Ltd.**

"Best micro show so far. Visitors were enthusiastically spending money and placing orders" **Kerr Borland, Managing Director, Nascom**

"An outstandingly successful show" **Mike Sterland, Managing Director, Personal Computers Ltd.**

What the Papers said

"Micro mania hits London - staggering success - the sort of frenzy usually seen at January sales" **Datalink.**

"Show's switch to small business systems was a great success" **Computer Weekly.**

"Online scores a treble-record crowds" **Electronics Weekly.**

online

Just return this coupon or call
Jane McBarnet at
Online Conferences Ltd,
Cleveland Road, Uxbridge,
Middlesex UB8 2DD.
Telephone: 0895 39262.

Please send 1980 Microcomputer Show Exhibition details.
 Please send Mersey/Micro Show Exhibition details.
Name _____
Address _____
Tel No _____

PC2

• Circle No. 136



Buy
with confidence
from the specialists
HB COMPUTERS LTD

Stock a full range
Under One Roof

**BUSINESS AND GAMES SOFTWARE
FOR THE CBM PET**

**DISC BASED BUSINESS SOFTWARE
CBM 3040 AND COMPU/THINK**

SALES LEDGER

Process up to 1,000 accounts. Full input audit trail,
enquiries, statements, debtors list and sales analysis.
.....£350

PURCHASE LEDGER

Specifications as per Sales Ledger.£350

ESTATE AGENT

Property file maintained and houses selected.
.....£25.00

WORD PROCESSOR

All the usual word processor features plus global
changes and right justify.£50.00

MAIL LIST

Names, addresses and selection codes on disc. Will
interface with our word processor.£50.00

CASSETTE BASED SOFTWARE

STOCK WATCHER

Up to 250 stock items processed. Stock Reports,
re-order, etc.£25.00

R H SHAPEMATCH

Memory game. Children love this one.£5.00

R H MASTERMIND

Our version of this popular brain teaser.£8.00

SNAKES & LADDERS

You choose the number of snakes and ladders.
Good graphics. Works with our SOUNDBOX ...

R H MICROPOLY

Monopoly board controlled by your PET. Nobody
is lumbered with the bank.£12.00

HB COMPUTERS LTD

22 NEWLAND STREET, KETTERING
NORTHANTS.

Tel. (0536) 83922 & 520910 Telex 341297

All prices exclude VAT.

• Circle No. 137

BIRMINGHAM COMPUTER CENTRE

Commodore
Authorised agents
PESOFT DIST.
PETACT
business
programs



Specialists in
Commodore
Hardware
ALL MODELS
EX STOCK

2001-4K 2001-8K 2001-16K 2001-32K

All at special discount prices including large keyboard

Floppy dual disk drive — Printers

KIMI BETSI — KIMSI, etc

Cassette tapes super quality

Diskettes — super quality

Our range of products now extended to include: New Euro
Apple II with auto-start and Applesoft in ROM (save RAM)
new low price from £750.

Exidy Sorcerer plug-in ROM cartridge S100 expansion Z-80
CPU word from 760 16K.

Midland stockists of Grama Winter Software.

Camden BD 80 Printer professional business use. 2K
character buffer Now available ex stock £595 —

Send for free literature

HP terms available

Showrooms open Mon to Sat, 10am-6pm
Camden Electronics (first floor) 462 Coventry Road,
Small Heath, Birmingham B10 0UG Tel: (021) 7738240

• Circle No. 138

Erase Eproms in 8 minutes for under £100



£97 delivered in U.K.
+ V.A.T.

The high speed, high capacity model UV8 sets new
performance and price standards.

- Cuts typical erasure times by a factor of 5
- 8 MINUTE SOLID STATE TIMER
- Capacity up to 14 EPROMS
- 2708 type erased in 4 to 7 minutes
- High intensity 254 NM UV source
- Safety interlock automatically starts timing sequence
- Audio tone signals erasure cycle complete
- Internal switch to extend erase time.

MICRODATA Computers Ltd, Belvedere Works, Bilton
Way, Pump Lane Industrial Estate, Hayes, Middlesex.

Telephone (01) 848 9871 (6 lines) Telex 934110

• Circle No. 139

Sintrom Microshop

The S100 computer centre

Sintrom Periflex microcomputer with both
5" and 8" floppy disc drives

Vector Graphic microcomputers

Micropolis 5" floppy disc drives (now in stock)

Micropolis 8" Winchester / S100 systems

Telema computer systems

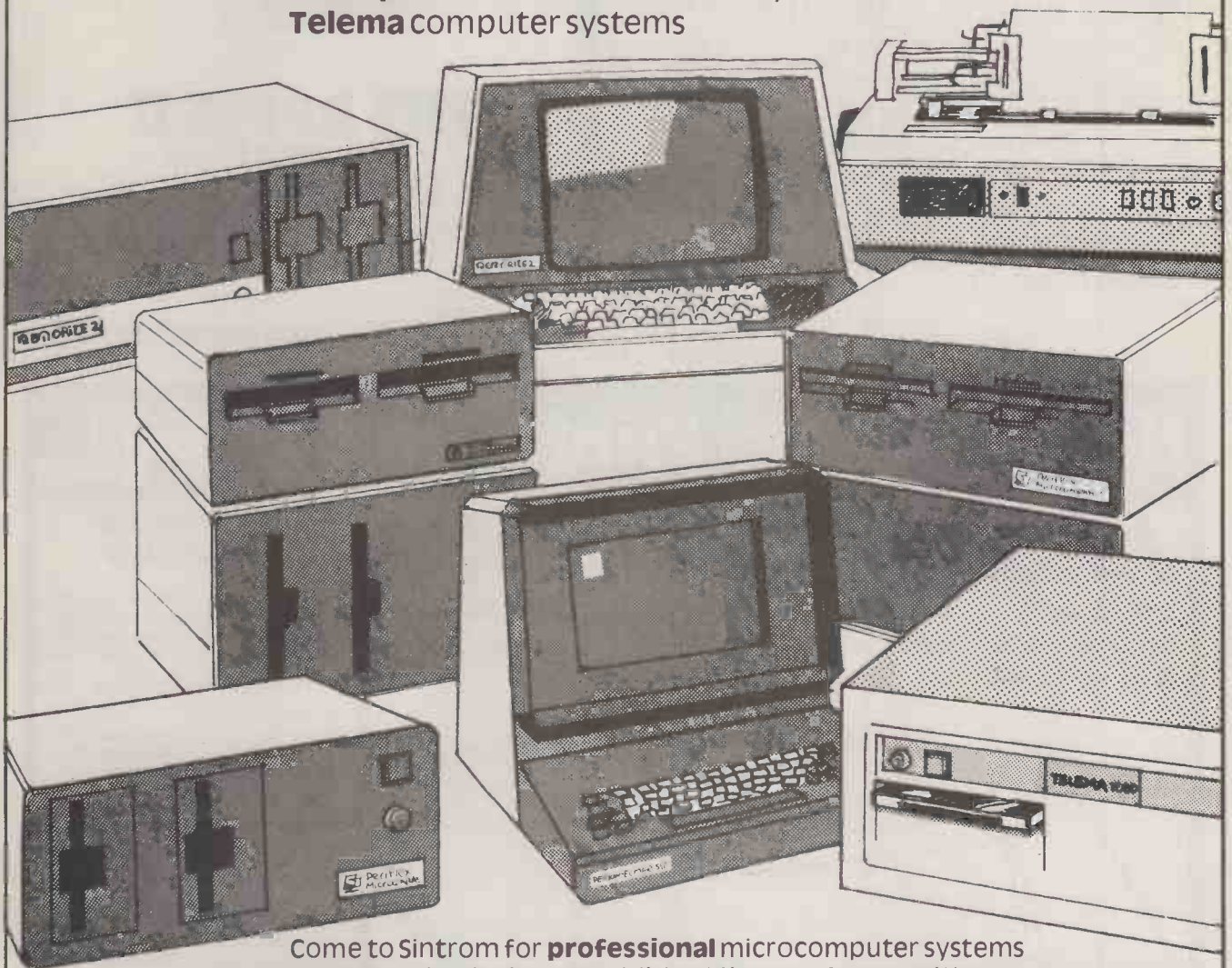

Come to Sintrom for **professional** microcomputer systems backed-up by the long established Sintrom Group, with years of experience in mini and micro computer systems and peripherals.



SINTROM MICROSHOP

14 Arkwright Road, Reading, Berks RG2 0LS

Tel: Reading (0734) 85464 TELEX: 847395

Sintrom Microshop is a division of the Sintrom Group of Companies

• Circle No. 140

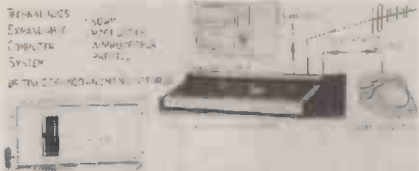

TECS: FEATURES

- * VIEWDATA AND PRESTEL DATABASE ACCESS
- * FULLY EXPANDABLE COMPUTER SYSTEM
- * MEMORY-MAPPED TV DISPLAY RAM
- * 24ROW x 40 CHARACTER, ALPHANUMERIC AND GRAPHICS (224 Individual symbols) DISPLAYED IN SIX COLOURS PLUS B&W, ON UNMODIFIED COLOUR T.V.
- * EXPANSION TO FULL 64K MEMORY
- * SUPPORTS BOTH 5¼" and 8" FLOPPY DISCS
- * RS232 PORT AS STANDARD
- * 3K TECS MINI-BASIC, INTEGER VERSION WITH COLOUR DISPLAY
- * 8K TECS BASIC; FULL FLOATING POINT VERSION
- * TECSBUG: POWERFUL MACHINE CODE MONITOR
- * TECSOFT RANGE OF SOFTWARE TO EXPLOIT THE FULL POTENTIAL OF THE TECS SYSTEM
- * FULL FACILITY TELETEXT RECEPTION (CEEFAX, ORACLE)
- * KANSAS CITY STANDARD CASSETTE INTERFACE
- * FULL DOCUMENTATION PACK
- * ALL SYSTEMS CAN BE EXPANDED LATER;

SYSTEM T1 TELETEXT, 3K BASIC KIT	BUILT
4K USER RAM	£895
SYSTEM T2 TELETEXT, MONITOR, 8K BASIC, 4K USER RAM	£1175
	1405
SYSTEM T2a AS T2 but +16K RAM	£1335
SYSTEM T2b AS T2 but +32K	£1435
SYSTEM T2c AS T2 but +48K	£1535
SYSTEM T4 'PRESTEL SYSTEM' TELETEXT, PRESTEL, 4K RAM, 3K BASIC	N/A
	£1955

(KITS AVAILABLE DIRECT FROM TECHNOLOGICS ONLY.) PLEASE SEND FOR FURTHER DETAILS (LARGE S.A.E., 13P STAMP PLEASE) OR ORDER NOW (SPECIFY RACK OR TABLETOP VERSION) FROM YOUR DEALER OR IN CASE OF DIFFICULTY DIRECT FROM TECS SALES DEPT.,

TECHNOLOGICS LTD.,
8 EGERTON STREET, LIVERPOOL L8 7LY Tel: 051-724 2695

ALL ORDERS DEALT WITH IN STRICT ROTATION, CARRIAGE AND INSURANCE PAID. ALL PRICES SUBJECT TO 15% VAT.

• Circle No. 141

THIS IS AN APPLE



AND THIS IS AN APPLE TWO



THE APPLE II IS AVAILABLE FROM MICROLOGIC

Temple House, 43-48 New Street, Birmingham

021-643 0253

(off Needless Alley, Reception 3rd Floor)

• Circle No. 142

New Low-cost Printer from PHL

Anadex DP 8000

- 80 Columns
- 112 cps - 84 lpm bi-directional
- 1K Print Buffer
- Dual Interface - Serial & Parallel
- 96 ASCII set, 9 x 7 matrix

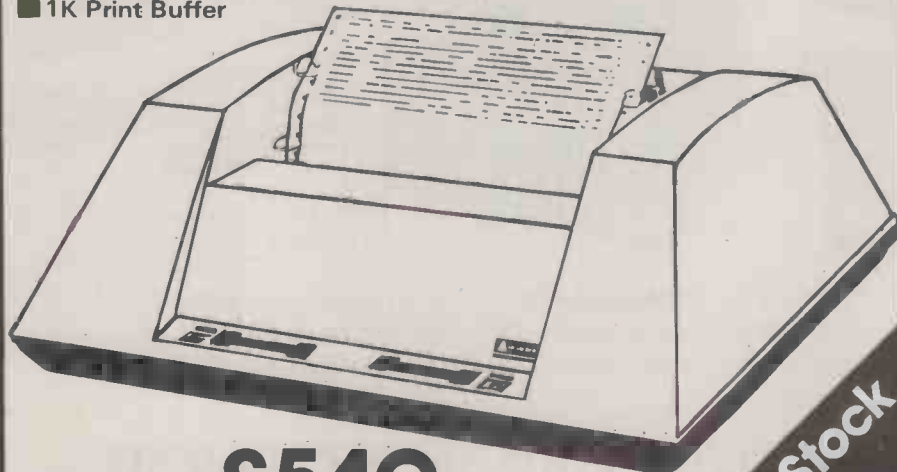

From Only **£540**

EX Stock

Also available Visual Displays

- Lear Siegler
- ADM - 3A from only £571
- ADM - 3A Graphics from only £1295
- ADM - 31 from only £795
- ADM - 42 from only £1049

Keyboard Printers

- Teletype 43
- Pin Feed from only £ 799
- Friction Feed from only £ 818
- Typewriter Terminal from only £ 825
- Portable Models from only £ 899
- Digital
- LA 36 from only £995
- LA 34 from only £895
- LA 120 from only £1655

Printers

- Texas 810 from only £1392
- SCI Rotary Printer from only £ 747

Data Storage

- Techtran
- 950 Microdisc Range from only £ 955
- 815 Daticassettes from only £ 667

Other Items

- AJ 211 Acoustic Coupler from only £ 199



PERIPHERAL HARDWARE LIMITED
Armfield Close, West Molesey
Surrey England Telex 922175
Sole UK distributor

South 01-941 4806 North Harrogate 501263/4 Ireland Dublin 952316

• Circle No. 143

TVI-912 the INTELLIGENT V.D.U.

£595

(1 off End User)

**Attractive Quantity
and OEM discount
available on
request.**

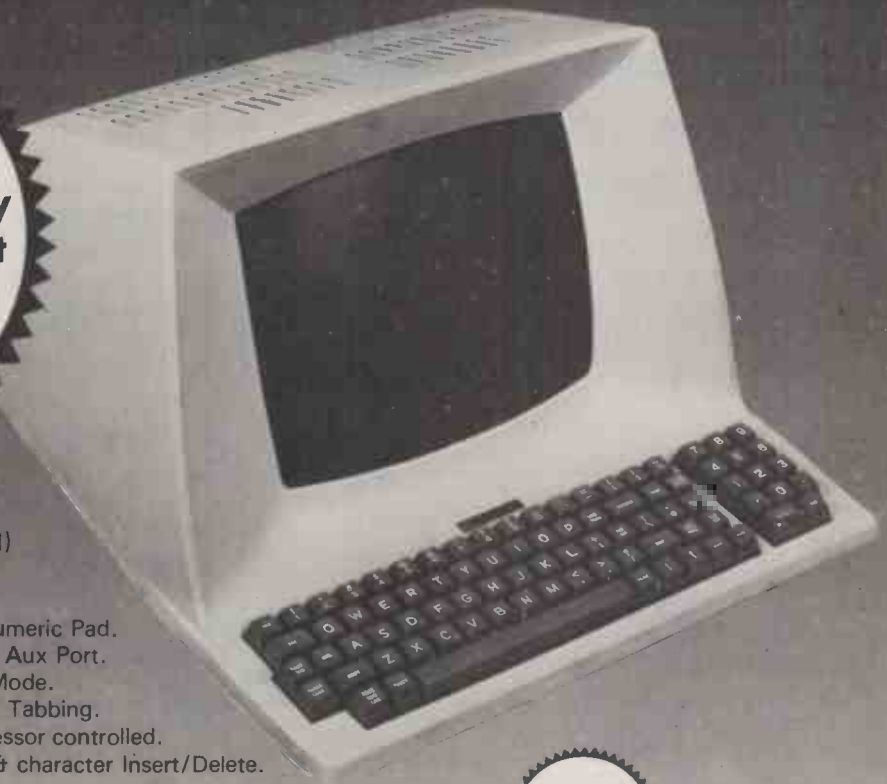

TVI-912 V.D.U. (illustrated)

- 15 Baud rates, 75 to 19,000 Baud.
- Dual Intensity. ● 24 x 80 char.
- 12 x 10 character resolution. ● Numeric Pad.
- Programmable reversible video. ● Aux Port.
- 80 storable tabbing. ● Self Test Mode.
- Protect Mode. ● Block Mode. ● Tabbing.
- Addressable cursor. ● Microprocessor controlled.
- Programmable underline. ● Line & character Insert/Delete.

£650

TVI-912/52 V.D.U.

Incorporates all the features of the TVI-912, but has VT52 emulation fitted as standard.

THE LOWEST PRICED UNIT OF ITS TYPE ON THE U.K. MARKET.

£695

TVI-920 V.D.U.

Incorporates functions of standard model TVI-912, but has extra row of function and editing keys, 2nd page memory and printer port.

Midlectron market a wide range of Computer Terminals, Microcomputer Modules and can provide small Computer Systems configured to specific requirements.

Large stocks are held of Terminals and Computer Modules to provide IMMEDIATE delivery on standard items and fast delivery on Systems.

Our Manufacturing Division designs and produces a number of peripherals specially designed to meet the needs of the market. All products are fully supported by our experienced team of Hardware and Software Specialists.

Midlectron Ltd

Computer Systems + Terminals

King Street, Belper, Derby DE5 1PW

Telephone: Belper (0773 82) 5442/5780 Telex: 377879
South East Regional Office. Telephone 01-550 3834

Unleash your Pet* to its full capability.



Two ways to 32K. Add on or add in.

One way: Petite memory system.

- Self-contained peripheral for any Commodore Pet.
- Plugs into mains and Pet.
- No modifications required.
- No demands on Pet power supply.
- No extra heat dissipation within Pet cabinet.
- No warranty problems.

The Other: Inpet memory board.

- Mounts onto Pet processor board.
- Built in PSU.
- Simple to fit.
- Complete with all connectors.
- Low cost version.

* Trademark of Commodore Business Systems

One way or the other you get a reliable memory from Plessey Microsystems, Europe's leading memory manufacturer. Either way you get a memory to make your Pet more like a powerful business computer. Available from authorised distributors of Plessey Pet peripherals. Send for full information and the address of your nearest distributor.



**PLESSEY
MICROSYSTEMS**

Plessey Microsystems Limited, Water Lane, Towcester, Northants NN12 7JN
Telephone: Towcester (0327) 50312 Telex: 31628

• Circle No. 145

BE ONE OF THE FIRST TO OWN The New Sharp MZ80-K

Sharp dealers for N.W. Kent.
Demonstrations given, at your premises, in that area.
Other demonstrations by arrangement.

PET HIRE

From £5 per day or £25 per week.

Authorised PETSOF/ PETACT dealers.
10% discount on all Petsoft/ Petact products.
Please add 50p p. & p. to your order.
Send large SAE for Petsoft catalogues.

*All prices subject to VAT.
Send Cheque/P.O. with orders to:*

ESSEX COMPUTER SERVICES
10 Grafton Road, Canvey Island,
Essex, SS8 7BT.
Tel. Canvey Island (03743) 61663



• Circle No. 146

M I C R O C O N T R O L



— THE INTERFACE EXPERTS

224 EDGWARE ROAD
LONDON W2
Tel 01-402 8842

MICRO CONTROL have been building specialised hardware and writing software, since Apple first came into the country. We can interface your Apple to *anything* with a custom designed card for a reasonable price. We can also provide Business Systems for Apple II and Micro Star to your requirements.

Centronics Printer Card	£132.00	Micro Hush Printer & Apple Interface	£266.00
Apple disk drive	£355.00	Thermal paperroll for Micro Hush	£2.00
— with controller card	£398.00	9in b/w monitor	£117.50
4-Channel A/D cards 12-bit	£174.00	Printers, VDU's, ITT, Apples, Software & one-off's P.O.A.	
8-bit	£127.00		
4-Channel D/A 8-bit	£110.00	Apple Pascal	£296.00
Com. Card	£132.00	Microstar	£4,950.00
High Speed Serial Card	£110.00	Apple II 16K	£750.00
Integer Firmware Card		16K add In 150ns	£58.00
(inc. Mini-Assembler)	£110.00	Micro Products Eprom Burner	£140.00
Apple Voice recognition Card	£165.00	Box of 10 diskettes	£30.00

R.G.B. colour card! Superb resolution and quality from your Apple. Multi-coloured text, background colour and Access from program £150.00

Complete colour system for Apple with R.G.B. monitor £414.00

Phone for quote on ultra fast 8 bit A/D. Real Time Clock and specialised interfaces. Also 4-Channel D/A 12 bit. 4-Channel Mains Dimmer £175.00

• Circle No. 147

TMZ80 from TERODEC



The TMZ-80 range of microcomputer systems provide cost effective and reliable solutions to your business problems with unrivalled flexibility

- Choice of operating system — CPM1.4, CPM2.0, or OASIS
- Interfaces to most VDU's, Line, Dotmatrix, Daisy Wheel Printers and Modems
- 64K Bytes of RAM as standard — expandable to 256K Bytes (for multiuser environment)
- Single or Multiprocessor
- 1-4 m Bytes Floppy Disc storage
- Hard, Fixed or Cartridge Disc expansion
- Custom Software service
- Single or Multiuser
- Software Hot Line
- Reliable
- Nationwide maintenance
- 4 MHz Z-80 CPU
- Staff Training
- Installation and Commissioning
- Attractively styled work station
- Comprehensive standard software available
- BASIC, CBASIC-2, FORTRAN, ANSI 74 COBOL and PASCAL
- Full range of VDUs and Printers

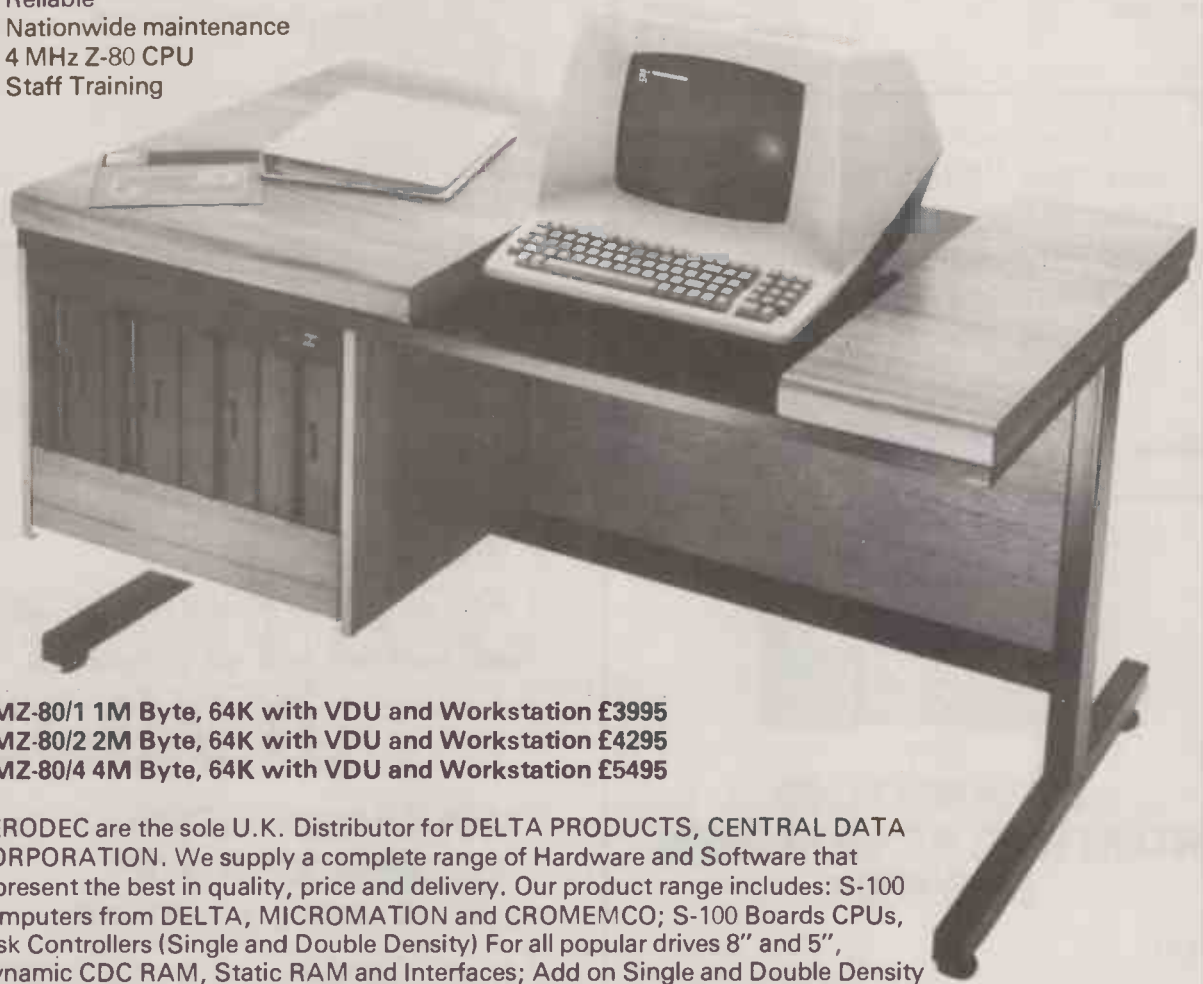

TMZ-80/1 1M Byte, 64K with VDU and Workstation £3995
TMZ-80/2 2M Byte, 64K with VDU and Workstation £4295
TMZ-80/4 4M Byte, 64K with VDU and Workstation £5495

TERODEC are the sole U.K. Distributor for DELTA PRODUCTS, CENTRAL DATA CORPORATION. We supply a complete range of Hardware and Software that represent the best in quality, price and delivery. Our product range includes: S-100 computers from DELTA, MICROMATION and CROMEMCO; S-100 Boards CPUs, Disk Controllers (Single and Double Density) For all popular drives 8" and 5", Dynamic CDC RAM, Static RAM and Interfaces; Add on Single and Double Density Disk Drives for TRS-80, Exidy Sorcerer and all S-100 Computers; Printers from DECISION DATA and PRINTERM; VDUs from TVI, SOROC and PERICOM; A comprehensive range of applications software, Accountancy, Stock Control, Word Processing and more; Compilers; Interpreters; Assemblers. When other products do not measure up call any TERODEC Showroom or Dealer for fast response.

MICROBITS
34B London Rd., Blackwater,
Camberley, Surrey
Tel: (0276) 34044

TERODEC SYSTEMS LTD
16/17 College Place,
Southampton, Hants.
Tel: (0703) 39511/5

OEM and Dealer Enquiries Invited

TERODEC
(MICROSYSTEMS) Limited
43 Qualitas, Roman Hill
Bracknell, Berkshire
RG12 4QG
0344-51160



• Circle No. 148



apples by post

Apple 16K	£725	<input type="checkbox"/>
Disk with controller	£375	<input type="checkbox"/>
Disk drive only	£325	<input type="checkbox"/>
16K add on memory	£65	<input type="checkbox"/>
Please send brochure		<input type="checkbox"/>

Prices exclusive of VAT

Other information available on request

Name

Address

Please enclose cheque and send to
Business Computer Services
 Pollards Farmhouse, Clanville,
 Nr. Andover, Hampshire.
 Telephone 0264 70 300

Allow 10 days for delivery
 All systems delivered by SECURICOR
 to Mainland U.K. — carriage free

 **apple® computer inc.**

• Circle No. 149

MICROTEK COMPUTER SERVICES

FOR:
EQUINOX 300
NORTH STAR HORIZON
IMS 5000

PLUS:

DIABLO, ELBIT & TEXAS PERIPHERALS.
 SOFTWARE PACKAGES FOR:

- STOCK CONTROL
- ACCOUNTING AND VAT
- CLIENT INFORMATION & MAILING
- BUDGET CONTROL
- CAR STOCK BOOK
- IMPORT CONTROL
- PAYROLL
- 'LOCATE-A-CAR' SYSTEM, ETC.

**50, Chislehurst Road, Orpington,
 Kent.**
Tel: Orpington 26803

• Circle No. 151

Some Christmas Gift Ideas

ENTERPRISE — 3 games, Speedway, Brain Drain, and Black Jack plus a four-function memory calculator	£24.95
CHESSMATE — by Commodore 8-level chess computer, 32 book openings plays black or white, built-in clock	£69.95 our price £59.95
MASTERMIND — electronic version of this famous game, play against the computer, 3, 4 or 5 digit code	£15.90 our price £12.90
CHROMA-CHIME — the ultimate in door chimes, select any one of 24 tunes. Available as a kit	£10.50 or ready-made £15.90
STAR CHESS — space age chess game played on your own TV, in colour and with sound effects, plus p.s.u.	£69.16 our price £63.35
VOICE CHALLENGER — the first chess computer to speak. 10 levels. The most powerful program to date. Comes complete with pieces, attache case and power supply	£249.95
DATA BASE — one of the latest programmable TV games, in colour. Cartridges include Horse Racing; Boxing; Black Jack	£89.95
MONKEY SEE — MONKEY DO — can you follow the code? Similar to Simon, great fun for Christmas	£19.95
CREDIT CARD CALCULATOR — by Commodore, the ideal calculator to carry around. Over 1000 hours battery life	£8.95
SPACE ALERT — by Mattel, hand-held with sound also available Auto Race and Soccer	Soccer £21.50 others £16.90
MARKSMAN — electronic shooting game. Comes with an Owl target and pistol. Shoot the owl dead centre, eyes flash and it makes a chirping sound. Sells for £9.90. Our price only	£5.90
CHESS CHAMPION — economical 6-level chess computer. Comes with power supply at a new low price of only	£54.95
COMPUTE-A-TUNE — micro-controlled mini organ, the memory will remember 32 notes and replay at correct speed. With effects	£21.20
HOW TO BUILD A COMPUTER-CONTROLLED ROBOT — very good book	£5.90

Exidy Sorcerer from £747.50. Expansion box 6-slot £241.50
 Micropolis Dual Disc Drive — £1,380; Centronics 779 — £920; Pet 2001 from — £529;
 Dual Disc Drive — £851.
 APPLE II (b&w) 16K RAM £954.50. Disc drive & controller £488.75.
 5 1/4 in. disks £4.90 ea. 8 in. disks £5.90 ea.
 Plastic Print Wheels IBM etc. £5.95
 NASCOM 1 kit £189.75 or Built & Tested £247.25
 NASCOM 2 kit £339.25 or Built & Tested £396.75
 Ohio SUPERBOARD II 8K Basic, 4K RAM Built & Tested £263.35
 COMPUKIT UK101 8K Basic, 4K RAM + Power Supply Built & Tested £303.00
 TRS 80 Level II 16K RAM, Computer only £460.00
 16K Memory expansion kits (APPLY — SORCERER — TRS 80) only £69.00
 3A Power Supply kit £23.00 or Built & Tested £28.75
 TRS 80 Library 100 — 100 Programs on Cassettes £46.95
 2K BASIC for NASCOM 1 used in place of Nasbug or B-Bug £22.90
 Large range of computer etc. books. Send for List
 SAE with all enquiries — All prices inclusive

SUPPLIERS TO BUSINESS, EDUCATION & HEALTH AUTHORITIES



N.I.C.

27 Sidney Road, London N22 4LT
 01-889 9736

the software house

APPLE II MICROCOMPUTERS
 BUSINESS SOFTWARE
 EDUCATIONAL SOFTWARE

DEMONSTRATIONS GLADLY GIVEN
 WE CARE ABOUT AFTER SALES
 SERVICE & ADVICE IS FREELY
 AVAILABLE ON MOST SUBJECTS

SHOWROOM:
 146 OXFORD STREET LONDON W.1.
 TEL. 01-637-1587

OUR CATALOGUE OF SOFTWARE
 (FOR MOST MICROS) IS FREE

• Circle No. 152

Listen, Westrex have more to offer than you realise.

Yes more new models. A bigger sales and service team.
And plenty of new ideas. Give us a ring now and let's talk.

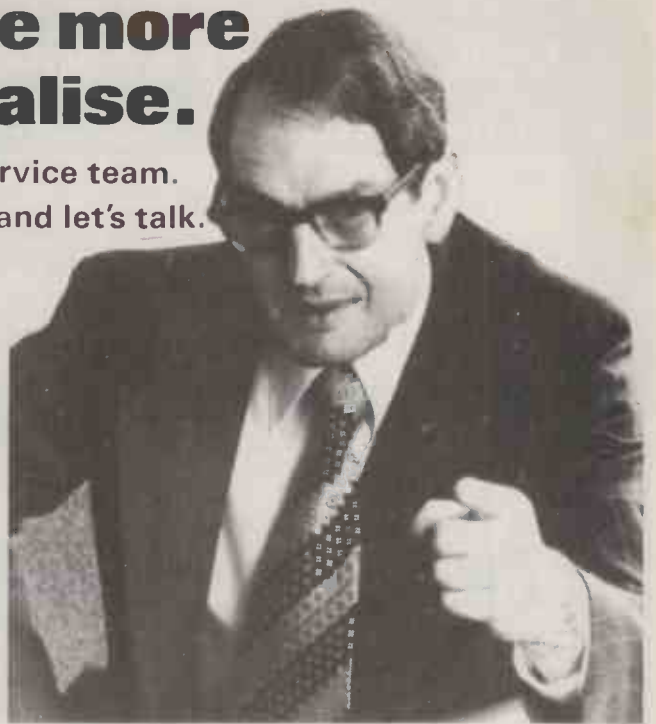

Fred Allen Managing Director Westrex Company



TALLY 1600 series micro controlled KSR
160 C.P.S. matrix printers.



TELETYPE MODEL 43 10/30 C.P.S.
Keyboard send/receive terminal.



TELETYPE MODEL 43 Automatic send/receive
terminal with paper tape reader and punch.

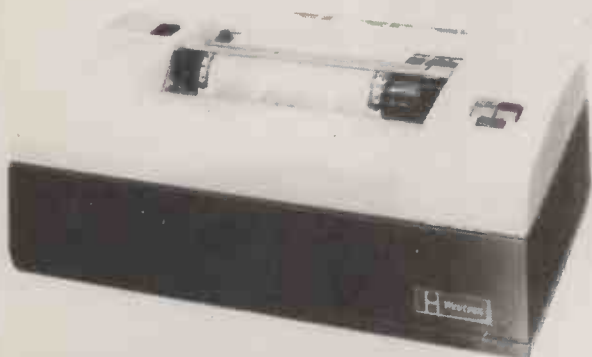

MANNESMANN MODEL 80 series receive
only matrix printers.



PERKIN ELMER 550 BANTAM.
Teletype compatible Visual Display unit.



Westrex Company Limited, 152 Coles Green Road, London NW2 7HE. Tel: 01-452 5401
and at Manchester Telephone: 061-764 0324 and Glasgow Telephone: 041-332 2052/3

• Circle No. 153

U. K. — Micro Supplies — SCOTLAND 03374-795

FLOPPY DISCS MICROPOLIS

1041-11 315K drive + controller
Cable + BASIC, ASSEMBLER,
+ EDITOR only £595.00
1015-11 315K drive — add-on £395.00
other products on application
DS525-10 Pack of 10 5¼in. floppy disk £29.00

S100 BOARDS

SD Sales 32K Ram 375 ns Assm. +tested £355
JADE Z80 2 mhz Assm. +tested £140
MIKOS 15 slot Mother Board Assm. +tested £110
MIKOS 2 Parallel/2 Serial Assm. +tested £130
MIKOS 16K Erom (No 2708's) Assm. +tested £110
MIKOS Extender Board Assm. +tested £47
MIKOS Real time clock 2 interrupt Assm. +tested £120
DSEL P.S.U. Kit +8v ±16v 4A Assm. +tested £175

V. D. U.s LEAR SIEGLER

ADM 3A Introductory Offer £550.00
Hard disks 5-36 M6 POA
Volume discounts *special offer*

SOFTWARE

CP/M for Micropolis £90
MACRO for above £60
TAILORED Software for all applications

PRINTERS CENTRONICS

Centronics 779 £750.00
Centronics 701 £1210.00
Centronics 703 £1894.00

SYSTEMS

U.K. DISTRIBUTOR for
SDS-200 (SD Sales) also HORIZON,
CROMEMCO, DATA SYSTEM 800, 801

FULL SERVICE & BACK-UP FACILITIES AVAILABLE

Telephone for all Non-Listed items
OEM & DISCOUNTS on Application

ACCESS BARCLAYCARD
Delivery at cost — Prices exclude VAT

DATA SYSTEMS SUPPLIES LTD.

SHORE HEAD ROAD, INDUSTRIAL ESTATE,
NEWBURGH, FIFE, SCOTLAND.

03374-795

• Circle No. 154

SIRTON PRODUCTS (SP)

13 WARWICK ROAD
COULSDON
SURREY Tel: 01-660 5617



MIDAS S100 SYSTEMS

Substantial Mainframe to house your S100 system, with optional 5in. or 8in. disc drives. Special systems built to your requirements from Z-80 CPU and other S100 boards held in stock.

Mainframes from £228

MIDAS 1 : Z-80 System from £625 (built)

MIDAS 2 : Z-80 5in. Disc System from £1,100 (built).

MIDAS 3 : Z-80 8in. Disc System from £1,300 (built).

ITHACA INTERSYSTEMS DPS 1

Professional versatile computer system with comprehensive front-panel facilities and 20-slot motherboard. Units have substantial power supply etc. and come with 2 or 4 MHz Z-80 CPU. BUS conforms to the IEEE S100 standard.

DPS.1 from £695



COMPREHENSIVE RANGE OF S100 BOARDS AND SOFTWARE STOCKED

from

ITHACA INTERSYSTEMS · S D SYSTEMS · GODBOUT · CROMEMCO ·
ECT · S S M · Etc

Write or Phone for Catalogue



• Circle No. 155

HERE'S TREMENDOUS VALUE FROM COMPUTER CENTRE

MINI KIT

The lowest priced CP/M Z80 Micro in U.K. Add your power and terminal. Minifloppy 16KB, RAM, Z80, CTC, Serial + Parallel I/O, S100 motherboard, connectors, manuals CP/M system FREE BASIC and ALGOL. Optional two drive case illustrated and power supply £149



£786

MEGABYTE

MEGABYTE MICRO KIT
CP/M disc based micro in kit form! Just add power and a terminal. Kit includes:
Drive, 8in double sided double density, Z80, CTC, Serial and Parallel I/O, 16K ram (expandable to 64K), CP/M systems, connectors, manuals. Case and power supply extra £149. Assembled and Dual Drive versions available.



ONLY AVAILABLE from us at this SPECIAL PRICE
£998

MINI FLOPPY

Double/single density hard or soft sector used for TRS80 North Star etc.



£189

8 INCH DRIVE

DRI 7100 (Shugart Compatible) single/dual density. British Made. Assembled + Guaranteed. Double sided version. £375

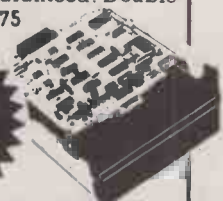

£299

S100 KITS



8K Static Ram Kit
4MHz has run in Northstar, Cromenco, etc. £79 ass. £94

64K Dynamic Ram Kit
4MHz runs with 8080, Z80, uses 16kbit chips £449 ass. £499

SBC 100 Single board Z80
S100, Z80, CTC, USART 1K RAM, 4 ROM, Serial and Parallel I/O. £155 ass. £215

Eprom Programmer Kit
for 2708, or 2716 Eproms S100, Eprom sockets £99 ass. £145

Also S100	kit	ass.
16K Econoram IV 4MHz	175	199
8080A with vector interrupt	69	104
IO4 2 Serial/Parallel	89	124
Tarbell disc controller	125	160
Versafloppy disc controller	99	140
VDB 80x24 Video	185	245
Motherboard (11 slot)	19	—
Prototype board	18	—

SDS 100

Z80, 12" VDU, 1M. Byte, twin drives, Serial + Parallel outputs, numeric pad, CP/M system



£3650

TRS 80

16K bytes upgrade kits - these are the IC's that even work in the 48 k expansion. Excellent instructions, screw driver and common sense extra!



£69

CP/M SOFTWARE

CP/M Operating system + 6 manuals + Basic - E £64
Extensive User group £4.50
Library includes Basic 8" DISC compilers/interpreters Algol-60, Pilot, Stoic, utilities and games. 10 copies £35

Proprietary software:
Microsoft Basic £180
Fortran £280
CIS Cobol £380
UCSD
Pascal £150

All advertised items generally in stock. Cash with order ensures same day despatch. Add 2% postage and 15% VAT to advertised prices.
Send: Catalogue (please tick)

Send:

I enclose cheque for £

Name

Address

COMPUTER CENTRE

THE DISCOUNT COMPUTER STORE

9 De la Beche Street, Swansea, SA1 3EX. Tel: 0792 460023 Telex: 48638

Computer Selector?

Throw away the pin! Let Cambridge Computer Store help you choose the right system from one of the biggest selections of microcomputers and peripherals in the country — most of which you can see on demonstration and buy off the shelf:

TANDY • TRS 80 • APPLE • PET • N-S HORIZON
CROMEMCO • COMPUKIT • ACORN • INFOTON
LEAR-SIEGLER • CENTRONICS • ANADIX

Back-up this impressive range with truly professional standards of advice and after-sales support and you can take the guesswork out of computer selection.

Cambridge Computer Store

1 Emmanuel Street, Cambridge CB1 1NE
Telephone (0223) 68155

• Circle No. 157

New low book prices

Also dealers for Acorn, Apple, Microstar and Alpha Micro.

BASIC & BASIC PROGRAMS

Running Wild: The Next Industrial Revolution Adam Osborne	£ 3.50
The Mighty Micro Chris Evans	£ 5.50
X1 Microprocessor Lexicon Sybex Inc.	£ 2.50
Microelectronics Scientific American	£ 4.00
Mind Appliance T G Lewis	£ 4.80
Introduction to Microcomputers Vol 0 — The Beginner's Book Adam Osborne	£ 5.40
Introduction to Microcomputers Volume 1 — Basic Concepts Adam Osborne	£ 5.90
Your Home Computer James White	£ 5.90
Peanut Butter & Jelly Guide to Computers Jerry Willis	£ 6.30
C201 Microprocessors: from Chips to Systems Rodnay Zaks	£ 6.90
Illustrating BASIC Donald Alcock	£ 2.30
Microcomputers in the Three R's: A Teacher's Guide Christine Doerr	£ 4.90
Little Book of BASIC Style: How to write a program you can read John Nevison	£ 5.40
Programming in BASIC for Business Bosworth/Nagel	£ 6.90
Basic Handbook David Lien	£11.00
BASIC and the Personal Computer Dwyer/Critchfield	£11.90
Computer Programs that Work! Lee/Beech/Lee	£ 3.00
Basic Computer Games David Ahl (Ed)	£ 5.50
More Computer Games David Ahl (Ed)	£ 5.50
Some Common BASIC Programs Poole/Borchers	£ 6.50
6502/6800/8080/Z80	
8080A/8085 Assembly Language Programming Lance Leventhal	£ 6.30
Z80 Assembly Language Programming Lance Leventhal	£ 6.90
Z80 Microcomputer Handbook William Barden	£ 6.90
Sargon: A Computer Chess Program Dan & Kathe Spracklen	£ 9.50



CompUtopia LIMITED

30 Lake Street, Leighton Buzzard, Bedfordshire
Tel: (0525) 376600 24 hour Answering Service

6800 Assembly Language Programming Lance Leventhal	£ 6.30
6502 Assembly Language Programming Lance Leventhal	£ 6.90
C202 Programming the 6502 Rodnay Zaks	£ 6.90
First Book of KIM Butterfield et al	£ 7.00
D302 6502 Applications Book Rodnay Zaks	£ 7.90
Programming a Microcomputer: 6502 Microprogram- ming MOS' KIM-1 Caxton C Foster	£ 7.90
Practical Introduction to Pascal Wilson/Addyman	£ 4.00
Pascal User Manual & Report Jensen/Wirth	£ 5.90
Introduction to Pascal Welsh/Elder	£ 7.00
Programming in Pascal Peter Grogono	£ 7.80
Microcomputer Problem Solving using Pascal Kenneth Bowles	£ 7.90
OTHER READING	
Cheap Video Cookbook Don Lacaster	£ 4.40
How to Build a Computer-Controlled Robot Tod Loofbourrow	£ 4.90
C207 Microprocessors' Interfacing Techniques Lesea/Zaks	£ 7.90
Computerisation: Layman's Guide for Directors & Senior Management E G Cluff	£ 4.90
How to Profit from your Personal Computer T G Lewis	£ 5.50
Vol 1 Fundamental Algorithms Donald Knuth	£10.50

Books will be despatched within 24 hours or our acknowledgment giving precise delivery date. All prices include p&p within the UK. Outside the UK please add 10%.

For details please contact 30 Lake Street, Leighton Buzzard, Tel: (0525) 376600. When ordering please state your cheque/postal order/Barclaycard number.

• Circle No. 158

video genie system



The Video Genie System, EG 3003. At last, value for money in microcomputers.

£ 425 incl. VAT

- 16K User RAM plus 12K Microsoft BASIC in ROM
- Fully TRS-80 level II software compatible
- Huge range of software already available
- Self-contained, cassette, PSU & UHF modulator
- Simply plus into video monitor or UHF TV
- Full expansion capability for disks & printer



For full details please contact:

LOWE ELECTRONICS

Chesterfield Road,
MATLOCK, Derbyshire, DE4 3HE.
Trade Enquiries Welcome

Telephone 0629 2817 or 2430
Telex 377482 LOWLEC G

• Circle No. 159

SCOTCH STORAGE MODULE THE MEMORY-SAFE.

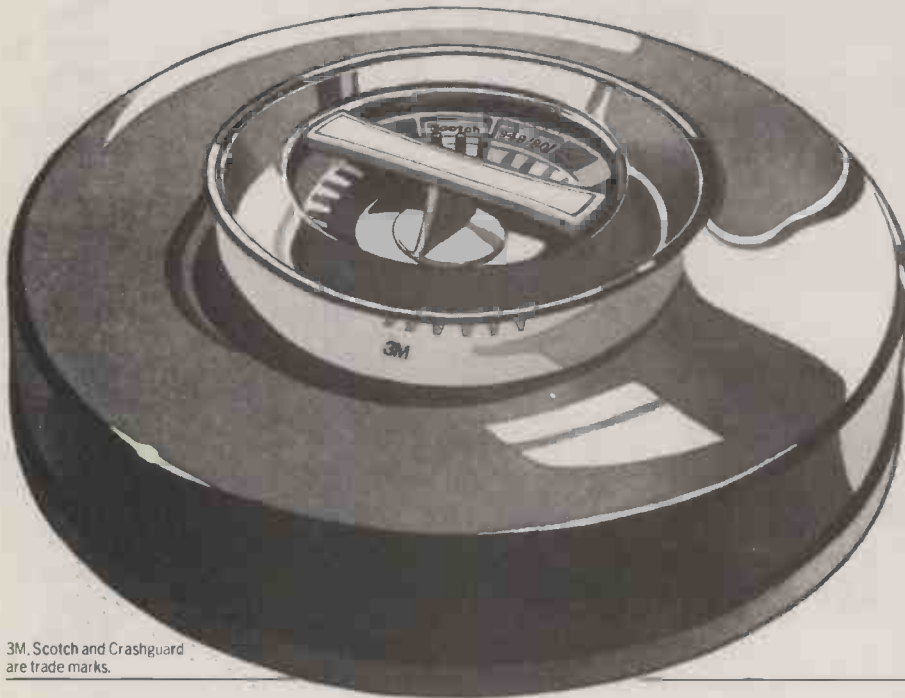

When you entrust your records to a disk storage and retrieval system, you need to be sure that they're safe. And the best insurance you can have is a Scotch Storage Module.

Because built-in to every Scotch Storage Module is all the experience of magnetic coating technology which is why 3M are known as the Magnetic Media Specialists. Like the unique 'Crashguard' binder formulation, which protects you from data checks, damaged disks and heads, downtime and data loss.

Use the 3M Minicomputer Media Service for all your media supply needs. You can order from us direct, or from our network of local distributors.



Find out more.
Phone or write to:

The Minicomputer Media Service,
3M United Kingdom Limited, FREEPOST, Bracknell,
Berkshire, RG12 1BR. Tel: Bracknell (0344) 58502.

3M, Scotch and Crashguard are trade marks.

3M

• Circle No 160

New Low-Cost ASCII Keyboards Ex Stock Delivery



ALL THE ABOVE KEYBOARDS ARE FULLY TTL-COMPATIBLE PROVIDING THE FULL 128 ASCII CHARACTER SET, AND REQUIRING +5V -12V POWER SUPPLY. FULL TECHNICAL DATA AND CIRCUIT DIAGRAMS SUPPLIED.

	Mail Order	Optional Extras:		
KB771 71 Keystations incorporating separate numeric/cursor control pad and installed in a custom built steel enclosure	£95.00	£115.00	KB15P Edge Connector	£3.25 £4.31
KB756 56-keystations mounted on PCB	£49.50	£58.85	KB701 Plastic Enclosure	£12.50 £15.24
KB756MF, as above fitted with metal mounting frame for extra rigidity	£55.00	£64.98	KB702 Steel Enclosure	£25.00 £30.48
			KB710 Numeric Pad	£8.00 £9.78
			KB2376 Spare ROM	
			Encoder	£12.50 £14.95
			DC-512 DC/DC Converter	£7.50 £9.20
			25-Way D-Type connector for KB771	£4.25 £5.46

All equipment is refurbished second-user equipment unless otherwise stated.
All prices subject to carriage & VAT. Trading conditions supplied on request.

BALL MIRATEL VIDEO MONITOR



9in. diagonal P4 phosphor tube. Bandwidth 12MHz (-3dB). Input voltage 220V 50/60Hz 24W. Output voltage +15V DC (short circuit protected) +12kV DC; 12.6V r.m.s. Separate horizontal & vertical sync. Supplied complete with high & low voltage power supplies, amplifier, and attractive moulded plastic housing including space for keyboard. Full technical manual provided.

PRICE: **£95.00**
(total including carriage and VAT £123.00)

NEW SHUGART FLOPPY DISC DRIVES

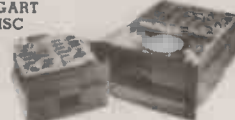

SA400 Minifloppy — 110KB capacity, 35 tracks, transfer rate 125Kbits/sec AV access time, 550msec. Power requirements +5VDC +12VDC

PRICE: **£195.00**
(price including carriage & VAT £235.00)

SA800 Floppy — 400KB capacity, 77 tracks, transfer rate 250Kbits/sec. AV access time 260msec. Power requirements +24DC +5VDC -5VDC

PRICE: **£395.00**
(price including carriage & VAT £468.00)

DIGITRONICS PAPER TAPE PUNCH



Solenoid-actuated unit capable of punching 5 to 8 channel tapes asynchronously. Basic punch contains 8 data, 1 sprocket and 2 transport solenoids plus end-of-tape switch. Pulse amplitude 27VDC. Very compact unit measuring only 6in. X 8in. X 5 1/2in., weight 9 1/2 lbs.

Model P120 (20 cps) **£75.00**
(price including carriage & VAT £92.00)

Model P135 (35 cps) **£95.00**
(price including carriage & VAT £115.00)

RAYTHEON COSSOR UNITEL II VDUs — BRAND NEW SURPLUS

Teletype-compatible display, 15in. diagonal green phosphor tube providing 15 lines of 80 characters (upper case ASCII character set), 6 switch-selectable baud rates (110-2400). Full/half Duplex and buffered mode. Detachable keyboard, Printer port. Dual interface enabling user to select either V.24 (RS232) or 20mA current loop connections. Supplied with operator's handbook and full technical manual.

PRICE: **£295.00**
(price including carriage & VAT £356.00)



ELECTRONIC BROKERS LIMITED
49-53 Pancras Road, London NW1 2QB.
Telephone: 01-837 7781 Telex: 298694.
Our showroom is open MON/FRI 9.1-2.5 (2 mins. Kings Cross underground)

• Circle No. 161

ENSIGN

13-19 MILFORD STREET, SWINDON
WILTSHIRE SN1 1DW
Tel: (0793) 42615 • Telex: 449703

Make more time available to
enhance the quality of your
life and improve your business

COMPUTER SALES • HARDWARE • SOFTWARE • CONSULTANCY • MEDIA • STATIONERY ETC

For less than 25p an hour for just one year you can
COMPUTERISE YOUR BUSINESS NOW!
EVERYTHING YOU REQUIRE TO START
COMPLETE - READY TO OPERATE.

Incl. VAT, Pkg. & Delivery. Nothing extra to pay:

£2,300

- MICROCOMPUTER WITH 48K RAM (Memory)
- DUAL DISK DRIVES (Storage up to 400K)
- DOS DISKETTE (Disk Operating System)
- BOX OF 10 BLANK DISKETTES
- PRINTER WITH TRACTOR FEED
- BOX OF CONTINUOUS STATIONERY/LABELS
- EVERYTHING COMPLETE WITH MANUALS

+ **FREE Programs worth over £500** +
on Diskettes in a Library Case

comprising:

SALES/PURCHASE LEDGERS QUOTE/ORDER/INVOICE
BANK RECONCILIATION STOCKS / SHARES ANALYSIS
STOCK CONTROL MAILING LIST GAMES PACKAGE

This package illustrates how to solve many of your business problems.
They may or may not be suitable for your type of application but they will
help you develop your own software for virtually any type of business.
Worth over £500 this package is enclosed FREE.

SOFTWARE

We are pleased to announce that we have been appointed
Exclusive Distributor for UK, Europe & the World for
GRAMA WINTER SOFTWARE
for TRS 80, Apple, ITT 2020. Also dealer for Pet, Z80, SWTP.

Fully integrated suite of 30 complete business programs.
Usual cost of such Quality Programs would be £2500+.
Complete support, updates, NHI/Tax changes etc.
Write for details.

Special introductory price ... £575 ... inclusive of VAT.

CONSULTANCY

Please write or telephone if you require advice on
BEGINNING or EXPANDING your computer installation.
Software programs customised to your requirements.

OUR BUSINESS EXISTS ON IMPROVING YOUR BUSINESS.

Please send Full Details & Price Lists My requirements are for:

HOME HOBBIES STUDENT BUSINESS

Name :

Street :

Town :

County :

Post Code :

Telephone :

Name of Co :

Position :

PO/Chq No :

(Payment by Barclaycard / Trustcard / Access etc., can be arranged)

We are continually adding new products to our range and would be
pleased to receive your enquiries. ● Quantity Discounts available.

TRS 80		ex. VAT	inc. VAT
4K Level 2	(c/w K/bd, VDU, T/Rec)	434.78	500.
16K Level 2	(c/w K/bd, VDU, T/Rec)	500.00	575.
0K Interface	(to add printer & disk drives)	195.66	225.
16K Upgrade kits	(for k/bd or interface)	65.22	75.
Disk Drives, single	(up to 200K)	260.88	300.
Disk Drives, dual	(up to 400K)	608.70	700.
Disk Drives, dual	(up to 1000K)	1173.91	1350.
Disk Drives, dual	(up to 2000K)	1521.74	1750.
Disk Drives, cable 2 & 4 way from		21.74	25.
Anadex Printer, Tractor feed		434.78	500.
Printer cable for Anadex/Centronics		21.74	25.

APPLE II ITT 2020

16K	(c/w Keybd & Palsoft ROM)	608.70	700.
16K Upgrade kits		65.22	75.
Disk Drive, single with cable		326.09	375.
Printer Interface		108.70	125.
Anadex Printer, tractor feed		434.78	500.
Colour TV ITT 340		239.13	275.

COMMODORE PET

2001-32N	(New keyboard & 32K)	673.91	775.
2040 Dual Disk Drive 343K		673.91	775.
3022 Printer with graphics		521.74	600.
Printer interface and cables, each		21.74	25.

MEDIA LIST

5¼" Verbatim	from (Qty 10)	17.39	20.
5¼" Dysan	from (Qty 10)	26.09	30.
8½" 3M	from (Qty 10)	30.44	35.

Blank 5¼" & 8½" Diskettes, Soft/Hard Sected, Formatted/Unformatted.
We have Diskettes to suit many systems. When ordering please quote:
SYSTEM MANUFACTURER, MODEL, MEDIA TYPE, AND DISK SIZE.
Available in smaller or larger quantities.

STATIONERY Listing Paper, Continuous Forms, Labels.

Listing paper 11" x 8½", white/green music ruled, boxed 2000 £10
Labels 2¾" x 17/16", white, fanfold, £5 per 1000 ... 10,000 for £40

Post/Packing/Insurance extra. Delivery by Registered Post, Securicor, etc.

Price List correct at time of going to Press, subject to change without notice. E.& O.E.
Standard Warranties apply.

Your enquiries assist us in forward purchasing.

Requirements	Description	inc. VAT
Microcomputer	
Upgrade Kit	
Interface	
Disk Drive	
Printer	
Cable/Interface	
Cluster System	
Colour TV	
Media	
Stationery	
Software	
Post/Pkg/Ins	(please tel. for cost)	
PC/PCW/L		TOTAL:

● Circle No. 162

FYLDE MICROCOMPUTER SERVICES

NORTHSTAR EXPERTS
IN THE NORTH-WEST

HARDWARE

STATIC RAM & 2 DOUBLE DENSITY DISK DRIVES WITH 32K £2068
OR 48K £2400

Both include North Star DOS & BASIC software

ELBIT VDU £755
ANADEX DP8000 PRINTER £575

SOFTWARE

CP/M DOS (Extra paper tape utilities, add £5) £75
Cursor controlled TEXT EDITOR £75
CP/M BASIC (Microsoft Version 5 Interpreter) £155
FORTRAN COMPILER £205
TRUE BASIC COMPILER £195
North Star PASCAL which requires 48K £70
BASEX COMPILER with disk handler £68
Interactive WORD PROCESSOR £75
TINY PASCAL COMPILER including source written in PASCAL £28
8080 Assembler £30

Sample programs are available on disk for all the above languages Add £5

GRAMA WINTER Business Software on NorthStar AND CORAL 66 under CP/M ENQUIRE for details

Educational Discounts Available
Prices are Exclusive of
VAT & CARRIAGE

48 Lomond Ave
Blackpool FY99NB
0253 692954

• Circle No. 163

THE SATELLITE VIDEO KEYBOARD TERMINAL



GIVES YOU
MORE ON
YOUR SCREEN

(INCLUDING 128 GRAPHICS CHARACTERS).

The Satellite is based on the KTM Keyboards made by Synertek. The on-board microprocessor gives full control over the display allowing not only the full ASC11 character set to be displayed, but also 64 graphics characters which, with reverse video becomes 128.

An auxiliary serial port allows onward transmission to or from a remote peripheral such as a printer, or modem, and may be switched on and off under software control.

The Satellite comes built and tested. All you need is a monitor (a television and modular may be used with the Satellite 1) and a 5V 1.25A power supply. If RS232 is to be used, then +12 at 100mA is also required.

SATELLITE 1 24 rows of 40 characters £215 + VAT.

SATELLITE 2 24 rows of 80 characters £250 + VAT.

(Dealer Enquiries Welcome).

SPECIFICATION.

- 24 rows of 40 or 80 characters.
- Full 128 ASC11 Character Set. PLUS 128 graphics characters.
- Full RS232 or TTL Serial interface with RS232 handshaking.
- Auxilliary RS232/TTL Serial Port for printer, modem, etc.
- Interlace/non-interlace.
- Line truncate/non-truncate.
- Direct cursor addressing.
- Switch selectable European/USA standard.

INTERACTIVE DATA SYSTEMS 14, BUCKMAN CLOSE,
GREENLEYS—MILTON KEYNES. Telephone: (0908) 313997.

• Circle No. 164

ALGOBEL COMPUTERS LTD.

SIGN OF GUARANTEED QUALITY



33 Cornwall Buildings, 45 Newhall Street,
Birmingham B3 3QR Telephone: 021-233 2407

APPLE II — Software

prices excl. VAT	£
PAYROLL	235
SALES LEDGER	200
PURCHASE LEDGER	200
VAT & CASH BOOK	40
W/PROC & LETTERS WRITER	75
STOCK CONTROL	150
EST.AGENTS, PROPERTY MANAGEMENT	400

* Algobel software is available at your nearest Apple dealer.

Our software packages have been developed in conjunction with Accountants in public practice. Each pack comprises of software on disk, and a comprehensive operations manual. All software covered by 3 years guarantee. Prices quoted are for single pack orders. Attractive discounts are available on multiple orders. Details on request.

• Circle No. 165

MICROSYSTEMS'80

A Conference and Exhibition to
help you come to terms with the
Second Industrial Revolution

at the **WEMBLEY CONFERENCE CENTRE**
JANUARY 30-FEBRUARY 1 from 10 am each day



CONFERENCE SESSIONS enable you to share the experience of experts in the microtechnology field.

A BUYERS' FORUM helps you to establish effective criteria for selection of goods and services.

A PROFESSIONAL DEVELOPMENT SEMINAR introduces managers to the use of microprocessors in business and industry.

AN EXHIBITION where you can talk personally with the suppliers of microtechnology products and services.

Admission to the exhibition is free. You may book in on the spot for conference sessions, or obtain further details of fees and a booking form from:

**MICROSYSTEMS
CONFERENCE**

Room 821, Dorset House, Stamford Street, London, SE19LU.

INNOVATIVE TRS-80 SOFTWARE

- ✓ Business
- ✓ Personal
- ✓ Games
- ✓ Programming Aids
- ✓ Custom
- ✓ Utilities

6 Years Microprocessor Experience!

BINDERS

Our Software List is being updated so frequently now that we are supplying it pre-punched for a ring binder. We are also supplying, without profit, a handsome ring binder which will house the list and also has room for program instructions, notes etc. Large 18p SAE for list alone, 95p plus 50p postage for list and binder.



A.J.HARDING (MOLIMERX)

28 COLLINGTON AVENUE, BEXHILL-ON-SEA, E.SUSSEX.

TEL: (0424) 220391



• Circle No. 167.

COMPLETE COMPUTER SYSTEMS (CCS)



CCS Microsales

LEARN "BASIC" with a **£50**
Voucher towards the cost of
a "BASIC" course when you buy
a micro from us

- ABC80** Z80A based. Fastest in this price range. Fantastic 'BASIC' in 16K ROM plus Assemblers and FORTRAN (disc based) and over 35 Industrial I/O and memory boards.
- APPLE** 48K Disc based WORD PROCESSING Turnkey System inc. IBM Printer only £1990 (ex. VAT) also 12 extra boards from CCS as options to all the usual Apple Boards.
- PET** Our own boxed S100 interface so you can choose from the 200+ index of S100 boards and use them with your PET.
- SORCERER** All sorts of S100 goodies available on order at costs which make it better than the hassel of getting them on your own.

We Know

SEEING IS BELIEVING

and invite you to come and see the ABC80 and others at our new Letchworth shop (Open Nov.) Just clip the coupon and sent it to:
CCS MICROHIRE/MICROSALES
FREEPOST (7 The Arcade)
Letchworth, Herts.

CCS Microhire

Still the Leading Microcomputer Hire Company with the best range of equipment:

PET (8K) now £4.20/day*
APPLE (16K) now £5.70/day*
Apple II; PET; Exidy Sorcerer; SEED System One/MSI 6800; NASCOM/MICROS; Research Machines 380Z and Tandy TRS-80.

Over 500 million Bytes (half megabytes memory) available for hire in units from 4K to 48K.

Send for our NEW PRICE LIST giving the most attractive prices yet.

* four day rates

CCS MICROHIRE
FREEPOST (7, The Arcade)
LETCHWORTH, HERTS SG6 4YA

I would like to come and see the ABC80; PET; APPLE.
Please call me back to arrange an appointment.

NAME

Company

Location

Tel. Ext.

• Circle No. 168

NEW

from

TANGERINE

COMPUTER SYSTEMS

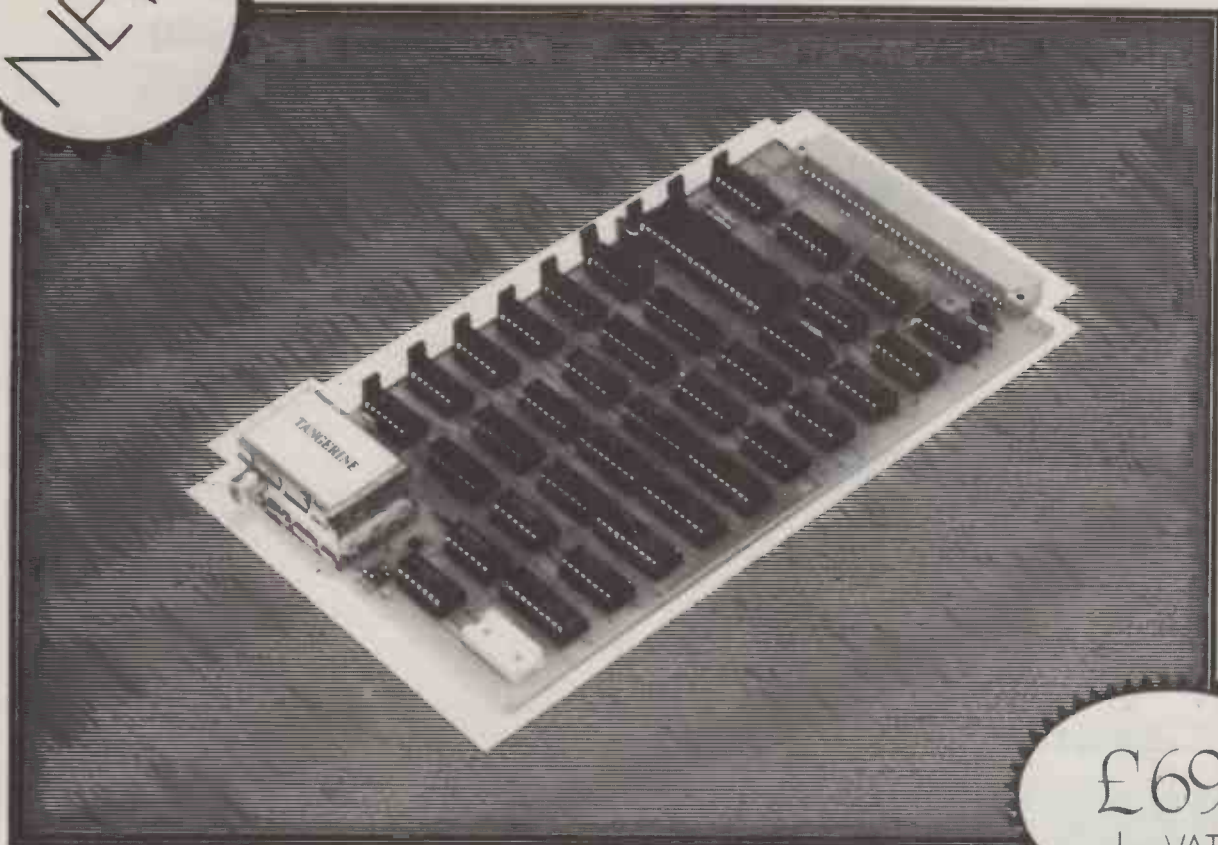

£69 plus VAT

microtan 65

- A 6502 based microcomputer
- Superb 1K monitor TANBUG
- 1K RAM for user programme, stack and display memory
- VDU alphanumeric display on un-modified domestic T.V. of 16 rows by 32 characters
- Optional lower case pack making a total of 128 displayable characters
- Optional chunky graphics (64x64pixels)

EXCELLENT DOCUMENTATION

TANBUG

The most powerful 1K monitor available - TANBUG. Offers memory and register examine, modify and list, block moves, single instruction, multiple non-destructive breakpoints with ability for multiple passes, address offset calculation and many other useful features.

EXPANDABLE

TANEX - Expands the microtan 65 into a system. Provides 7K RAM, 6K ROM, 8K BASIC, 3 serial I/O (including RS232/20mA), 32 I/O lines and 4 16 bit programmable timers

AVAILABLE EX-STOCK FROM -
TANGERINE COMPUTER SYSTEMS,
FOREHILL, ELY, CAMBS. TEL: ELY 3633

Please send me:

Microtan 65 kit - 79.35p Tanex kit min config - 49.45p

Microtan 65 assembled and tested - 90.85p

Lower case option - 10.95p Graphics option - 7.99p

20 way keypad - 7.99p Full details, 10p stamp please.

Name and address.

Prices include VAT Please add 150p for P & P

• Circle No. 169

CHROMASONIC electronics

your soundest connection in the world of components

Dept PC, 58 FORTIS GREEN ROAD, MUSWELL HILL, LONDON, N10 3HN
TELEPHONE: 01-883 3705/2289

DYNAMIC RAMS

DYNAMIC RAMS	1+	8+	16+
4027	£3.46	£3.16	£2.86
4116 (250 ns)	£7.75	£7.25	£6.57
4050 (200 ns)	£2.87	£2.58	£2.30
4050 (350 ns)	£2.70	£2.43	£2.09
4060 (300 ns)	£2.75	£2.47	£1.99

STATIC RAMS

STATIC RAMS	1+	16+	64+
2102A	£1.33	£1.19	£1.04
2102A-2	£1.33	£1.19	£1.04
2111A-1	£1.95	£1.75	£1.58
2112A-2	£2.11	£1.93	£1.80
21102	£1.33	£1.19	£1.04
MM 5257 (TMS 4044)	£7.97	£7.37	£6.90
MM 2114	£7.97	£7.37	£6.90
MC 6810	£3.48	£3.08	£2.68
4035 (1000 ns)	£1.23	£1.14	£1.02
4045 (250 ns)	£7.07	£6.55	£5.89

ROMS

2513 (Upper Case)	£7.18
2513 (Lower Case)	£7.18
MM 5230	£5.31

EVALUATION KIT

6800 D2 kit	£195
-------------	------

BAUD RATE GENERATORS

MC 14411	£6.75
MM 5307	£10.79

CPU E-PROMS

8080	£ 5.84	1702 AQ	£ 5.93
6800	£ 6.91	2708 Q	£ 7.20
9900	£29.95	2716	£27.59

T.V. CONTROLLER

SFF 96364	£16.77
-----------	--------

VAT inclusive prices at 15%. Export customers deduct VAT 3/23

BARCLAYCARD

VISA

Postage and Packing 25p. Trade and Export Inquiries most Welcome. Hours 9.00am - 5.00pm. Now available our ORDER RING line, just phone your order through with your Access or Barclaycard number and providing the order is received by 3.00pm the components will be despatched the same day (minimal order £3.00)

Buy it with Access

UARTS

AY-5-1013	£4.20
MM 5503	£5.79

BUFFERS

81 LS 95	99p	74L S00	.17p
81 LS 96	80p		.17p
81 LS 97	99p		.18p
81 LS 98	80p		.22p
SN 74365	60p		.22p
SN 74366	60p		.14
SN 74367	60p		.28
SN 74368	60p		.30
8T 26	£2.80		.51
8T 28	£2.80		.76
8T 95	£1.80		.78
8T 96	£1.80		.95
8T 97	£1.80		.126
8T 98	£1.80		.151

INTERFACE

8205	£3.45		160	£1.25
8212	£2.31		163	.80p
8216	£2.39		166	£1.90
8224	£3.19		170	£1.98
8228	£4.75		192	£1.20
8251	£5.75		193	£1.20
8253	£7.97		194	.99p
8255	£5.84		195	£1.12
			221	£1.12
			253	£1.06
			221	£1.06
			253	£1.06
			279	.65p
			283	£1.25
			293	£1.05
			348	£1.60

L SERIES

74L 90J	£2.59
---------	-------

S. SERIES

74 S00	£0.65p		365	.54p
74 S387	£2.68		366	.54p
74 S474	£12.93		368	.54p
74 S262	£12.00		393	.97p
			668	£1.35

SPECIAL OFFER:

Only for readers of Practical Computing

DIABLO 1640

32-64K* Z80 SYSTEMS, PERIPHERALS, BUSINESS SOFTWARE, APPARAT AND SMALL SYSTEM SOFTWARE PRODUCTS AVAILABLE

* TANDY IS A TRADE NAME OF RADIO SHACK.

DAISYWHEEL RECEIVE ONLY PRINTER

immaculate typewriter quality print

RS232 INTERFACE

£1849 plus v.a.t.

usual price £2091. FULL MANUFACTURER'S

%* DAY WARRANTY

TRACTOR FEED AVAILABLE

AVAILABLE AT THIS PRICE FOR ORDERS RECEIVED

BEFORE FEBRUARY 14TH 1980 SUPPLIES LIMITED -

FIRST COME FIRST SERVED - HP AVAILABLE

Clip coupon to order or phone COMPUT-A-CROP for details
01-499 6987

NAME _____

ADDRESS _____

Please supply _____ DIABLO 1640R0'(s) £1849 plus vat

SIGNED _____

cheque/remittance enclosed £ _____

Return to: COMPUT-A-CROP 184, Streatham High Road,
London SW16 1BJ Delivery free within GLC area, and at cost
on UK mainland.

• Circle No. 170

• Circle No. 171

C.J. Communications

FLOPPY DISKS

Our high quality disks are manufactured in Santa Clara, California.

All disks are delivered free of defects in materials and workmanship.

Performance is guaranteed for a minimum of 12 months.

5¼" SINGLE £24.75 per 10

" DOUBLE £32.40 per 10

8" SINGLE £26.50 per 10

" DOUBLE £44.15 per 10

Also available in single units

PLEASE SPECIFY EQUIPMENT WHEN ORDERING

CONTINUOUS FORMS

We offer a comprehensive form design service to meet your special requirements.

Send details of your needs.

Stock forms

11" x 8½" (2,000s) £9.50

11" x 9½" (2,000s) £10.60

All our prices include VAT and delivery. SAE for lists

9, DALE CLOSE, TODDINGTON,
Nr. DUNSTABLE, BEDS. LU5 6EP.

Tel.: (05255) 2207

• Circle No. 172

nm

Nascom Microcomputers

No 1 & 2 for choice!

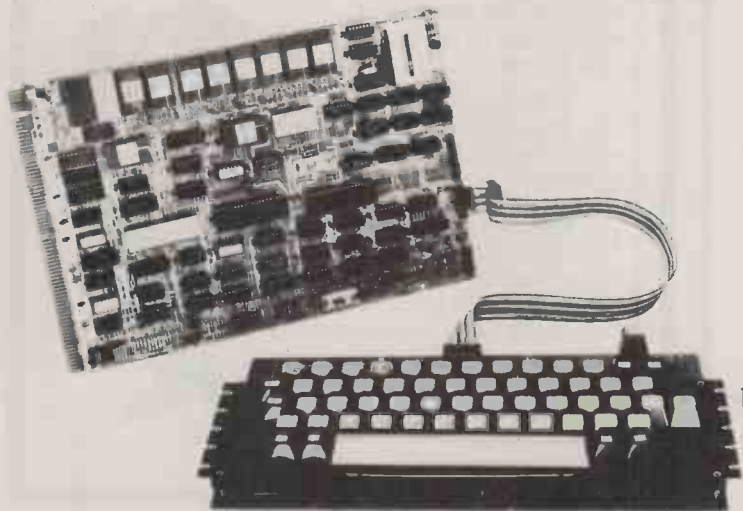

NASCOM - 1 or 2. This ever popular all British microcomputer which comes factory fresh as supplied by the manufacturer. A whole range of options and expansions both hardware and software are available now.

Price: NASCOM - 1 £165.00
NASCOM - 2 £295.00

DC 80 - 1 or 2. This new desktop version of Nascom is intended to help the hobbyist or professional. Fully assembled with power supply basic and desktop case suitable for both Nascom - 1 and 2 versions, this adds a new dimension to this British micro.

Price: DC 80 - 1 £330.00
DC 80 - 2 £460.00
Case Only £35.00



BCC 80 - 1 or 2. For the traveller or user who requires a mobile computer, this portable computer is available with Nascom - 1 or 2. It comes with a variety of options including an acoustic coupler for remote communication via a telephone handset.

Price: BCC 80 - 1 £405.00
BCC 80 - 2 £535.00
Case Only £85.00

All prices are subject to change without notice and are exclusive of VAT at the current rate

PML offer a full range of Nascom equipment, ask for our price list and similar versions of the Rockwell AIM 65

P.S. We will shortly be offering a NASBUS to S100 expansion and conversion motherboard which will fit inside the DC 80 case



**Portable
Microsystems
Limited**

Forby House, 18 Market Place,
Brackley,
Northants NN13 5SF
Telephone Brackley (0280) 702017
Telex Micro 83147

• Circle No. 173

PADMEDE



Padmede's own commercial apple software, all systems in regular business use.

Incomplete Record Accounting	£450
Time and Cost Recording	£300
Job Costing	£300
Order Processing	£250
Sales Ledger	£300
Purchase Ledger	£300
Selective Name/Address Reporting	£150

Complete Ready to go kits including diskettes and comprehensive manuals

VISICALC ... £100.00

Already successful in U.S.A. this software should be useful to Engineers and Accountants alike; it will be particularly attractive to business executives for FINANCIAL MODELLING

PADMEDE HARDWARE

The entire range of Apple products plus IEEE interface card £216.00

Padmede 801 Impact printer simple, quiet, reliable, 132 C.P.S. £675.00

Genuine NTSC 12" colour VDU, especially imported £530.00

VAT must be added to all prices shown

Let our several years software and hardware experience of the apple computer solve your problems. Enquiries from apple dealers welcome. Please quote P/12/ when ordering.

PADMEDE COMPUTER SERVICES
112/116 HIGH STREET,
ODIHAM, NR: BASINGSTOKE; HANTS.
TEL: ODIHAM (025-671) 2434

• Circle No. 174

MEET THE LITTLE GENIUS

If you find self-instruction manuals difficult to follow, then meet our Little Genius.

Little Genius floppy diskettes are the fastest, easiest way to master your micro.

Little Genius will save you time and effort, teaching you to exploit all your micro's facilities.

Courses on Basic and Advanced Basic are available now. For a free demonstration or more information ask your local dealer or contact Peter Brown at Suite 504 Albany House, 324 Regent Street, London, W1R 5AA. Telephone 01-580 6361.



• Circle No. 175

Commissioning Editor

If you have a solid background in electronics, a good knowledge of current needs and trends and experience in book publishing, then there is an ideal opportunity for you with Newnes Technical Books as a Commissioning Editor.

Your role will be to sign up suitable authors for a wide range of books on subjects that include electronics theory and construction, personal computer principles and programming as well as electrical and electronics servicing and repair.

Ideally you would have an academic qualification although this is not as important as enthusiasm, application and an editorial flair.

Salary negotiable around £7000 according to experience + company car.

Our modern offices are in pleasant rural surroundings, about 50 minutes from London.

Applications in writing to:

Linda Stammers,
Personnel Assistant,
Butterworth & Co. (Publishers) Ltd.,
Borough Green, Nr. Sevenoaks, Kent.



Butterworths

• Circle No. 176

which computer?

which software?



As a major APPLE II distributor we can supply a variety of proven software packages developed by us.

Fully Integrated Ledger System

Gives management information, i.e. aged accounts on individual clients, sales analysis, etc.

inclusive of Payroll	£1215
exclusive of Payroll	£ 855

Payroll only **£ 360**

Accepts the following varieties of tax codes:

- All the basic codes
- Cumulative Suffix
- Wk 1/Mth 1 Basis Suffix
- BR (Cumulative)
- BR (Wk 1/Mth 1)

Budgetary changes to tax codes take approximately 10 minutes.

Stock/Purchase/Order Invoicing Program **£ 285**

Either stand alone – or can form part of our General Ledger System.

The above programs work either on 48K twin floppy system or a version for 10Mb Corvus hard disk drive is available.

Also developed by us is the Word Processing/Letter Writer Program at £120. A powerful system for creation and manipulation of words, which the system will organise into documents formulated precisely to your wishes.

Cash Flow/Bank Forecast **£ 80**

Automatically updates all data following each alteration of an item. Gives column and line totals. Saves a lot of boring work when a Company operates with more than one bank account.

To improve your APPLE II system we offer the following hardware:

Mains Suppressor	£ 35
Upper and Lower Case Generator	£ 80
or	
ROM Plus Card with Upper and Lower Case Generator	£120
Case to accommodate 2 disk drives and Hitachi 9-in. monitor	£118



Contact: Vlasak Electronics Ltd., Thames Building, Dedmere Road, Marlow, Bucks.
Tel. Marlow 74789

OR ASK YOUR DEALER FOR VLASAK SOFTWARE DEMONSTRATION

• Circle No. 177

Stop puzzling over the Micro Jigsaw and buy an operational system to fit your needs

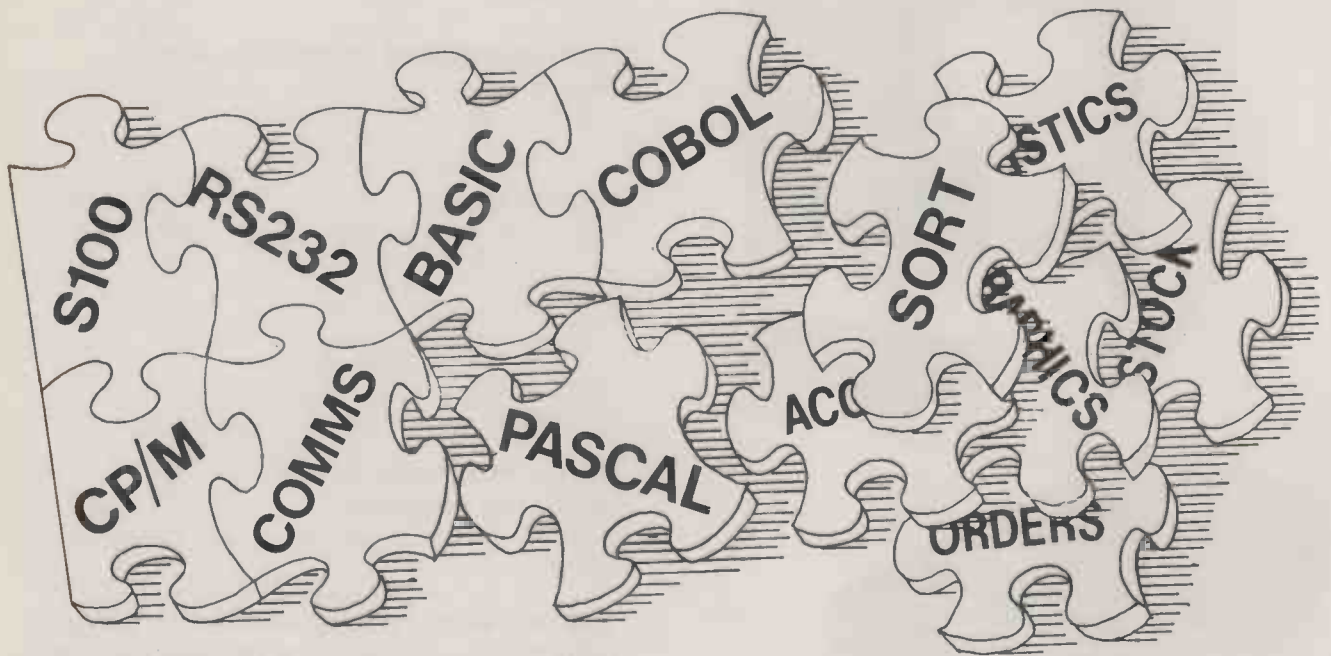

If only buying a microcomputer system was as simple as using one.

Just look at the advertisements in this magazine. When can you find time to digest them all?

There are millions of chips, thousands of boards and hundreds of peripherals, software systems and application packages. How do you pick the right ones to meet your requirements?

And put them together? And make them work? And add the specials you want?

At Digitus we have computer professionals working full-time putting systems together. Absorbing information. Testing equipment and software. Writing programs. Training users.

At one stop you can commission a complete system to fit your requirements.

Last year we supplied systems for: number processing, word processing, data processing,

graphics and machine control. Advised accountants, surveyors, archaeologists and engineers. Helped DP departments and small business men. Developed software for personnel, incomplete records, order processing, business games, linear programming, process control and terminal emulation. And were retained by other computer companies to advise on micros.

This year we can put even more experience to work so that you can benefit from micro technology ... in comfort.

Come and see us. Spend a few hours discussing your requirements. Attend a training course. Select a machine. Test drive some software.

Solve the micro puzzle. Buy an operational system that fits your needs.

Call for an appointment with one of our consultants.

Digitus

Digitus Limited Microtechnology Centre Dumbarton House 68 Oxford Street London W1 Tel: 01-636 0105

• Circle No. 178

'Please Mr Editor, what computer should I buy?'

ON A GOOD DAY, the phone will ring only once with this insidious question: "Please Mr Editor", the unknown voice will say, "What computer should I buy?". It is so regular, though from many an unknown tongue, that I can hear the music tinkling in my head. 'Ring Ring. Please Mr Editor ...'

But since we are a fully interactive hands-on magazine we ought to have some sort of answer for these good people, who turn to us in their understandable complexity. 'Well,' I say cagily, 'what do you want it for?' To begin with, this seems a good question; but now it is only stalling for time, because without listening I can hear the answer: 'Small business — fascinating — wonder chip — transform our lives — fascinating — son of a friend of mine — VAT sort of thing — absolutely fascinating.'

Having thus thoroughly explained his requirements and put the Editor in possession of all the material facts, the invisible caller sits back and waits for words of wisdom.

It might seem that the brief is somewhat skimpy. Yet, not long ago, I was sent a three-page questionnaire by a gentleman employed by a large and highly technological company to look into the whole micro-computer question. These were the questions he proposed to ask persons who wanted to supply him with micros. But, at the last moment, he asked himself: 'Have I perchance left some pertinent question out?' To make sure, he sent it all here and asked whether we could think of some tricky number that would utterly floor the wily manufacturer.

Well, I was baffled. I looked at his questions and wondered what sense one could make of all the answers if and when one had got them answered. There is such a thing as knowing too much. It was as if he were thinking of buying a car, and asked the dealer whether the crankshaft bearing journals were cyanide — or radiation-hardened.

The answer is: it doesn't really matter. Cars run; computers compute. If yours does not, then you send it back and get another.

We have got to the stage in micro-computers where hardware is not really a problem. The stuff does actually work most of the time. True, we have a hundred-odd different machines in our hardware buyers' guide (published alternate months with the software guide) and in some cosmic sense, one must be 'better' than all the others. But that cosmic sense is quite inaccessible to our coarser perceptions. Broadly speaking, you get what you pay for. You won't get a system with a megabyte of disc and a good printer for £300; and anyone who offers you such a bargain should be carefully scrutinised. It is true, too, that the very cheapest computers get that way because their manufac-

turers use sub-standard chips, sold as unbranded seconds by the semiconductor houses. If you open the beast up and find a lot of anonymous-looking chips inside, be wary. But apart from that, the only hardware thing to worry about is perhaps high-definition graphics. If pictures are what you want, then the choice is somewhat limited. But that aside, the available computers are all much of a muchness.

There are really only two questions. The first is: what do you want it for? Do you want to write your own programs or run someone else's? If the first, then you can skip this part. If the second, then our problem is not so much hardware as software. If you need some large, competent program, then that is what you have to look for.

Having found it, you ought to see it running in some other customer's premises. You should talk to him and find out how many nervous breakdowns it gave him and his staff. Do not be content simply with a dealer's demonstration and assurances of the program's surprising competence and crashproofness. Unless you have an iron constitution, do not be the first to buy.

The second question is: once you have found some software which seems likely to do what you want, on what machine will it run? Having chosen a machine in this unadventurous way, you look very closely at the chap who sells it to you, because you may well find yourself in a more intimate relationship with him than with your wife.

If things go wrong, you will be seeing a lot of him and you will need his skill, intelligence, patience and good humour. Study his profile carefully. Is there a hint of petulance in the mouth? Is the jawline stubborn? The forehead weak? These are far more important questions than the capacity of the X register, or the read-write time of the RAM.

The fact is that all computers have some virtues and all have some faults. Whatever the particular virtues of yours, you will come to cope with them without a thought. It is like husbands and wives: you look at other people's and ask yourself 'How could they!' Much more important than the texture of your beloved's cheeks is the dowry of software she brings with her and the readiness of her in-laws to pick her up if she falls over.

So when the phone rings and another trusting voice begins the litany: "Please Mr Editor ..." I'm afraid I talk less about bits and bytes than trying to indicate — subtly, of course — the sort of person one wouldn't want to buy a computer from — ever.

It may look like the white-hot technological revolution at first, but like almost everything else in life, it all comes back to people in the end.

At last! The Software Buyers' Guide

FOR A LONG TIME now we have been giving enquirers the advice sketched out above: hardware is less important than software. 'Very well,' they reply petulantly, 'kindly advise us. What software should we buy?' And then, after a pause, they start to explain about unhelpful magazines who don't tell you what you most need to know.

Well, there was a reason for the pause, and that was until the last few months, there hasn't

been any software for small businesses, worth the name. Although the micro-revolution burst on us quite quickly, it burst a lot less fast than the more ecstatic publicity.

And so often in computing, the innocent bystander is left with an impression that things can be done which leave computer professionals gasping and wondering just how many years it is until 2001 and whether someone

hasn't torn several important pages out of the handy desk-top century-planner.

So, now we start to catch up with ourselves. On page 133 you will find Mike MacDonald's analysis of the small business software scene, followed by 10 tightly-packed pages listing the packages we know about. We guarantee nothing about them, except that their proprietors say they exist. Later on, we shall be reviewing them in merciless and cynical detail.

InterSystems

PASCAL MICRO DEVELOPMENT SYSTEM ON THE DPS-1™ MAINFRAME

FOR LESS
THAN
£3,000

Develop real time applications programs for Z80 micro processors using
the popular CP/M operating system and the Ithaca Intersystems
PASCAL/Z™ COMPILER

Join the many Educational and Industrial users



A TYPICAL SYSTEM CONSISTS OF

- DPS-1 IEEE S100 Mainframe
- Z80A 4MHz cpu S100 Board
- 64K bytes RAM S100 Board
- 1M byte double density disk system with
- Twin 8" Shugart drives, CP/M and PASCAL/Z
- RS232 console connection

IDEAL FOR EDUCATION

PASCAL COMPILER FOR CP/M USERS

Forget slow P-code interpreters ● Compiler that produces Z80 macro assembler code

only
£165

We have a full range of OEM S100 boards & SOFTWARE

K2 Operating System

8" disk based operating system — distributed on Shugart compatible 8" floppy disk.

Disk controller (up to 4 single or double sided drives)

I/O board (4 parallel and 2 serial ports) with interrupts

I/O board (4 parallel and 2 serial ports) less interrupts

S100 front panel (as used in DPS1)

Analogue I/O board

8K Static RAM board (450ns)

8K Static RAM board (250ns)

16K Static RAM board (450ns)

16K Static RAM board (250ns)

64K Dynamic RAM board (250ns)

Z80 cpu board (2MHz)

Z80 cpu board (4MHz)

2708/2716 EPROM board

Prototype board (bare board)

Video display board (64 x 16, 128U/L Ascii)

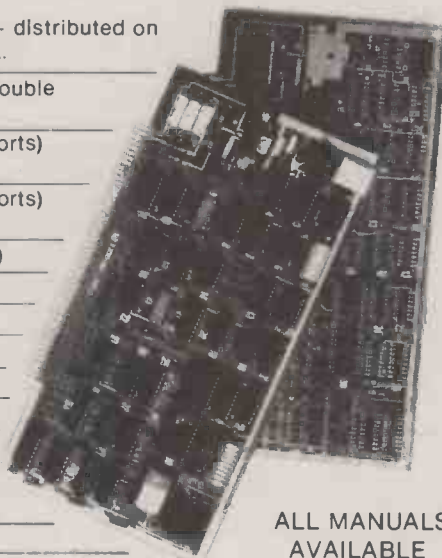

ALL MANUALS
AVAILABLE
SEPARATELY

SINGLE BOARD OEM COMPUTER

AVAILABLE NOW: ZBC-1 Single board computer for OEM market. Available in basic through to fully expanded. 4MHz Z80A, 64K RAM, memory mapped 4K screen buffer, composite video, up to 16K power on EPROM monitor, 4 parallel ports, 2 serial ports, 4 channel counter timer. Please phone for a quote for your needs.

(quantity discounts available)

Remember, IEEE S100 boards must have 8 or 16 bit data and 16 or 24 bit address capability.

OUR NEW CATALOGUE OF
OEM BOARDS & SYSTEMS
IS OUT NOW

™ DPS-1 and PASCAL/Z are trade marks of Ithaca Intersystems

All prices quoted are exclusive of VAT

ITHACA *InterSystems*
(formerly ITHACA AUDIO of New York)

EUROPEAN SUBSIDIARY
58 Crouch Hall Road, London N8 8HG. England.
Telephone: 01-341 2447
Telex: 299568

• Circle No. 179

College software contest

A SOFTWARE COMPETITION for schools and colleges is being organized and financed by the Computing Laboratory of the University of Kent. The winner will receive a Kent Software Trophy and £300 in cash. There will be 20 merit prizes of £10 each.

Entrants must submit a computer program of practical use in commerce or industry, not for education. Short programs, however, are acceptable and the organizers believe that a program of only 20 lines, covering some imaginative application, could well win a prize. Anything written after September 1979 can be accepted. The competition is divided into two classes — under 17 and under 19 on the date of entry. Groups can enter in each class, but each member must be a full-time student at a school or college. Universities and polytechnics are excluded.

Entry forms are available from Kent Software Trophies, Computing Laboratory, The University, Canterbury, Kent CT2 7NF. The final closing date is February 16th, 1980.

By Jupiter! Have no fear

PROBLEMS with lightning? Lighting Elimination Associates (LEA) have had years of experience in its elimination — “a full consultancy and design service on lightning eliminators is offered to manufacturers and distributors.”

Though not the 20th century's answer to repentance, the company does manufacture units to protect logic circuits from lightning-induced surges which can damage logic circuits many miles from the strike.

The LEA 'Kleanpower' power-line filters are designed to provide a very 'clean', interference-free mains supply to sensitive computers.

Contact LEA Ltd, Vine Cottage, Moreton, Thame, Oxon, tel: (084 421) 3204.

Now a laser network?

AMERICAN oil giant Exxon is reportedly planning a private communications network based on laser light transmitted through fibre-optic cables.

● See Networks cover story, page 72.

Talkback Tina won't keep you waiting

A COMPUTER system which can be programmed in plain English has made an appearance.

Called TINA, it will be marketed by Unilever through its office equipment distribution chain, BEAM, and is manufactured by Logical Machine Corporation (LOMAC). TINA is aimed at the small/medium business market.

Programming in English is not as easy as it sounds. TINA starts with a vocabulary of only 40 verbs, many of which are similar to Basic commands such as SAVE. But the operator can enter as many nouns as he requires, to use with the verbs, and can build up his own files.

Any line of a 'program' can be altered with a few keystrokes and if the operator loses his way all the verbs, nouns and files created can be recalled on the screen.

After each entry is accepted, TINA returns with the question "What do you want to do next?" There is no direct guidance on how to use the system and clearly training will be needed. Even so, BEAM hopes that TINA will help eliminate the mystery surrounding

data processing for the average businessman.

The company is reluctant to divulge technical details, but says of TINA's response time: "You won't be left sitting at the keyboard waiting for TINA."

With training, the system may save the businessman the cost of more conventional programming, but to create any major files is certain to be a time-consuming task.

TINA is priced at £11,500 and includes a VDU, keyboard and a dual floppy disc drive, each with capacity of 1.25MBs. One disc stores the vocabulary while the other stores the file data. An unusual feature in the disc drive is a rechargeable battery which powers the transfer of all screen data to the discs in the event of a power cut. When power is restored, the system returns to its previous status.

TINA already has a larger brother, called ADAM, and LOMAC is planning a baby version, called ABEL, which could be ready for launching in about nine months.

Further details: BEAM, Centurion House, 129 Deansgate, Manchester M3 3WL.

● We hope to review TINA within the next few weeks.

Beginner's guide to Level II

DR DAVID LIEN, the well-known author of the TRS-80 Level I Users' Manual, has unveiled his new book, *Learning Level II*, which covers all Level II Basic. It is written for those who have not yet learned Level I and guides readers, step by step, through the fundamentals and special characteristics of Level II, beginning with setting up the system.

The manual explains how to use the Editors, both while learning and when custom-writing special programs. One section is devoted to showing how to convert Level I programs to Level II, including all the users' programs in the Level I manual.

The new guide also explains the complete range of Level II TRS-80 features. These include dual cassette operation, using the expansion interface box with the real-time clock, printers and other peripherals.

Learning Level II can also be used with other computers since the Level II Basic interpreter was written by the same organization that wrote the interpreters for the PET, Sorcerer and the OSI. There are many similarities.

Learning Level II (\$15.95 + \$1.45 pp) may be ordered direct from computer Books Division, CompuSoft Inc, 8643 Navajo Road, San Diego, CA 92119.

End of the line for QWERTY?



THIS ERGONOMIC KEYBOARD, called the 'Trolley System', is claimed to increase typing speeds by up to 40% — fast enough to allow dictation to be typed directly.

Developed by PCD Ltd, it is a mobile word-processor unit, complete with VDU and floppy disks. Ten of the systems, priced at around £7000, have been ordered by the Department of Trade and Industry through their pre-production support scheme and will undergo proving

trials this year with local authorities, a patent agent and a secretarial bureau who will be arming one of their temps with it.

Efficient keyboard layouts have been available ever since QWERTY was adopted after erroneous calculations of letter frequency by a school maths teacher, but they have never caught on. Perhaps this time will be different.

PCD Ltd is based at 42 Queens Road, Farnborough, Hants, tel: (0252) 511001.

LOGITEK

The ALTOS Sun Series ACS 8000 BUSINESS/SCIENTIFIC micro computer creates a new standard in quality and reliability in high technology micro computers.

HIGH TECHNOLOGY

The ACS 8000 is a single board, Z80 disc-based micro computer. It utilises the ultra reliable Shugart 8 inch, IBM compatible, disc drives, double density – single sided, and providing 1 M. byte of data storage. The ACS 8000 features the ultimate in high technology hardware: a fast 4 MHz: Z80 CPU, 64 kilobytes of 16 K dynamic RAM, 1 kilobyte of 2708 EPROM, an AMD 9511 floating point processor (OPTIONAL) a Western Digital floppy disc controller, a Z80 direct

memory access (OPTIONAL), Z80 parallel and serial I/O (two serial RS232 ports, 1 parallel port), and a Z80 CTC Programmable Counter/Timer (real time clock).

BUILT-IN RELIABILITY

The ACS 8000 is a true single board micro computer. This makes it extremely reliable and maintainable. The board and two Shugart drives are easily accessible and can be removed in less than ten minutes. All electronics are socketed for quick replacement. Complete diagnostic utility software for drives and memory is provided.

QUALITY SOFTWARE

Unlimited versatility. The ACS 8000 supports the widely accepted CP/M disc operating system plus basic (Microsoft and C Basic), Cobol, Pascal, and Fortran IV. All available now.

Logitek in conjunction with its own microsoftware house, Interface Software Ltd. of Camberley is able to supply a wide range of proven 'off the shelf' business software including general accounting, word processing, stock control, mailing list etc.

There are already over 1000 micro computer installations using this software. A track record which we consider speaks for itself.

ALTOS



Why 're-invent the wheel' when there is standard software of this quality available now?

If you are a dealer who may be interested in promoting the ALTOS and/or Interface Software contact Logitek. We can offer something rather special – now!

SUN-SERIES 8000

IN ESSENCE, THE BEST IN INTEGRATED CIRCUIT TECHNOLOGY

LOGITEK

E.I.C Electronics Ltd.,
30 Kelvin Ave, Hillington Industrial Estate, Glasgow. G52 4LH.
Tel: 041-882 1166/1661/1662. Telex: 777255
sales enquiries to
Portland Street, Chorley, Lancs. Tel: Chorley 66803.

• Circle No. 180

Bar code labels for hobbyists

WITH A GROWING number of bar code products for microcomputers, we have been asked where the hobbyist, or small businessman, can print small quantities of bar code labels.

Plessey run a bureau service, from Sopers Lane, Poole, Dorset, which charges £20 per thousand labels if the numbers are sequential. There is a minimum order of £15. Random numbers are likely to be more expensive. To check, by telephone, try Mr Armitage on (02013) 5161 ext 2318.

Libraries have often been suggested as an alternative source. Many have their own printing machines. No library, however, appears to offer this service already, despite the extra revenue the service could earn.

One reason is that they have simply not thought of it. Several libraries seemed sympathetic to the idea but would have to ask for a policy decision by the library director if there were a formal request.

It is likely, however, that most libraries will reject any request, as labels printed for hobbyists could be used to side-step the library's book security and control systems.

Expandable system

A 16-BIT MICROCOMPUTER which will accommodate 8-bit microprocessors has been developed by a small London company for systems builders and software houses uncertain of the hardware for future application software.

It can use either 8 or 16-bit microprocessors and is not dependent on one manufacturer's chip. The system can be expanded either as a single unit or multi-processor configuration.

The Microflex 1001, developed by Quinebal Data Systems Ltd, starts with 48K RAM, 16K PROM, a dual floppy disk unit and two serial and two parallel ports. It has a dual bus DMA structure, CRT mapping module for word-processing and can be expanded to control up to eight disk drives.

Contact: QDS Ltd, Regina House, 1-5 Queen Street, London EC4 1FP. Tel: 01-248 7421.

● PHILIPS have entered the same market as Currys with G7000 computer video games system which plugs into a television. It has an alphanumeric keyboard and joysticks, and can be programmed, with cartridges, from 'golf' to mathematics, spelling and logic. There is now also a cartridge course in basic computer programming.

High Street retailer jumps on bandwagon

A HIGH STREET retail chain believes that over one million home computers will be sold by 1985 — and is backing its belief by setting up a subsidiary to handle sales.

After more than 12 months of discussions, electrical goods chain Currys will market microcomputers and applications packages in 40 of its branches during 1980. It also intends to set up specialist retail outlets.

The new subsidiary is headed by former GEC chief Derek Moon and Robert Webb, formerly of Commodore International.

Currys managing director Terry Curry told *Practical Computing* that he intends to "dominate the market" and his move is likely to threaten many smaller independent outlets.

Prime targets for the microcomputers and software packages will be small to medium businesses and industries, commercial and educational outlets and professional practices. The domestic market is also considered important but Currys does not see the hobbyist as a key target.

The philosophy behind the move is very similar to Radio Shack's when they launched the TRS-80. By selling and promoting microcomputer systems, Currys hope that a high-technology image will rub off onto the rest of their product line.

Software has been commissioned from outside sources. Every product will be tested independently before going onto the market, and most bugs will be eliminated, claim Currys. It is not so clear how they intend to support the software.

The new company is cagey about which systems will be sold and where the software is being written, or adapted. But since Robert Webbsian ex-vice-president of Commodore's computer division, and Kit Spencer, of Commodore UK, were involved in some of the early discussions, the Pet, with over 20% of the UK market, must be the prime candidate.

At the upper end of the market, there is room for more speculation. Currys expect Japanese and other Far Eastern manufacturers to become major competitors of American manufacturers during 1980 and although there will be little software immediately available, it is unlikely that this important source will be ignored.

In the short term, with over 18,000 Pets already installed in the UK and with a wide range of software available, the temptation must be to look for systems upward-compatible with the Pet.

This raises the possibility that the CompuThink MiniMax could be under consideration — it uses the same disc drives as supplied for the PET through ACT Petsoft.

The Minimax will also be sold by

by Duncan Scot

ACT under the names of ACT 8/08, ACT 8/16, ACT 8/24 and ACT 8/48. The last two figures refer to the storage capacity (ie 800KB, 1.6 MB etc). If this is the case Currys might only sell Pets with the CompuThink disc drives, supplied by Petsoft.

But no firm decisions appear to have been taken yet and it is unlikely that any contracts have been signed. Eventually Currys may prefer to sponsor independent evaluations of systems, and possibly software. One venue where the idea has already been discussed is the Polytechnic of the South Bank, in London, where a 'Microcomputer Advisory Centre' to be run by Sue Eisenbach is under consideration.

See *Minimax review*, page 61.

● HIGH STREET retailer, Dixons, has set up a subsidiary, Advanced Consumer Electronics, to market and manufacture electronic equipment. Its first product is the Acetronics programmable video game and the first computers will follow later this year.

Industrial interfaces

BELGIAN COMPUTER manufacturer, Data Applications International, have launched a new 'personal' computer with a range of over 20 industrial control interface cards. The company hopes to by-pass the need for custom-built interfaces for industrial applications.

According to Data Applications (UK) Ltd, the computer is, in all other respects, very similar to the Apple, even though the DAI Personal Computer is based on the Intel 8080. The system can grow from 8K to 48K of ROM and has 24K of ROM (Basic). Prices range from £500 to £1000.

Data Applications (UK) Ltd, which has been formed to market and support the microcomputer, is based at 16B Dyer Street, Cirencester, Gloucestershire, GL7 2PF, tel: (0285) 2588.

Heath turns on the heat

A MORE AGGRESSIVE line in marketing is planned for Heath Electronics by its new parent organization, the Zenith Radio Corporation. A new marketing company, Heath Electronics (UK) Ltd, has already been established for the Heathkit, the Zenith Data Systems range of assembled microcomputers and computer peripherals (previously Heath Data Systems) and the Heath education courses.

Managing director of the new company is David Taylor, formerly international marketing manager of the Telequipment Division of Tektronic. The company is based in Bristol Road, Gloucester, GL2 6EE. Tel: 0452 29451.

Exponential market

THE SEMICONDUCTOR market in Europe is expected to grow by over 10 per cent by the end of 1980, predicts a recent survey.

This compares with a nine per cent expansion in the US and 12 per cent in Japan. These figures reveal semi-conductors as a boom area, for the gross national product of Western Europe is expected to increase by only 2.4 per cent in that time and to decline by about half a percent in the UK.

The survey, by Motorola's market research people, also compares the sums of money spent in various markets per head of the population.

The Japanese spend over \$24, the USA \$20, while Europe lags a long way behind with \$7.5.

In the Western European countries, West Germany sets the pace with \$18.3 per head, the UK \$11 and France \$8.7. These proportions work out very similarly when calculated as a percentage of GNP.

To make matters worse we can expect growing Japanese influence on our TV sector during the year, with the likelihood that some Japanese companies will establish bases here to offset possible trade embargoes. And, unlike the rest of the world, Britain is unlikely to incorporate semiconductors, into what is left of its car industry, fast enough to complete effectively.

The language debate

YOUR NOVEMBER EDITORIAL was clearly intended to stimulate discussion concerning the suitability of different languages for programming microprocessor systems.

Before pronouncing a language to be suitable or otherwise, one should bear in mind who the user (the programmer) is. Your readership presumably includes the first-time user (probably a small businessman), the hobbyist who may be more interested in hardware than software — or vice-versa, the enthusiastic full-time programmer who is becoming more skilful by the microsecond, and even a few academics.

Each of these individuals has different expectations of his hardware, his software, and his own programming abilities. Moreover, these expectations will change as they gain experience. So whereas it is true that one rarely hears of Basic programmers sighing for the more powerful Pascal (just as a few years ago one never heard Assembler programmers sighing for Basic), so one never hears those who have really used Pascal longing for the "good old days" of basic, or those who have learnt Basic reversing to Assembler (unless it is to write device handlers or to compensate for a slow interpreter).

As one learns to use three or four languages, one learns to appreciate that each has a role. We should remember that the acronym Basic stands for "Beginners' All-purpose Symbolic Instruction Code", and that is why it is so popular with first-time users. Since it is often the only alternative to Assembler, it is understandable that experienced programmers also use it, as the figures you quoted show. However, your figures only indicate what languages people used — they said nothing about how many were able to choose from a selection — how many were using Hobson's choice?

I would be interested to see a similar set of figures published each year, distinguishing between hobbyists and business users, as more people discover that the true cost of software is not in getting the Mark I version of one program to work after a fashion, but in getting several programs to work together reliably over months and years, keeping them up to date and growing to meet changing specifications. And not by one person, but by a succession of programmers who must be able to comprehend what their predecessors have done. Those readers who have experience of program maintenance will know what I mean!

David R. Gibby,
Fleet, Aldershot,
Hants.

Pascal proponent

IN YOUR NOVEMBER editorial you invited your readership to comment on the relative merits of Pascal and Basic. I find that I must side with Pascal, and I suspect that many others with experience of both languages would agree with me.

You say that everyone admits the most serious disadvantages of Pascal is the difficulty of learning it. I agree that Pascal is syntactically more complex, but I would suggest that in learning one's first computer language, the main problem is getting to grips with the programming concept, and in fact Pascal tries to emphasise just this in its syntax.

The superior data structures and control constructs may seem daunting at first, but nobody jumps in at the deep end, and I am sure

that a subset of Pascal with a direct analogue in Basic would not be significantly more difficult for the beginner to grasp. There is no need for a beginner to use the more sophisticated aspects of Pascal at first, but it would seem sensible to start programming in a language in which they exist already, rather than having to change language if the need arose.

You do not seem to have a very high opinion of computer science academics, nor with their belief that any hard work expended in learning Pascal is imposed not by the language but by the principles of clear thought which it embodies. To me the whole point and beauty of Pascal is that it embodies these principles.

Even at the simplest level, Pascal is geared towards readable and reliable programs and the problems of producing reliable business packages on micros illustrates the usefulness of this. At the higher level, such things as tree structuring, which would be a headache in Basic, are dealt with quite naturally in Pascal.

So, in conclusion, I maintain that Pascal is quite capable of catering for both the beginner and the advanced programmer.

Ian Glendinning,
Crumpsall,
Manchester 8.

Limited Basic

A MAJOR HANDICAP to programming on micros is that there is a present no language suitable for amateur micro users.

The most readily available and most used language is Basic. To many users, especially those who have never used a high-level language before, Basic may seem like God's gift to computing but it has some serious limitations.

The first of these is it has no major data structures other than arrays and subroutines, and routines are of a very limited nature. And although Basic itself was designed to be an interpreted language (which is a great advantage to the amateur) it was developed from Fortran which is a language designed for batch use.

As a result it is difficult to write elegant and clear programs in Basic. This can lead to all sorts of debugging problems. Basic's other main disadvantage is that it is too simple to allow the programmer to use the full power of his micro.

The fact that Basic is so simple has, however, been one of the main reasons why it has been so successful, but as more users become less concerned with hardware and more with software, they will begin to demand more powerful languages. Micro firms are, I think, now becoming aware of this. One of the indications of this is the recent introduction of Pascal to micros.

Pascal itself has its own disadvantages and although it certainly has a much richer supply of data structures (ie record) it suffers from being a language far more suited to larger machines.

This is reflected in the size of the Pascal compiler (Pascal is a language far more suited to be compiled than interpreted). As a result I cannot see many amateurs using Pascal and those that do must have more memory than sense.

A better language to implement would be Lisp. But even Lisp has its disadvantages and is rather wasteful in the amount of memory it uses. I think a far better solution would be to

develop a language designed to be run on small micro systems and the sooner this is done the better.

Even if you do not agree with any of the above, I hope it will enable you to start to think about the software situation. It seems to me that micro users are usually more concerned with the hardware than the software of their systems and the sooner this situation is reversed, the better it will be for all.

G. Hart,
University of Essex,
Colchester.

Adaptable Pascal

AS A PROGRAMMER, I would like to comment on a few points raised in the November editorial on languages. Surely, for the personal computer user (or any programmer) the most important feature of Pascal is not its elegance, compactness or speed of execution, but that you can write substantial programs more easily and quickly than in Basic.

The programs are likely to have fewer bugs and be far more readily understood by others (also by the author, when modifying them a month later).

The degree of standardisation is another attraction. Programs can be moved from mainframes to 8080s and then run perfectly with no modification.

There are Tiny Basics, Scientific Basics, Business Basics . . . If you are going to go to all the trouble of making Basic into a universal language (even Pascal is proving difficult to standardise fully) is it not better to start afresh with a more suitable language?

Is Pascal so difficult to learn or use? Like anything else it can be learned gradually, starting with programs as simple as:

```
begin  
  write ('Hi everybody')  
end.
```

Just type R to run and apart from a slight pause for compilation (done automatically on the first run) it's exactly like learning Basic.

It did not take long for Basic to make an impact on the personal computer market and with Pascal's growing popularity in industry and teaching, the proportion of *Practical Computing* readers who use it can only increase.

True, Pascal has neither the generality nor the interpretive style of Lisp. I would be the first to concede that Lisp is a superb language — one of the most exciting yet devised. It is an essential tool for Artificial Intelligence, but not for most other programs the personal computer user is likely to write, including systems programs.

I have found that the simplicity of Lisp's syntax can be a positive hindrance to understanding, let alone debugging programs.

Hours can be spent counting parentheses and drawing pictures of lists. After all, when a language will allow you to write almost anything, it cannot tell you so easily if you are doing something wrong!

In conclusion, I feel that there is plenty of room for Pascal alongside Lisp (and Basic) as a valuable programming standard. There has certainly been a large priority placed on producing a Pascal for market leaders such as Apple and TI computers. Has the vote already been cast?

Keith Frewin,
TCL Software,
London N.W.1.

The Dream Machine

I ENJOY reading *Practical Computing* and purchase nearly every issue. The Buyers Guide is very useful, but an addition could be useful. My other hobby is hi-fi. Here separates are known to be better for many reasons as well as that you can start from a basic system.

I see microcomputers in the same light. A section on VDU, printer terminals, printers, floppy discs and other storage devices would be useful, even if you printed only one extra section per month. When I find the right set-up I will buy a computer of my own, until then I will 'borrow' computer time.

The set-up as I see it is as follows:—

VDU: 132 x 30 lines; user-specified characters, multi-lingual, graphics, plitter, mathematics and Greek, full upper and lower case, printer interface (something like those from DELTA and LOGICA).

Printer: 7 x 9 dot matrix, 150-180 cps, capable of printing all the VDU characters.

Printer terminal: Daisywheel 55cps, typeface to include Greek, maths, plotting, formulae, graphics etc. Friction feed for single documents, pin-feed, 12 characters per in (eg Qume from Access Data Communications).

"Computer" central processor: Basic, Pascal, Algol 68, Fortran, Graphics, colour, games. 64K with units to 512K. Two terminals, cassette, floppy disk, disc drives, interfaces.

Graph plotter: Four colours. For starting, 64K processor with the VDU.

This system would cost about £4000 (I think). So far I have not found the computer that can be built up like that.

**Gerald McMullon,
Manor Park,
London E.12.**

Mr McMullon's ideas sounds a good one, but it does raise the dread question of compatibility. Organising the information to cope with it might be difficult. But anyway: that's his ideal system — have any readers other ideas? Why not let us know about them? — Ed.

Teenage triple threat

FIRSTLY I would like to say how much I enjoy *Practical Computing*, and I think that it is certainly the most interesting and well put-together magazine on this subject, and it has improved even more since it was taken over by IPC Business Press (*Honestly, I never met this man in my life!* — Ed.).

I do not have a computer, but I have access to an ITT 2020, a PET, an ICL 19045 Computer and a CDC Mainframe (the last two through my school). I know Basic, Fortran, Plan, Logo, and 6502 machine code programming and have been computing for three years.

I am writing regarding Trevor Lusty's AI Noughts and Crosses program. Two readers suggested some improvements. However both seemed to be under the impression that L8 is a string array, when in fact it is a string variable of three bytes.

Thus K. Lundy's suggestion for line 3660 is incorrect; the original line 3660 should work. Also Mr Lundy's line 2340 seems to have been misprinted. I have not entered the program, but when I looked through it, I noticed a mistake in line 2340, and amended it to read:
2340 LET T2 = T2 + T1 * (10 (2*(3-N)))
which should work.

Also in the section to decide who starts, I

have changed it so that M7 is either 0/, 1 or 2 (0 M7 2), otherwise M7 increases by one every game, which after many games would cause memory problems. I have also changed line 1540 so that the computer can move first when starting the first game. The INT (RND(0) *2) chooses either 0 or 1, although for different Basics the RND function gives different effects:

```
1540 LET M7 = INT (RND(0) *2)
1860 IF M7 = 1 THEN 1880
1870 LET M7 = 0
1875 GOTO 2280
```

I have also changed the program so that you can choose whether or not to play again if you draw to win, but as this may not be of any use to some people, I have not written it here. However if you would like to stop a game at any time by typing "—999" in your turn, add:

```
1901 IF H = —999 THEN 3080
(1481 PRINT "TO STOP IN A GAME
TYPE '—999' IN YOUR TURN")
```

**B. M. Graham (age 15),
Chigwell,
Essex, IG7 5QS.**

Inchbald's defence

We had this letter from reader Andrew Bardsley:

HAVING READ Mr Inchbald's article 'Getting to grips with the MK-14' (p84 Dec '79) I have a feeling he is not very enthusiastic about this kit.

As I am considering buying my first kit, I would be grateful for his views on the best buy around this price.

I am only 15 years old and still a student and therefore cannot afford to waste my money on a kit such as the MK-14 which sounds to me totally unreliable.

I read your book every month and find it most interesting though it would be even more interesting if I had a computer and could program in the great programs from your book.

It is my intention to take a degree in computer science.

**Andrew Bardsley,
Swinton, Malton,
N. Yorks.**

Guy Inchbald replied:

I AM SORRY to have given you a bad impression of the Mk 14.

Microcomputers are complicated beasts, and unless everything is just so they are apt to go bananas. They are also fiddly things to assemble, and however well-designed, a kit is only as reliable as its builder. My article was aimed mainly at the inexperienced newcomer to electronics, and as such is full of warnings to the unwary. But this is no reflection on the basic Kit, which is as good as any other.

The Mk 14 is well-suited to electronics hobbyists who want a cheap introduction to microprocessors. If your main interest is confined to programming, the Newbear 77-68 and Acorn I are more expensive, but more easily expanded later. Remember, you get what you pay for.

And if computers take over your head, your wallet and your soul, then you'll be just like the rest of us.

Backchat

THE FOLLOWING ROUTINE is useful for brightening up interactive sessions:

```
10 PRINT "HI THERE! HOW'S
THINGS";
20 INPUT A$
30 FOR I = 1 TO 7
40 READ B$
50 IF POS (A$,B$) 0 THEN 70
60 NEXT I
70 IF I 3 THEN 110
80 IF I = 6 THEN 130
90 PRINT "NO COMMENT!!"
100 GOTO 180
110 PRINT "DON'T WORRY, THEY'LL
GET WORSE!!"
120 GOTO 180
130 PRINT "GLAD TO HEAR IT!!";
140 PRINT "ALL YOUR NEED IS A
SYSTEMS CRASH!"
150 GOTO 180
160 DATA BAD, TERRIBLE, RUBBISH
170 DATA OK, GREAT, SUPER, XYZ
180 RESTORE
190 . . . . .
```

Not as flexible as the MATCH statement in PILOT, perhaps, but it demonstrates the usefulness of POS in BASIC for detecting unspecified input.

This kind of routine can be useful for teaching purposes, giving the pupil the opportunity of responding to a question without the usual prompting by an MCQ. If no match is found then an MCQ could be supplied. If B\$ is read to an array, to ensure that each complete set of DATA items is read in turn, then with suitable replies (also read from DATA statements), this type of routine could be nested as a GOSUB, needing only an extended DATA set to be powerful and flexible.

**Dr. Barry Clark,
Department of Biochemistry,
Western Infirmary,
Glasgow G11 6WT.**

A Dutch conspiracy?

AFTER READING the letter in your December issue from Mr Van Lew, I thought that if a computer had 1 memory for each line of win, then added —1 if its move was in the line and +1 if your move was in the line, then when the line total was +2, there would be a threat; conversely if the total was —2, then the computer could win the next move. If the line is ade up of +1, —1, and +1, the total is +1, so there is no longer a threat.

The only computing capability I have is a T.I. 57 and so can not use this idea but I thought that Mr van Lew, and others, may be interested.

**Nicko van Someren (age 12),
Bottisham, Cambs.**

Mind-fodder for the captives!

AN INMATE writes to us from Ford Open Prison to say that many of his fellows are very interested in micro-computing and although they can't get their hands on any hardware, they would be very grateful for second-hand manuals, and text-books. Send them to *Practical Computing* marked 'Prison'.

Recording variables

AS A NEWCOMER to the computing game using a UK101 I have met two difficulties for which I cannot find good solutions.

How can I record on tape the values of the variables and strings as calculated by the program? I have been using rather a weird method. If each statement such as "X=" is preceded by a "spurious" line number in "", out of range of those in the program, the tape recorder will be fooled into thinking these are program lines. Hence they may be taped and played back into the computer.

I find that if I run the recorder while executing the program in slow motion on SAVE, I can get out a picture of the format, with variables as entered.

I can find no enlightenment on these points, and feel there must be better ways . . .

Since there is no assembler for the UK101 — I don't know about its relation, the Ohio Superboard — I would have to write I/O routines in machine code. Although I have a chart of the codes, and a 6502 book by Rodney Zaks, I'm not getting on very well, and ask if you have in the past published a more gentle approach. Anyway Zaks speaks as if everyone had an assembler program.

I should like to thank you belatedly for "Zombie", which is very amusing for children, especially since one can get from the extensive UK101 graphics some realistic potholes and sufficiently terrifying Zombies.

R. J. Newman,
Chesham, Bucks.

● A friendly voice at **Comp Computer Components** recommends that you use a machine code subroutine to dump the contents of memory to tape. This will automatically include all the variables and their pointers, flags and general gubbins. To speed things up, you could find out where the program was in memory and not bother to dump that, since it won't change.

The alternative, the voice went on with slightly less assurance, is use the Monitor subroutine at **FCB1** which loads a byte from the Accumulator to tape. Naturally they have to load the good news into the Accumulator first, using the appropriate machine code instructions.

We intend to start a series soon on writing machine code and assembler which may be some help. Otherwise, the cheering word is that it's hard work, but fearfully good for the soul!

School troubles

I ALWAYS FIND the technical brilliance of the various microcomputers described in the text or advertisements very fascinating. I am able to dream of the many applications I could find for such hardware in the school science department where I teach — simple data retrieval, pupil self-test programmes, programmed learning, and so on.

At the polytechnic which is encouraging my research into the application of a micro-computer program to a particular part of a school science curriculum, I am able to use a system. What I am not able to do is actually to get a real, live, and working microcomputer in my classroom.

Considering the plethora and the cheapness of such units, I find this difficult to understand, considering all we hear about the impact of such technology on children in the near future. What I want is not to talk, theorise, and speculate, but to have a microcomputer *now*, switched on, in the classroom, with the kids using it.

The school is short of money and the effect of cuts and expenditure are thwarting the best efforts of the L.E.A. science adviser. This is all happening at a time when children are being told about the effect of computers on their society.

Can anyone help?

Malcolm C. Barker,
Baynham Court Farm,
Wick, nr. Dursley,
Glos.

. . . and a success!

LAST YEAR, just after Christmas, I wrote a letter to your Feedback column concerning the purchase of a computer for my school. In the letter I received from *PC's* former editor Mr Jarrett, I read of the many possibilities of raising money and he told me to "keep in touch" and "gave me the best of luck".

Well, fortunately, that luck came, and a few weeks ago the school obtained a Horizon computer with one disk drive and 32K of RAM. Now I am learning Basic extremely fast and so are all the other members of the computer club. We have begun to write many programs for the Horizon and I am now very happy and content.

Thank you for printing my last letter, and I am now told that because of its appearance in your magazine it was a form of prompt, indeed we have got far more than I would have expected.

R. J. Fiddick,
3 Hannafore Lane,
Cornwall, PL13 2DT.

Any answers?

THIS DEPARTMENT is carrying out a survey into the development of microprocessors and their applications in the community, with particular reference to the ways in which this new technology will assist the disabled and in education.

Our aim, in brief, is to collate all available literature and documentation from research bodies, manufacturers and suppliers, in order to produce a catalogue of materials available.

We should be pleased to hear from any of your readers who feel they may have a relevant contribution to make to our survey, and ask them to contact us at the Department of Mathematics and Computer Studies, Sunderland Polytechnic.

Mrs. J. Winton,
Sunderland Polytechnic,
Green Terrace,
Sunderland SR1 3SD.

Micros in the library

WE ARE beginning research the possible applications for microcomputers in special libraries and information units. As a preliminary to our investigation we would like to establish the exact state of the art of such applications in this country.

By utilising the personal contacts of the members of this division, we have already been able to gather a few names, but further information would help us tremendously.

R. P. Winfield,
Aslib,
London SW1.

Poetry corner

THIS LITTLE GEM appeared in Feedback's mailbag. Is this the start of a new age of enlightenment?

The Hierarchy of Power Semantics

In the beginning was the Plan and the Specification.
And the Plan was without form and the Specification it was void.
And darkness was on the face of the implementation team.
And they spake unto their leader, saying,
"It is a crock of shit and it stinks to high heaven."

And it was the leader and it was the project head.
Now the leader spake unto the project head, saying,
"It is a crock of faeces and intolerably malodorous."

And it was the project head and it was the department manager.
Now the project head spake unto his department manager, saying,
"It is a container of excrement and its effluvium is very strong."

And it was the department manager and it was the product manager.
Now the department manager spake unto his product manager, saying,
"It is a vessel of fertilizer of overpowering strength."

And it was the product manager and it was the centre manager.
Now the product manager spake unto his centre manager, saying,
"It containeth that which aideth the growth of plants and strong it is."

And it was the centre manager and it was the director.
Now the centre manager spake unto his director, saying,
"It promoteth growth and it is very powerful."

And it was the director and it was the vice-president.
Now the director spake unto his vice-president, saying,
"This powerful new product will promote the growth of the Company."

And the vice president looked on the product and saw that it was good.

All Systems Are Not Created Equal

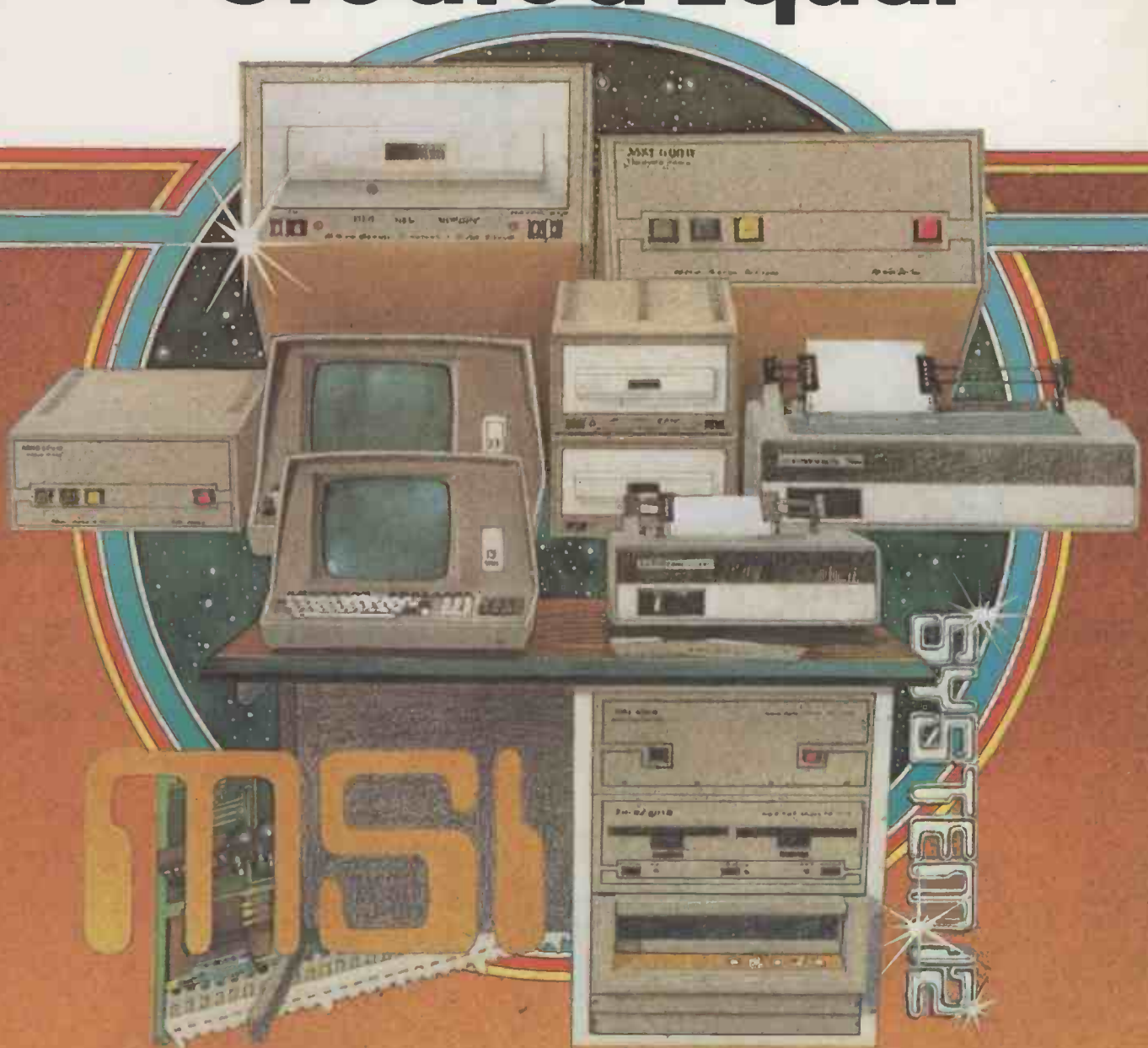

Your computer application is unique. It differs from all others. It is because not all applications are equal that MSI has developed a variety of computer systems.

At the heart of every MSI System is the powerful MSI 6800 Computer, one of the fastest and most versatile available. Depending on the System you select, the MSI 6800 has from 16K to 56K of RAM. Mass memory storage in MSI Systems range from 315K bytes in the System 1 to over 76 megabytes in our most powerful System 76.

In addition to the computer and memory subsystem, MSI Systems include a CRT terminal and high speed character printer. The System 12 and 76 are housed in a compact desk unit.

As with hardware, computer software is not always created equal. Since there are a myriad of programs available, MSI offers a choice of Operating Systems for use with your MSI Computer System. Of course, our favorite is MSIDOS, but we offer the powerful SDOS and FLEX operating systems as well. All MSI Systems will support the other software products associated with each operating system.

MSI also has a variety of software programs including a complete Accounting Package and a Multi-User Basic program capable of supporting up to four users.

MSI Systems are currently being used in a broad spectrum of personal, scientific, educational, professional, industrial

control, and business situations. In addition to our Systems, MSI can supply you with individual components for personal and OEM use. All MSI System components are available, some in kit form.

Write or call us for more information about MSI Systems and products and the name of your nearest MSI dealer.

seed

STRUMECH

PORTLAND HOUSE, COPPICE SIDE
BROWNHILLS, WEST MIDLANDS

TELEPHONE: BROWNHILLS 4321

Moving data at a snail's pace because you're floppy bound?

At last, a fast mass disk storage system for your micro-computer. The new CORVUS 10 megabyte hard disk lets your programs run faster and access more data than ever previously possible.

"How do I use it?"

If you have an Apple¹, Tandy², North Star³ or LSI-11 system, you can just plug in and go, just like any of your other peripherals. All the interfaces have been designed and tested to work with your existing software, all of which means that there is no new disk operating system to learn. Your programs will run virtually without modification!

"What about back-up copies?"

The unique Corvus MIRROR system allows you to dump onto any video tape recorder. Data is transferred at 1Mb per minute. Advanced error checking algorithms ensure a truly secure system.

"Just how fast is it?"

Normally your disk accessing speed will be about 20 times quicker than with using floppies.

"Fixed disks are bulky though aren't they?"

Not this one. New technology has provided 10 million bytes of storage space in less than two-thirds of a cubic foot of space!

REMEMBER: ALL EXISTING APPLICATIONS WILL RUN WITH LITTLE OR NO MODIFICATION.

The Sales Ledger that was just too large for the floppy system can now be handled with ease. The sorting of 10,000 names and addresses is possible in a short space of time. Stock Control of large inventories can be handled quickly and efficiently.

The serious business user cannot afford to be without one!

1 Pascal and DOS versions
2 TRS-80
3-or any other \$100 bus micro



Corvus disk with interface	£3500
Corvus add on disk	£2500
MIRROR interface	£500

CORVUS SYSTEMS, Inc.

Keen Computers

Exclusive distributor. Retail enquiries welcome.

Keen Computers
5b the Poultry, Nottingham
tel: 0602 583254
telex: 37297 (keenco)



Minimax makes the most of user program space

by Jim Wood

A NEW ADDITION to the ever-growing range of microcomputers available in this country is the Minimax II, marketed in the UK by ACT of Birmingham.

ACT are the sole agents for the British Isles and aim to provide a system both as stand-alone machines and as an alternative for those PET users who run out of processor power and disc storage. There are seven regional dealers and ACT are expecting to announce shortly a new agreement with a major High Street electrical retailer (Currys) involving both the Pet and Minimax.

Equipment

The Minimax is a complete diskette-based video computer system built around a 6502 microprocessor running at 2MHz. The system has 106KBytes of semi-conductor memory, of which 45KBytes are available as program RAM.

The remainder of the memory is split between a resident monitor with TINY assembler, ROM-based MDOS operating system, a Microsoft Basic interpreter, a basic Fifth interpreter and I/O registers.

The disc drive used is the Computhink PET compatible twin mini floppy drive, available with either 5in or 8in floppy diskettes. The diskettes are double-sided double-density, giving a formatted storage capacity of 400KBytes for a 5in diskette and 1.2MBytes for the 8in diskette.



The system provided for review comprised the standard Minimax and an 8in dual, double-sided, double-density drive. Putting the system together proved simple: just plug in to two 13-amp sockets, connect the disc drive and turn on. The Minimax has a separate on/off switch located at the side of the screen; the drive is turned on at the mains. There is a multi-strand flat cable to connect the drive to the computer.

If the drive connector cable is plugged

in upside-down (quite easy to do), both drive lights come on when the Minimax is turned on. This useful hint is mentioned right at front of the well-written user's guide.

Turning the system on takes the user into the Microsoft Basic interpreter and displays the available program memory, 46079 bytes.

Apart from the disc connection, there is an RS232 serial port and a standard parallel printer port, implemented with an Intel 8255 programmable peripheral interface. All are well-marked and easily accessible at the back of the machine.

Keyboard

The keyboard is arranged with a standard QWERTY layout and has three separate keypads. The left-hand keypad has a set of eight punctuation characters. Those to the right are a standard numeric keypad and eight separate cursor manipulation keys, including cursor up, down, right, left, clear screen and delete character.

The layout of the keyboard is rather spoilt by having the two RETURN keys unseparated on either side of the space bar and the two shift keys above them. Coupled with a cramped keyboard, this tended to increase the number of accidental RETURNS.

There is a shift/lock key, which has a small red light which shows when the key

continued over page

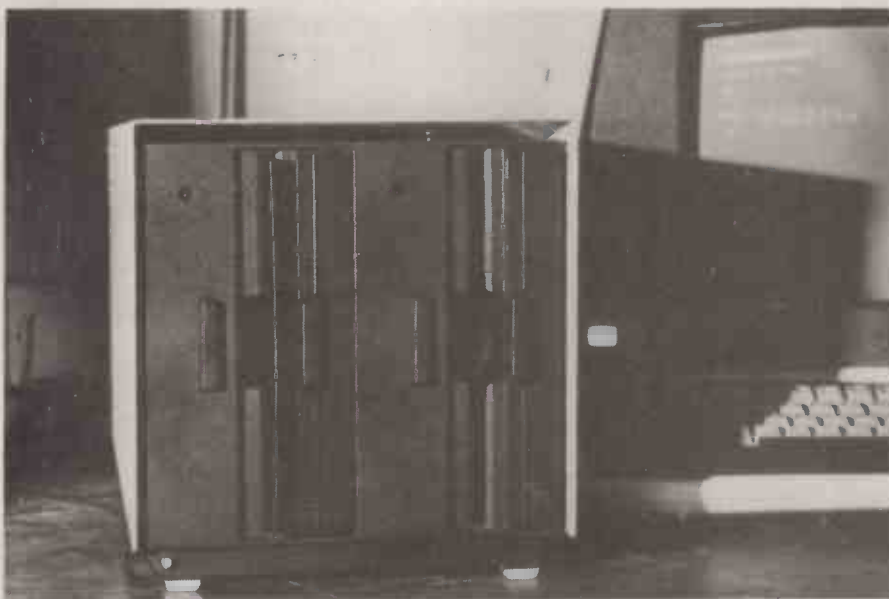

From previous page

is depressed and locked and enables the user to change the function of 63 keys to 63 Pet-style graphics characters. The keyboard has no lower-case alphabetic characters.

Display

The display provides 30 lines of 64 characters and incorporates a rectangular flashing cursor. The cursor does not flash on and off but appears continuously to roll over, giving a whiff of sea-sickness if one concentrates on the screen for any length of time.

The character representation is adequate when using normal white on black, but with reverse video, a very low screen brightness is needed to avoid some characters being swamped by the white background; it was rather difficult to arrive at an acceptable compromise.

When the Minimax is turned on, the screen is set into a locked-page mode of operation and it is necessary to use a POKE command to enable scrolling. Unfortunately this command is buried deep in the programmer's Technical Manual and does not appear in the Beginner's Guide.

The display can be used for high-resolution graphics and provides 122880 addressable points in 240 rows by 512 columns. The graphics commands are provided with the Basic interpreter, thus avoiding the direct use of PEEK and POKE statements.

But I have several major criticisms of the display screen and its use. The screen facia, which is plastic and is stuck on, tended to fall off at inappropriate moments. This is rather cheap and nasty considering the price of the system.

There is no direct cursor addressing available in the Basic — it is necessary to print a string containing the required

sequence of screen-control keys. The Basic interpreter does recognise a quote followed by a cursor key as having a separate function, for instance having a statement with a clear screen in quotes will not effect a screen clear while the keys are being hit.

This seems to be a rather cumbersome approach to providing cursor addressing and tends to impose rather larger programs than would be expected otherwise.

When entering in page mode, it is necessary to list a screen clear once the bottom line of the screen has been used. If this is not done, a subsequent bottom-screen line that is shorter than the previous one will be found to contain all the remaining characters, regardless of the use of the RETURN key. This is particularly annoying as the Basic interpreter-only syntax checks statement lines on entry in Command (or Immediate) Mode.

The final criticism is the lack of a true delete key. To remove an erroneously typed character, it is necessary to back the cursor down the line and use the delete key to delete forwards.

These criticisms must be weighed against the ability to edit a section of code either by retyping a new line (as is common in most Basics) or by using the cursor control keys to achieve page editing, in a similar fashion to some text or word processors.

This does away with the requirement for some of the Basic functions that would be available in an editor, which is just as well since no editor is provided.

Disks

The system treats each side of a floppy diskette as a separate drive unit, giving four drives for a standard system. Formatting a diskette takes about 20 secs and

is surprisingly noisy. One minor criticism — which applies to many other micros as well — is the lack of an error message when trying to address or format an empty drive; this system hands and has to be reset.

The transfer rate is quoted as 15,000 characters per second, but we were unable to verify this as all the diskettes provided for the review were software right protected. The system provides a fairly fast disc directory look-up which indicates file names and sizes (by tracks).

Two major restrictions that are apparent in the file-handling side of this Basic — we think they are caused by MDOS — is that it is possible to have only one program file open at any one time and second the fact that you are not allowed to write beyond the initially declared size of a write sequential data file.

This combination will place severe restrictions on the ease of programming for commercial usage and must impose an overhead on any multiple file-handling applications.

Microsoft Basic

The Basic provided is a resident Microsoft Basic interpreter which proved to be one of the better versions of Basic that we have looked at, even allowing for a number of minor quibbles.

Plus points

- Points we liked about the Basic were:
 - True string arrays
 - Multi-dimensioned arrays (up to 225 dimensions, but the screen will effectively limit this to 26)
 - Multiple statement lines
 - A line number range up to 63999
 - SET and RESET graphics statements
 - The ability to call assembly language subroutines
 - Shorthand PRINT character — '?'
 - Dynamically defined arrays
 - CETC, V — this statements get the ASC II value of the reset key depression and places it in the named variable
 - Separate variable names and storage for integers and floating-point numbers
 - 962 variable names for each of string, integer and floating point, can have A, AA and A1
 - Can load and run a new program directly
 - Full range of mathematical and algebraic functions, including a number that are not normally provided
 - On screen statement editing, the Basic is fairly straightforward to use and is definitely helped by the Beginner's Guide, which takes a step-by-step approach to mastering the system.

Minus points

- Our major criticisms are these:
 - No syntax checking on entering statements
 - One file only open at any time

MINIMAX II (ACT 824)

ACT dealers

Scotland: ROBOX
 North-West: Stack Computers (Lincoln)
 North-East: No dealer at present
 East Midlands/East Anglia: HB Computers (Kettering)
 West Midlands: Taylor Wilson (Birmingham)
 South: PETALECT (Woking)
 London: Micro Computer Centre

Prices

These prices were quoted by ACT and are exclusive of VAT.

Hardware

ACT 808 (£3450): Minimax II, Computhink 8in twin mini floppy drive with 2.4M bytes.
ACT 816 (£4500): as 808 but with second 5in drive, total 1.6M bytes.
ACT 824 (£4450): Minimax II, Computhink 8in twin mini floppy drive with 2.4M bytes.
ACT 848 (£6000): as 824 but with second

8in drive, total 4.8M bytes.
 Centronics printers — from £950.

Software: (all disc-based)

Languages:
 Extended Assembler
 Extended Fifth PLM (Algol-like) prices on application
 Fortran
 Pascal
 MLI compiler
Application:
 PET Sales Ledger, Purchaser Ledger
 Invoicing: prices on application

Fully integrated sales order processing, stock, purchase and nominal ledgers, payroll and word processing available in the New Year.

Memory breakdown (in HEX)

0 — 400
 Resident Monitor (with TINY assembler)
 401 — B7FF Program RAM (45K bytes)
 B800 — BFFF Fifth Interpreter
 C000 — E1A9 Microsoft Basic Interpreter
 E1AA — FFC0 MDOS
 FFC1 — FFFF I/O registers

Practical Computing evaluation

	Yes/No NA	1	2	3	4	5		Yes/No N/A	1	2	3	4	5
Ease of construction (where applicable)	N/A						Assembly language					●	
Quality of documentation						●	Basic language					●	
Dealer support/maintenance				●			Other languages	YES					
Can handle 32K of memory	YES						Compatibility with other systems					●	
Quality of video monitor (consider resolution and screen size)					●		Reputation of manufacturer	N/K					
SS-50 Bus	N/A						Appearance				●		
S-100 Bus	N/A						Portability					●	
Sockets for chips	NO						No. of software applications packages available			●			
Numeric, calculator-type pad on keyboard	YES						Hobby use				●		
Large amount of removable memory, randomly accessible	YES						Business use					●	
Cassette tape recorder capability: Own	NO						Educational use				●		
Built-in recorder	NO						Suitability for Commercial applications					●	
Floppy disc capability	YES						Home applications					●	
Communications capability	YES						Educational applications					●	
Speed of instruction cycle	2mHz						Ability to add printer(s)	NO					
Ease of expansion	N/A						Ability to add discs	YES					
Lower power consumption				●			Ability to add other manufacturers' plug-in memory	NO					
							Ratings 1 = poor; 2 = fair; 3 = average; 4 = good; 5 = excellent. N/A = not applicable.						

- A single direct input buffer from file, for instance if you: INPUT\$, A\$ and then INPUT\$, B\$ will overwrite A\$. It is necessary to write:
INPUT\$, A\$
A\$ = A\$
INPUT\$, B\$
B\$ = B\$
This moves A\$ and B\$ out of the buffer into memory.

- There is no PRINT USING statement
- All spaces are automatically removed when a line is entered and then displayed
- The cursor disappears when listing a program and RETURN must be hit before it comes back
- A program may be listed in its entirety or from a specified line number to the end only
- The number of records in a data file must be a multiple of 21 and the number of characters in a record must be a multiple of 60 — thus the smallest file size is 1260 characters.

Manuals

The system documentation consists of a Beginner's Guide, a programmer's Technical Manual, a list of disc errors and instructions for using and attaching a printer. All are well-written and fairly easy to follow, the above criticism expected.

The Beginner's Guide will certainly get someone started on the system with a minimum of fuss and the Technical Guide is very comprehensive, covering Basic, assembler usage, Fifth and detail on the machine operation.

Further systems and expansion

The system comes complete with a TINY assembler and a language called Fifth. Fifth is a simple register-to-stack register assembly language, and uses 84 operation codes. One particular improvement over similar languages is the fact that the op-codes are defined as strings of up to seven characters in length as opposed to having numeric op-codes. The language is designed to be portable. The system also has 64 microprogrammable op-codes and is designed to recognise all 6502 microprocessor op-codes.

The memory on the system is not yet expandable. Both Fifth and the assembler are provided on disc in an extended form, along with Fortran, Pascal and PLM (an Algol-like language), but none of these was provided for review.

Speed and software

The system seems relatively fast. A simple benchmark, the loop FOR I = To 10000 takes 7½ seconds, which is 3½ times faster than a TANDY TRS-80 and

between 2½ and 3 times faster than a PET. ACT will provide the PET-based Sales and Purchase Ledgers and Invoicing to run on the Minimax and the system will support files written for PET on the Computhink drives. Finally, the screen may be split into individual sections and referenced directly through the 8K RAM video memory.

Conclusions

● **Minimax is a fast worthwhile upgrade to an existing PET system with Computhink drives. The Basic tends to be better than most currently available systems, even allowing for the obvious criticisms; an extra plus is its ability to call assembly language subroutines.**

● **From a Basic system of 800Kbytes, the disc storage can be extended up to 4.8Mbytes. The system is fairly easy to use and the documentation easy to follow.**

● **It provides a larger user program space, greater than most comparable systems.**

● **The restrictions on file opening and extension will make commercial use difficult.**

● **At this price for a Basic system, the Minimax is moving well out of the personal computer market.**

● **The memory system can be extended.**

● **The screen and keyboard are in some instances poor for a system of this price.**

The ten commands: will they change your life?

There's no need to step through fire to bring the tablets down from Sinai. John James takes a sceptical look at ten (or is it nine?) new add-on machine-code subroutines for the PET, holds them nervously in the palm of his hand, and concludes they may change your life, too.

WHAT EXACTLY is the Basic Programmer's Toolkit? Well, answering physically, it'll depend on whether you have an 'old' or 'new' PET. And how do you tell? If you have one of the small keyboards, then for our purposes you have an 'old' PET; a big keyboard (and therefore a separate tape cassette unit), and you have a 'new' PET.

The only effect this has on the Toolkit is on the type of Toolkit you get.

For an 'old' PET, you get a small printed circuit board, with a chip and some other bits mounted on it, and a connector loose-wired to its edge. The board has another connector mounted directly on it, which lets it be plugged straight into the memory expansion board port on the right-hand side of your PET. The loose-wired connector is then plugged into the second cassette port, just round the corner, at the back.

For a 'new' PET, you simply get a chip. This you take in nervous fingers (try holding a chip that cost over sixty quid, and see if you aren't nervous), to plug straight into an empty socket on the main board inside your PET.

Obviously, installation on an 'old' PET couldn't be easier, so there's no point in covering the question 'can you do it simply?'. Fitting a 'new' PET sounds a bit more tricky, so how hard is it?

Nothing could be more straightforward, thanks to one of the best instruction books I've seen in many a day. If you follow the book, you really can't go wrong. It's worth saying here, for the knowledgeable, that the book also covers all the things you'd expect, like avoiding static discharge, bent pins, and so on. In other words, fitting should be no problem at all — except if you've had expansion memory fitted to your PET. Here, the book recommends that you 'contact your dealer for installation information'.

Now there is room for criticism here, since you won't be reading the book until after you've got your Toolkit. Have you ever bought a super-gadget-gizmo, hurried home in high excitement, torn the wrapper off, and then found you hadn't got the necessary battery because nobody said you'd need one? Familiar with the frustration this causes?

Then be warned. If you have got expansion memory, tell your dealer at the

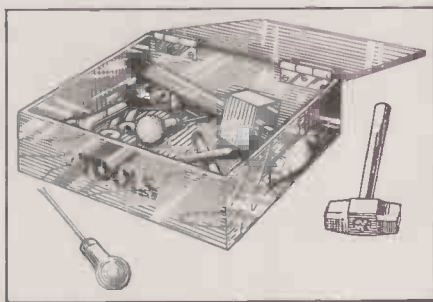

time of buying, and make sure that he can advise you.

Once you've fitted the Basic Programmer's Toolkit, what will it do? Here, I'd like to come back briefly to the instruction book that comes with the Toolkit. It's 34 pages long, nicely printed, totally explicit, clear as crystal, loaded with example programs, and best of all, originally written by Gregory Yob.

The cognoscenti will have twitched at that magic name; others should know that Gregory has not only been in personal computing since Heaven knows when — to many, he *is* personal computing.

This means that you'll get the best out of the Toolkit right from the word 'go', and the best can mean quite a lot. Yet there is room for another criticism. The Toolkit is widely advertised as adding '10 powerful new commands to PET's Basic', which I think is not entirely fair.

In fact, you get nine new commands (we'll have a look at how powerful they are in a moment); the tenth isn't really a command, in my view, since it simply switches off a couple of the other nine.

So what are these nine powerful commands? The best way of answering that is to look at them one by one, but before we do that, let's return to that magic moment just after you've fitted Toolkit, and you're about to start trying it out.

You have to turn it on, and this you do very simply by entering SYS 45056. PET should respond immediately by displaying (C) 1979 PAICS.

From that point on, all nine active commands are available until you switch PET off. You get them back, after powering down, by entering the SYS instruction again.

Reviewing the nine commands gives me a choice: I can tell you about them alphabetically, or in order of personal favouritism, and I'm going to opt for the latter.

Let's start with RENUMBER.

Now this one is really good (not that the others aren't, but I said I'd start with my favourite!). The major point to make immediately is that RENUMBER is fully professional.

In other words, forget about those previous methods, using add-on subroutines, which required you to go right through the program, looking for line numbers, to make sure each one had enough space before it for whatever it might become when renumbered.

The Toolkit RENUMBER expands or contracts line numbers, and closes everything else on the program line up tight to the new number, whatever it might turn out to be.

You activate RENUMBER by typing the word and entering it. If you do this, Toolkit assumes you want to start at Line 100 and go in steps of 10.

If you want to start at any other line number, and/or go in other increments, you simply say so and it happens — and pretty fast too. I linked four programs together, all about 6K long, and renumbered the lot in less than 15 seconds.

Of course, it depends on the number of renumbers (if you get my meaning), but you shouldn't have any complaints about the time you hang about.

There are two other goodies in RENUMBER.

First, if renumbering will take your line numbers over the maximum permitted, the routine aborts, and no renumbering takes place. You'll like that if you've ever 'crashed' with other methods!

Second, if the routine comes across a line number that doesn't exist later in the program (as in GOTO X, and X isn't there, for instance) then it quite deliberately renumbers that to 63999.

This ties in nicely with my next most-liked command, FIND.

FIND locates all lines that contain absolutely anything you like to specify. It's important to be clear about this, because the advertising for Toolkit isn't. The advertisements say that FIND locates

Now you can control your business for less than £2,500.

This could be your best investment opportunity yet. A complete computerised business system, including a Floppy Disk Unit, high-speed Printer and *Britain's best selling microcomputer* – the Commodore PET. All for under £2,500.

First Class Programs

A comprehensive range of first class programs is offered by *Commodore 'Business Software' Dealers*. These are available on disk from £50-£500. And they cover such applications as *Business Information, Stock Control, Word Processing, Payroll, Accounting and Mailing Systems*.

Service and Support

With over 10,000 PET computers installed in the UK, dealer support is growing fast. A nationwide network of 90 official

Commodore 'Business Software' Dealers ensures that service and technical facilities are close to every PET user. Our dealers can even offer you a 24 hour on-site maintenance agreement.

Training and Instruction

The PET Business System is self-contained and simple to use. Should you require personalised programs or extensive installation training this can be arranged with your *Commodore 'Business Software' Dealer* who can also give details of official *Commodore Training Courses*. These include intensive 2 & 3 day workshops to train you to write your own programs.

For full details about the Commodore PET Business System, Training Courses, Programs, and *'Business Software' Dealers*, simply fill in the coupon and post today.



To: Commodore Information Centre,
360 Euston Road, London NW1 3BL

Please send me details of the PET Computer Business Systems.

Name _____

Position _____

Company _____

Address _____

Tel. No. _____

If you have a particular application in mind please specify:

P.C.B.I.

commodore
We made small computers big business.

lines 'containing a desired character string'. That's quite true, but it's misleading, in that you might well think that all you can ask FIND to do is look for strings.

Not so. FIND will do much more than that (which certainly means the advertisements err on the right side!). FIND will find anything. If you want to know which lines have the variable 'G' in them, and you enter FIND G, then every line with the variable in it will be found and displayed.

Note that FIND G won't find GOTO or GOSUB, just because they have a 'G' in them, which saves a lot of confusion. To find GOTO statements, you need to enter FIND GOTO, and the same holds good for any other Basic statement. If, on the other hand, you enter FIND "G", then every quoted string that contains the letter G, whether it's on its own or contained in a word, will be found and displayed, which is not only useful, but fun.

Now you'll see the point of renumbering non-existent lines to 63999. All you need to do to find them is enter FIND 63999, and presto! there they all are, displayed for your pleasure. And, what's more, you can then go right ahead and edit them on screen, which helps resolve little local difficulties quite quickly.

Keeps on adding

I think my third favourite must be APPEND. This one adds program to program to program, for just as long as you have memory available to keep doing it. You only have to keep one thing in mind: APPEND does not replace program lines in memory with new similarly-numbered lines from the material you're appending, not does it interleave program lines. Quite simply, it does exactly what it says: it keeps on adding program lines to the end of whatever might already be in memory.

It does this from tape only, however, and will not append from disk or other devices. I don't see this as a very great disadvantage, but perhaps some people will.

All I can say is that I've already found the command incredibly useful, in only a few days of playing about. If I have a favourite subroutine or whatever on disk, I don't really feel it's a great hardship to off-load on to cassette so that I can use the APPEND facility.

My fourth favourite? Well, we're getting to the photo-finish stage now, but maybe a whisker or so in front is HELP. You use this when that lovely point comes, as you finish typing the world's finest program, which of course is totally error-free, and run it, when everything judders to a standstill halfway through, with PET beadily blinking ERROR at you.

You look at the line allegedly in error, and it seems perfect, just like the rest of the program.

Fret not; if you'd like to know where

that little but is lurking, enter HELP. Up comes the line again, but this time a bit of it will be in reverse field. This, says the manual, is where the error is. Well, I found this wasn't strictly true, but it was close enough to make no difference. Sometimes the reverse field is to the left or right of the error, sometimes a character or so distant, but it's never far away. After all, if the error was something missing, it'd be hard to put a reverse field on what wasn't there!

Mounting panic

The fifth and sixth commands are similar: TRACE and STEP. Both put a little reverse-field window on the top right-hand corner of the screen, which displays up to six line numbers. With TRACE, the program runs steadily, and the line numbers being executed whip up the little window at a high rate of knots.

The manual says that TRACE slows the running of a program considerably, and that pressing the shift key slows it still more, to around two lines per second. Even at that, though, it's still moving fast, and I haven't so far found TRACE overpoweringly useful. The only effect it's had on me to date is to induce a mounting panic as I tried to keep up with what was happening. These are early days, though.

STEP seems rather more sensible, but to be harsh, it's merely an extension of TRACE, in that it displays one line number only, and that's the one that's just been executed.

For debugging, my vote goes to STEP, however. Not that my programs ever have bugs in them, of course, but I can always offer my help to those less fortunate!

One smart thing about both TRACE and STEP: the reverse-field window overrides any screen display, which avoids peering at line numbers through over-written screen characters. This is a disadvantage too though, because it's possible (but, to be fair, odds-on unlikely) that a bug you're trying to spot will be right under that little window!

DUMP comes next, and I have a feeling that I'm going to love it more and more. You use it most often at the end of a program, and entering it causes every single variable (excepting arrays) to be printed, with the value each has at that time.

Now I'm a messy programmer: in other words, I like to program straight on to the screen. Not for me the clean, aseptic approach of writing everything out beforehand.

Thus I often get to a point where I'm uncertain which variables I've used, which I haven't, and what values I've given those that I have put in. I'm sure that you, gentle reader, never do this, but just in case there's someone out there who does, DUMP could be exactly what he or she needs.

Family resemblance

The final two commands — AUTO and DELETE — have a family resemblance

also. Their names explain virtually all. AUTO provides automatic line numbering, in whatever increments your heart desires, as you type furiously through your program-entering process. DELETE wipes whole blocks of lines out, between whatever numbers you specify.

That, at least must save wear and tear on the Return key but, ironically enough, the other commands available in Toolkit tend to lessen the usefulness of DELETE for me. I'd have loved it in those not-so-far-off days when I used subroutines tacked temporarily on to the front or rear of the main program.

And there it is: the Basic Programmer's Toolkit, with 2K of ROM firmware, consisting of a collection of machine language routines, all on one chip, adding nine (or 10, if you want to be finicky) new commands to your PET.

Is it worth £60? I would say yes.

Petsoft tell us:

- They are writing a British annexe to the Minimax manual with the intention of 'making a number of contributions aimed at the naive user.'

- This business software, available for the PET on Computhink mini-floppies, has been adapted and integrated for the Minimax. This means that programs from the suite can be run without having to 'bust through a series of complicated disc-to-disc steps.'

- Software titles which will be available early in the new year are Sales Accounting and Invoicing, Purchase Accounting, Stock Control, Word Processing and before the new financial year, Payroll.

Petsoft are also publishing a range of 50 utilities, languages and simple business routines. During the course of the year Petsoft will release some graphics packages supporting animated graphics, 3D plotting and a "small-talk" type package.

The CPU, in addition to recognising all standard 6502 instructions, will also support 64 user programmable op codes. These can be used for Pascal and Forth operations.

CompuThink themselves have Pascal, a compiled Basic and Fortran under development for release early in 1980.

Conclusions

- It's added a lot more fun to my programming
- It's made bugs much easier to find
- It's encouraged me to be a little more adventurous in trying out different methods, because I know, if they're not right, I'll be able to locate them and change them
- Maybe best of all, it has let me go back to half-finished programs from long ago, and tackle them again.
- Toolkit also makes conversion of old-ROM programs very much more simple.
- If you're any sort of 'hacker', what are you waiting for?

“If you want what’s best for your PET, choose Commodore software.”



Kit Spencer
General Manager
of Commodore Systems
360 Euston Road
London NW1 3BL

The Commodore PET is Britain’s best selling micro-computer, with over 10,000 already installed in a wide range of fields, including Education, Business, Science and Industry.

This has led to a tremendous demand for high quality software.

And Commodore has met this demand by producing a first class range of programs, now available from the nationwide network of Commodore Dealers.

Commodore’s support also includes training courses, a Users’ Newsletter and Official Approval for compatible products of other manufacturers who reach agreed standards.

COMMODORE PETPACS

Over 50 Petpacs of programs are available (mainly on cassette) from Commodore Dealers.

These cover such popular titles as Strathclyde Tutorial, Statistics pack 1, Assembler Development System, Stock Market Trends and the Treasure Trove Collection of game packs including the award winning Star Trek, which is packaged with Petopoly. Prices are from £5 to £50.

TRAINING COURSES AND SEMINARS

PET systems are simple to use and any normal advice or assistance

NEW BUSINESS SOFTWARE PROGRAMS ON DISK

Commodore’s Floppy Disk Unit and high-speed Printer, combine with the PET to form a complete system (ideal for running a business) for under £2,500.

Commodore also produce a growing range of business software on disk available from Official Business Software Dealers.

Business Information System – COMBIS £150 + VAT

Combis facilitates the storage and instant retrieval of all kinds of company records, from personnel files to mailing lists and printed address labels.

Stock Control – COMSTOCK £150 + VAT

Comstock provides an accurate, up-to-the-second and comprehensive stock position for as many as 1,300 products.

Word Processor – COMWORD £75 + VAT

Comword turns the system into an excellent word processor.

Payroll – COMPAY £150 + VAT

Compay is a new, comprehensive payroll package.



you may need can be obtained from Commodore Dealers.

On the other hand, for rapid training on a basic or advanced level, you will certainly be interested in Commodore’s intensive 2 and 3 day residential courses. We also run one day general appreciation seminars.

PET USERS’ NEWSLETTER

This is Commodore’s official method of sharing new information and ideas between the many thousands of PET users. The newsletter is published regularly and for an annual subscription of £10 you can start receiving copies now.



Look out for this sign. It tells you that compatible products of other manufacturers have met with our standards of approval.



(Tick the appropriate boxes)

To: Commodore Information Centre, 360 Euston Road, London NW1 3BL 01-388 5702

I am a PET owner Please put me in touch with my nearest dealer
Please send me details of: Commodore PET Software
Training Courses & Seminars I would like to receive the Users’
Newsletter and enclose £10 annual subscription

Name _____ P.C.S.1.

Address _____

Tel. No. _____

commodore
We made small computers big business.

Genie's missing magic

Your wish is my command — but only up to a point. We assess the first complete micro package offered in the UK.

VIDEO GENIE is the cheapest get-up-and-go microcomputer completely packaged with full facilities and adequate memory so far offered in the U.K. It is fully-compatible with one of the three most popular existing micros in its class, so there is no shortage of instantly-available software.

Essentially it is an all-in-one improvement of the Tandy TRS-80 Level II 16K. The Genie case includes the keyboard, integral cassette player, and both video and UHF modulator outputs. The price is £425 including VAT, compared to the official Tandy recently-discounted offering at nearly £600 which, however, includes a video monitor. Even if you manage to secure one of the keyboard-only deals — you supply your own cassette, TV and power supply unit (psu) — at £150 plus VAT the Genie is attractive. A year ago the TRS-80 Level II 16K would have cost £807.

At this price, should one be criticising at all? I think so. The micro is not longer a novelty and while the earliest models on the market were entitled to a tolerant reception, each new entrant has to offer better value than its predecessors if it wishes to survive.

Better value in this context is not only a matter of pricing; the public will look also for reliability, freedom for clearly-avoidable design mistakes and first-rate documentation.

In many respects the Video Genie is an improvement on the TRS-80 but a number of irritating features remain. It is also not entirely clear for whom it is intended — small business, education, hobbyist; the Tandy answer to that has always been 'All three' and the manufacturers of the Video Genie say the same.

Overall, the package is neat and portable. There is a minimum of trailing wires and even two hooks at the back to store flex not required immediately. The construction is semi-modular.

The keyboard is well-spaced and features 'roll-over'; I doubt, however, whether it is tough enough for day-in-day-out usage. My clumsy fingers found stuttering easy.

The cassette player is to the right of the keyboard. That has certain advantages for the beginner but might be a nuisance once interest has progressed to the point where discs are added; at that stage the cassette drive merely occupies space which could perhaps have been given to a separate numeric pad. There are provisions for a second cassette player controlled via a



DIN socket at the back; the lead is supplied.

There are some curious design decisions, though. The power, re-set, video-cut—32-character half-page option for use with a poor monitor — are all located at the back of the box, though the special key (PAGE) to select which half you view is on the front. Another key (F1) de-activates the 'remote' on the cassette interface so that Fast Forward and Rewind can be actuated without the jack-plug juggling necessary on the TRS-80. If you use the second cassette player you are back to all the fiddling.

All those problems could have been solved by clearly-marked keys on the front of the case; in fact, when you remove the ABS outer case — a kind of straw colour with pseudo wood end-pieces — you find that the keyboard holder appears to have spare locations which are not in use.

One control all too familiar to TRS-80 owners, the cassette volume pot, is absent. Video Genie claims to have solved the problem of automatic gain control, so that the model is now in line with what all manufacturers, apart from Tandy, seem to have been able to achieve.

The claim is justified, except in one respect. Because of the CLOADing problems on the TRS-80, packages available from various software houses catering for the Tandy vary in their volume setting. There is an even greater variety in the setting adopted by home software programmers.

The Video Genie automatic gain control appears to be insufficiently flexible to cope with everything. I picked up a clutch of software from the office from some of the most prolific commercial outlets and a few cassettes from readers. Many of them failed to CLOAD properly, the VDU reporting SN (syntax Error) or UL (undefined line) which, on closer examination, showed that loading had stopped before completion.

After uncasing the machine and removing the cassette drive to examine the board below, I identified the variable resistor which needed tweaking. If I pushed it too far, I could not CSAVE and CLOAD. The pot is clearly not designed for much more than initial alignment and the occasional attention during services, and it would not be wise to fiddle with it too often. So, whether there is some inherent fault in the Genie, which I doubt, or whether it is suffering from the legacy of TRS-80 problems, a semi-accessible volume control is essential if advantage is to be taken of all the available TRS-80 software; it would be easy to provide.

The strengths and faults of the TRS-80 remain. There is no direct cursor control, which is attractive for beginners, but you have to type-in EDIT, at which point various subcommands — insert, hack and insert, cancel and re-start, change, become available on pressing the right single key. The trouble is that they take a time to learn and must be understood before you can do much in the way of writing your own programs.

**AUTHORISED
PET
COMMODORE
DEALERS**

Birmingham

Camden Electronics
021-773-8240

CPS (Data Systems) Ltd
021-707-3866

Taylor Wilson Systems Ltd
Knowle 05645-6192

Bolton

B & B Consultants
0204-26644

Bournemouth

Stage One Computers
0202-23570

Bradford

Ackroyd Typewriter &
Adding Machine Co
0274-31835

Brentwood

Direct Data Marketing Ltd
0277-229379

Bristol

Bristol Computer Centre
0272-23430

Sumlock Tabdown Ltd
0272-26685

Cambridge

Cambridge Computer Store
0223-68155

Cardiff

Sigma Systems Ltd
0222-21515

Colchester

Dataview Ltd
0206-78811

Derby

Davidson Richards (Int) Ltd
0332-366803

Durham

Dyson Instruments
0385-66937

Edinburgh

Micro Centre
031-225-2022

Exeter

A.C. Systems
0392-71718

Grimsby

Allen Computers
0472-40568

Hemel Hempstead

Data Efficiency Ltd
0442-57137

Hove

Amplicon Electronics
0273-720716

Leeds

Holdene Ltd
0532-459459

Liverpool

Aughton Automation
051-548-6060

Cortex Computer Centre

051-263-5783

Dams Office Equipment

051-227-3301

London E2

Ragnarok Electronic Systems
01-981-2748

London EC1

Sumlock Bondain Ltd
01-253-2447

THE PET



**Britain's no.1
micro-computer
from**

 **commodore systems**

**the complete system
full range of peripherals
nation-wide dealer
sales and service**

**In case of difficulty contact
COMMODORE SYSTEMS DIVISION
360 Euston Road, London. Tel: 01-388-5702**

**AUTHORISED
PET
COMMODORE
DEALERS**

London N14

Micro Computation
01-882-5104

London NW4

Da Vinci Computers
01-202-9630

London SW14

Micro Computer Centre
01-876-6609

London W5

Adda Computers
01-579-5845

London WC1

Euro Calc Ltd
01-405-3113

London WC2

TLC World Trading Ltd
01-839-3893

Manchester

Cytek (UK) Ltd
061-832-7604

Executive Reprographic

061-228-1637

Sumlock Electronic Services

061-834-4233

Matlock

Low Electronics
0629-2817

Morley, W. Yorks

Yorkshire Electronic Services
0532-522181

Norwich

Sumlock Bondain
0603-26259

Nottingham

Beros (Systems) Ltd
0602 48106

Oxford

Orchard Electronics
0491-35529

Plymouth

JAD Integrated Services
0752-62616

Preston

Preston Computer Centre
0772-57684

Reading

CSE Computers
0734-61492

Southampton

Business Electronics
0703-738248

Symtec Ltd

0703-37731

Xitan Systems

0703-38740

Sunderland

Tripont Associated Systems
0783-73310

Woking

P.P.M. Ltd
Brookwood 04867-80111

Pelaleet Ltd

04862-69032

Yeovil

Computerbits
0935-26522

North Scotland

Thistle Computers
Kirkwall 0856-3140

Northern Ireland

Medical & Scientific
Lisburn 08462-77533

• Circle No. 185

Not all the facilities are useful; e.g., nD tells the computer to delete n characters to the right of the cursor, so that you don't have to space-bar your way through and you don't appear to have the one thing which would be helpful, the opportunity to delete three characters, say, and replace them with five.

Compared to the Pet and Apple — and a number of other machines — the graphics are fairly limited. You can locate a character anywhere on the screen with ease, but essentially you are limited to bars, asterisks, brackets and punctuation marks. You can have histograms but graphs are a trifle tiresome. Also, there is no built-in lower-case character set.

There is a standard modification for the TRS-80 to accomplish this, as the Z-80 cpu has no problems with handling such a facility if the appropriate character generator is hooked-in; it would be handy clearly in such applications as word processing, to which Tandy Basic adapts easily.

In addition to the DIN socket for the second cassette, there is a S100 bus which could go on to an expander board for hooking-up discs, printers, modems, and whatever. All the Tandy add-ons should work. The Video Genie importers, Lowe of Matlock, hopes to provide its own semi-dedicated add-ons. I understand that there will be a colour card soon.

I was supplied with a loose-leaf folder as the manual had not been printed at the

time I received the review machine. Video Genie seems to be leaning heavily on the Tandy Level II Basic Reference Manual.

Tandy assumes you have worked through Level I — with its justly-famed idiot-proof manual — and that you approach the senior machine with some knowledge of Basic. If the Video Genie is your first machine, the lists of functions will not be much help. Further, because Tandy/Genie Basic is slightly different from Microsoft Basic, it is not much use suggesting to novices that they work with one of the standard guides like *Illustrating Basic*. No general book, for example, will help with the simple problems of line editing, which are so often discouraging to the beginner.

Again, a number of the commands are obtained in a slightly unusual manner, picked-up easily by the experienced programmer but confusing to the individual who thought he could be writing and running programs within an hour of unpacking the machine.

There is also a demo cassette which has some simple graphics, some very obvious statistical programs, a biorhythm calculator, and the inevitable space game.

The importers, Lowe Electronics, one of the biggest importers of Japanese amateur radio equipment have an excellent reputation among hams. It claims to turn round most repair jobs within 24 hours and that half of its staff is concerned with servicing as opposed to

selling. It tells us that part of the deal to take the Video Genie from Hongkong is a guarantee of necessary spares.

Conclusions

- By present-day prices the Video Genie is welcome and, as a general-purpose micro, is good value.
- The compatibility with the Tandy TRS-80 means that there is already a substantial body of software available.
- The machine is tough enough for home use but probably would not take persistent pounding in a small business or educational application.
- Expansion should be relatively easy, using add-ons from a variety of sources.
- Some attention to minor items of detail, the placing of switches, and the provision of a volume control is needed. It would require little thought to accomplish this oneself, but doing it neatly might be another matter.
- We do not regard the TRS-80 Basic as the easiest with which to start, though its good qualities appear a little later.
- The documentation is satisfactory for programmers with some experience but needs smartening if the machine is to make a big impact on first-time buyers.

Video Genie is imported by Lowe Electronics, Matlock. Only the 16K model will be imported to the U.K. through a 4K version is also made. Price £425 including VAT.

Practical Computing evaluation

	Yes/No N/A	1	2	3	4	5
Ease of construction (where applicable)	N/A					
Quality of documentation					●	
Dealer support/maintenance				●		
Can handle 32K of memory				●		
Quality of video monitor (consider resolution and screen size)	N/A					
SS-50 Bus	N					
S-100 Bus	Y					
Sockets for chips	N					
Numeric, calculator-type pad on keyboard	N					
Large amount of removable memory, randomly accessible	Y					
Cassette tape recorder capability: Own	Y					
Built-in recorder	Y					
Floppy disc capability	Y					
Communications capability (can talk to other computers)	Y					
Speed of instruction cycle	?					
Ease of expansion					●	
Lower power consumption					●	

	Yes/No N/A	1	2	3	4	5
Assembly languages	Y					
Basic language	Y					
Other languages	N					
Compatibility with other systems	TRS-80					
Reputation of manufacturer	NEW					
Appearance					●	
Portability					●	
No. of software applications packages available						●
Hobby use						●
Business use						●
Educational use						●
Suitability for Commercial applications						●
Home applications						●
Educations applications						
Ability to add printer(s)	Y					
Ability to add discs	Y					
Ability to add other manufacturers' plug-in memory	N					

Ratings

1 = poor; 2 = fair; 3 = average; 4 = good; 5 = excellent. N/A = not applicable.

Get the answers before you get the problems

The Willis Catalogue of computer supplies is a complete range of products to meet the requirements of computer users.





We include flexible discs, cassettes, cartridges, storage equipment and filing systems, ribbons and labels.

A full range and first class back up service means you can check the Willis Catalogue first for all your needs.

For your copy of our latest catalogue Phone Bishops Stortford (0279) 506491 or send coupon.

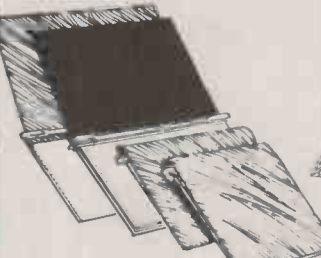
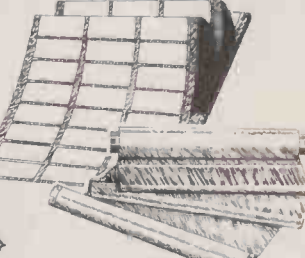
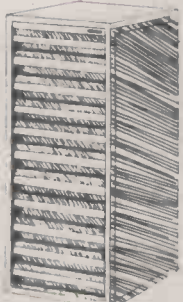

WILLIS
Computer Supplies,
for people who know better

 <p>Flexible disk and storage</p>	 <p>Cartridge disk and cleaner</p>	 <p>Stationery binders</p>	 <p>Ribbons and labels</p>
 <p>Disk cabinets</p>	 <p>Printwheels and W.P. Ribbons</p>	<p>To: Willis Computer Supplies Ltd., P.O. Box 10 Southmill Road, Bishops Stortford, Herts. CM23 3DN Please send me your 1979 Catalogue.</p> <p>Name _____</p> <p>Company Address _____</p> <p>_____</p> <p>_____</p>	

• Circle No. 186

Personal computer networks: better than the next best thing to being there.

Home brewed computer networks may be changing the American way of life. As a preview of what may happen to us, we present a recent survey from the West Coast magazine *CoEvolution Quarterly* by Art Kleiner and Willy Davis.

ONE OF THE EARLIEST and most powerful computer dreams, the home electronic information and mail network, is now becoming available to the public in America. Unlike other countries, where telecommunications systems are often centralized, twenty or more separate systems are operating or plan to begin soon in the US.

Their sponsors range from AT&T, Xerox and Warner Communications to the National Science Foundation and Corporation for Public Broadcasting to grass-roots groups of computer hobbyists. Some computer networks were set up to experiment with the possibilities of the medium; others are limited forms of electronic text aimed at businesses or personal computer owners; still others will compete commercially for the chance to become the next Bell Telephone system.

The recent development of cheap terminals made the dream economically viable. Video-display terminals, most looking like video screens with keyboards, have become available for \$500, and are expected to become cheaper. "Smart" terminals, or microcomputers, are generally not much more expensive.

From the horse's mouth

THE AUTHORS are writing magazine articles/ masters' theses about how people are using two-way telecommunications systems. If you have firsthand observations or anecdotes, contact them at 4106 Emerald Avenue, Oakland, CA 94609 or 415 653 7710. They collect such items as these from Art:

"Eighty-five percent of the people who go to public access computer facilities are kids, 8-18 years old. There are a lot of teenagers around who are brilliant, creative programmers; they start computer consulting firms or get jobs with software companies. A 17-year-old manages the ARPA-NET hookup at Lawrence Berkeley Labs. At the Marin Computer Centre kids are afraid of obviously outclassing adults, so they deliberately play their computing talents down when their parents are around.

"CRT terminals are potentially dangerous

sources of X-ray radiation and eye damage. This may not sound like news; but a National Institute for Occupational Safety and Health study in 1977 said computer programmers were safe from radiation. Now, the FDA (or a medical researcher at the FDA) told me they're not satisfied with the way NIOSH tested the machines. CRT terminals are especially dangerous sources of radiation because you peer into them at close range for hours at a time.

The communications workers (San Francisco Communications Workers Union: an example of alliance between labor and anti-radiation people), are investigating eyestrain and eye damage now because of complaints from Directory Assistance operators, who have to scan through all those numbers on the terminals. Researching this subject makes me absolutely delighted to be a computer typesetter."

Three principal applications of XTEN are shown in this cutaway. Document distribution: Sending and receiving terminals and work stations can be linked because of the network's compatibility. Advanced printing devices at mail distribution centres (left) allow rapid delivery. Data transmission: From interactive terminals (lower centre), data can be sent and received on request. Remote job-entry terminals can utilize broadband service to permit high-speed input/output operations. Processors and files can be located to the customer's choice. Teleconferencing: Conferences (right) will include high-quality, still-frame video, hard copies on demand and voice capability.

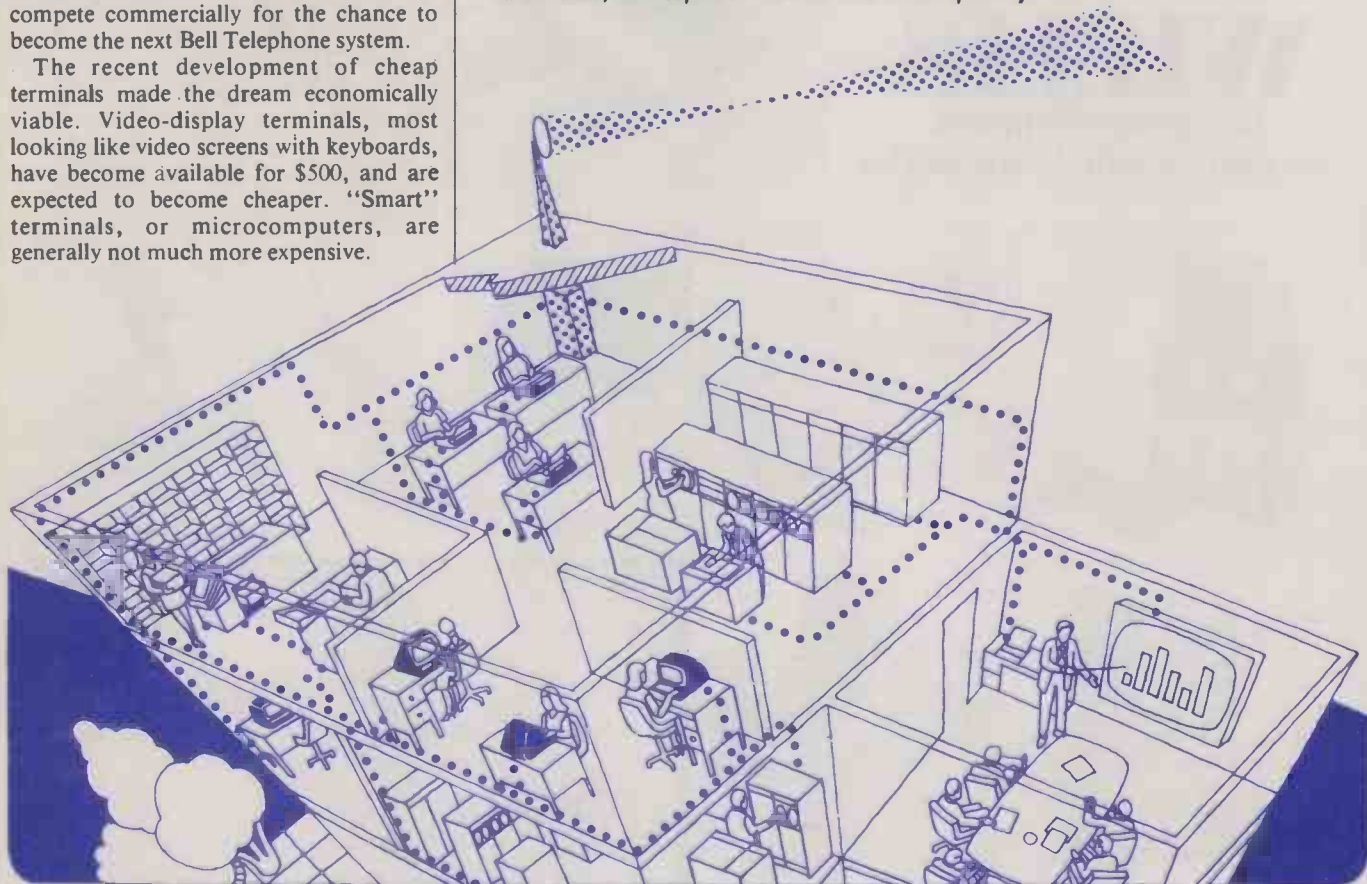

Terminals translate typed-in-words (and pictured input in a variety of ways) into binary code, which can then be transmitted over telephone lines, wire cables, fiber-optic cable or broadcast waves. The cost is often less than that of long-distance phone service.

Some of the most promising uses include news services edited by computer to people's personal needs; elaborate computer-aided fantasy games played with others through the system; computer conferencing; instant mail; and immediate access to groups of people or libraries of words and film, which are found by specific combinations of keywords. The possibilities were described more elaborately by Gene Youngblood and Paul Baran in the Winter, 1977 (Broadcast) issue of *CQ*.

As some of these networks evolve into versions of Youngblood's National Information Utility, the political questions are still unanswered:

- Who controls the networks?
- Must they be centralized?
- Who has access to them?
- How are their contents chosen?
- How are they paid for?
- What technology is used to transmit messages?
- What services are offered?
- How do users interact with the system?
- What provisions exist for privacy?
- How to get in touch?

This is *not* an exhaustive survey, but it should give some idea of the range of the leading contenders, plus some influential experiments.

QUBE. Columbus, Ohio; may soon be introduced to Boston and Pittsburgh. Started December, 1977. Sponsored by Warner Communications Corp. Contact: Leo Murray, V.P. Public Affairs, 75 Rockefeller Plaza, New York, NY 10019.

This widely-publicized, two-way cable TV station offers normal cable TV, pay TV and potentially interactive local channels. On interactive shows, viewers push yes/no/

multiple choice buttons to respond to opinion polls or order products after commercials.

A central computer monitors each TV set every 6-10 seconds, recording responses and what channel the set is tuned to. The system is used for political polls, talent shows, university extension course exams, and commercials with built-in market research that seem to serve Qube's sponsors better than its subscribers.

Warner's research showed people wanted the simplest system possible — hence the limited amount of interaction. "Mrs Jones doesn't want to take the time to learn to be a computer expert," spokesman Leo Murray said. Qube warns viewers in advance when their responses are recorded, and does not release records without subscribers' consent, he said.

They expect to introduce video games, security systems and electronic funds transfer directly from subscribers' bank accounts to stores. March 1979 articles in *Atlantic* and *Penthouse* go into more detail.

Last October over 3000 sets were tuned in to QUBE in Columbus to discourse on food labelling with Donald Kennedy, then head of the Food and Drug Administration. Kennedy was surprised at some of the results: more than half the audience wanted ingredients listed by percentage rather than weight; 70% wanted more nutrients added to foods; only 15% understood metric measures (Kennedy expected 40%).

To connect you need: a TV, \$19.95 one-time installation charge, and \$10.95 monthly rental. Pay-TV programs average \$1-\$4 each.

VIEWDATA. A British consumer system, available sometimes in 1979 in America as a business service. Sponsored by Insac Viewdata, Inc, a subsidiary of the British National Enterprise Board.

Viewdata is a type of interactive text system developed by Insac and operated by the British Post Office under the name Prestel. A Prestel terminal is an adapted TV set with a telephone connection and a remote-control switch-box that looks like a pocket calculator.

Viewers press numbers to call for pages of travel information, business information, retail advertising, or constantly updated news. Pages appear on the screen in bright colours and block letters; each page includes a list of 10 other pages that can be called up for more information, like a cross between a library and a chain letter.

Sometimes people must go through seven or eight pages to reach the one they want. News agencies and advertisers pay the British Post Office for the opportunity to put their messages on the air.

To connect, British viewers need an adapted TV (\$30-\$50 more than a regular TV); plus the price of a phone call. Each page carries a charge, usually 1¢-4¢.

Several companies will offer variations on Viewdata in America.

Insac, the parent company, will not offer the service publicly, but hopes to find businesses or broadcast stations that will establish closed Viewdata systems for their members or clients. These groups will make all the decisions about what information to use, how to present it and how much to charge. For more information: Martin Lippman, VP, 277 Park Avenue, New York, NY 10017.

The Knight-Ridder newspaper chain will test a home Viewdata system in Miami beginning in 1980, spending about \$1.3m to do so. Contact: Viewdata Corporation of America, One Herald Plaza, Miami, FL 33101.

KSL-TV, Salt Lake City, has an experimental demonstration system now; a public system is subject to FCC approval. Service is at least two or three years away. Contact: Bill Lovelace, Director of Engineering, 145 Social Hall Avenue, Salt Lake City, Utah, 84111 "Station owner Arch Manson went to London," Lovelace said, "came back and said, 'Why can't we do that?'"

Texas Instruments would manufacture terminals costing \$30 more than a normal TV if a million are sold.

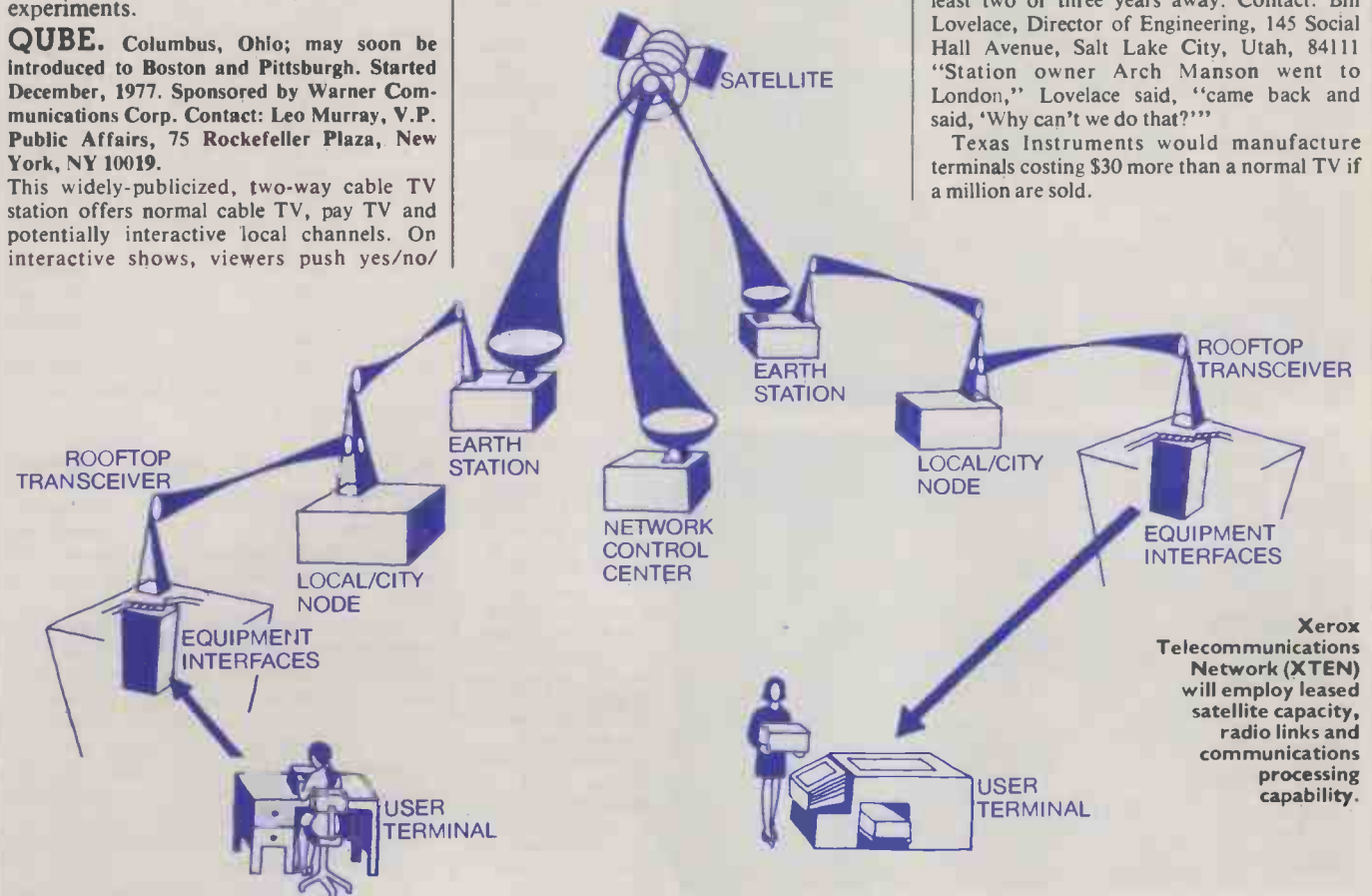

Xerox Telecommunications Network (XTEN) will employ leased satellite capacity, radio links and communications processing capability.

```
TO: 6975622
WE ARE GOING OFF THE AIR TO DEMO
SOME OTHER NETS - BACK UP IN 50
MIN OR SO.
MSG # 8 94 CHARS
```

```
MODE? (N=NO, I=IMMED, D=DEFER)
I
```

```
22:03:02
XMT MSG 8
6 9 7 5 6 2 2
CARRIER
```

```
GOT @P06 AT 220333
SENT
```

```
MSG # 8 KILLED 94 CHAR FREED
22:03:58
```

There are a number of computer bulletin boards in US cities where home computer owners can leave and take messages. Dave calls one in San Diego.

```
DATE ----> 04/19/79 TIME ----> 100000
000
```

```
CBBS/SAN DIEGO IS TEMPORARILY OFF-LINE (
OHN)
DUE TO A BAD STEPPER MOTOR IN THE DISK D
IVE
AS SOON AS I GET THE MONEY TO FIX THE DR
IVE
THE SYSTEM WILL BE BACK ON-LINE.
```

```
WOULD YOU LIKE TO DONATE $10 OR MORE (Y/
N)? N
```

```
TYPE "G" TO EXIT (HANG UP, LEAVE SYSTEM)
: 1*GBUM?
```

```
THANK YOU FOR CALLING.
OFF HMM?
```

... and one in Chicago which is working ...

```
TYPE (C/R)
TYPE (C/R)
WELCOME TO THE COMPUTER MERCHANTS ABBS
```

```
WHAT IS YOUR FIRST NAME ?
REENTER
```

```
?DAVE
WHAT IS YOUR LAST NAME ?CAULKINS
WHERE ARE YOU CALLING FROM
(CITY, STATE) ?LOS ALTOS, CA
WHAT IS YOUR PHONE NUMBER
(XXX-XXX-XXXX) ?415-948-1474
```

```
HELLO DAVE CAULKINS FROM LOS ALTOS, CA
HAVE I MISPELLED ANYTHING (Y/N) ?N
IS THIS YOUR FIRST TIME ON THIS SYSTEM
(Y/N) ?
```

... and leaves a message from CQ. Those codes at the top are the commands for using the bulletin board. The program types a question mark whenever the human is supposed to do something.

```
C=CONTINUE ENTRY
D=DELETE A LINE
E=EDIT LINE
L=LIST LINE(S)
R=RESTART FROM BEGINNING
S=SAVE MSG TO DISC
```

```
(A,C,D,E,L,R,S,?) ?S
SAVING MSG TO DISC....
```

FUNCTION:

```
(A,B,D,E,G,H,K,L,N,Q,R,S,T,V,W,X,?) ?E
THIS WILL BE MESSAGE #66
SUBJECT ?COEVOLUTION QUARTERLY
TO ?ALL
LOCK (Y/N) ?N
YOU MAY NOW ENTER UP TO 16 LINES OF
UP TO 64 CHARACTERS OF TEXT PER LINE
1?GREETINGS TO CBBS USERS FROM COEVOLUTI
ON QUARTERLY
2?WE ARE RUNNING AN ARTICLE ON
3?COMPUTER NETWORKS IN THE SUMMER
4?ISSUE
```

Step-by-step, Dave types in Bonnie's phone number and sends her a message. The program asks "Mode?" meaning: Hold on to it (N), Send it now (I), or Send it at a certain time (D)? As it dials her number, the program types those spaced-out digits. Then it tells Dave his message is sent ("Carrier") received ("Got...") and deleted from its own computer ("killed"). It always keeps track of the time at the very bottom.

ALTERNATE MEDIA CENTRE TELETEXT STUDY.

Funded by the Corporation for Public Broadcasting. Contact: John Carry, New York University Alternate Media Centre, 144 Bleecker Street, New York, NY 10012.

Teletext resembles Viewdata visually; but it's a constant stream of text and pictures broadcast over a TV station, each piece of information coded with pre-selected keywords. Users program their terminals to catch only those items of personal interest as they whiz by.

"We see our Teletext as a large-scale system for the public," Carry said. "Maybe four or five years from now the price will be low enough." In the meantime, the Corporation for Public Broadcasting paid for research into possible uses of Teletext for people overlooked by the mass media, such as neighbourhood associations and the handicapped.

Last year, Alternate Media Centre organised the highly successful Berks County, PA, community interactive TV system, in which senior citizens and community members use TV cameras, cable TV and telephones to make an electronic community out of their County. Now they hope to raise funds to demonstrate their Teletext system in Washington, D.C. some time next year.

Teletext systems are currently operated by TV networks in Britain under the names Ceefax and Oracle.

DIGICAST.

San Francisco, beginning sometime 1979. Proposed by the Digicast Project, an informal group of computer scientists, engineers and electronic manufacturers. Contact: Jim Warren, 345 Swett Road, Woodside, CA 94062.

Like Teletext, Digicast will transmit words and pictures over broadcast waves in a steady stream. Using Sub-Carrier Authorization channels, which are unused FM frequencies linked to existing radio stations, Digicast will be a steady stream of news, financial data, real estate listings, classified ads, weather, computer programs and library resources.

To receive it, users will need a modified personal computer (\$600-\$1200) with a radio receiver (\$100). As in Teletext, the computer will pull out only those items which it has been programmed to catch.

Digicast will be free; but project members will start businesses to make terminals, sell advertising, or produce the information. Organiser Warren is known as the founder/editor of several computer hobbyist magazines, one of which, the Intelligent Machines Journal, carries news about Digicast.

PCNET (PERSONAL COMPUTER NETWORK).

Nationwide. Available from the PCNet Committee. Contact: David Caulkins, co-ordinator, 340 East Middlefield Avenue, Mountain View, CA 94043.

Caulkins wrote a CQ article several years ago when PCNet plans were still tentative; since then, his committee of volunteers have developed an electronic mail system for Commodore Pet personal computers over telephone lines. Most of the work involved developing a program which directs computers to dial each other's numbers to leave messages in other computers' file, and to correct the large numbers of errors caused by garbled phone-line transmission.

An ingenious method of bouncing messages

from one computer to another helps avoid costly long-distance phone rates. Pet computers with telephone connectors (modems) cost about \$1100; users feed PCNet programs (about \$8) into their computers. There is no central switching computer.

"That's our political decision," Caulkins said; decentralized networks are harder to control. To protect privacy, users are encouraged to develop automatic message-encoding programs. Future plans include adapting other microcomputer brands and sending the message over short-wave radio. *Personal Computers* magazine's Oct-Nov issue carried a long description by Caulkins of how the system would be used.

THE COMMUNITY MEMORY PROJECT.

San Francisco, beginning sometime 1980. Sponsored by the Community Memory Project. Funded by contributions. Contact Sandy Emerson, 1814 Ward Street, Berkeley, CA 94703.

Convinced that computer networks should be decentralized, open to everyone, and service/community orientated, Community Memory put inter-connected terminals in Berkeley public places between 1973 and 1975. People used them as an electronic bulletin board for filing news, messages, classified ads and poetry. Others used the terminals to pull out information with the appropriate keywords, or to add comments to existing messages.

A new, similar system will be established in a San Francisco neighbourhood; up to 20 terminals will be placed in community centres and neighbourhood gathering places. All information in the system will be entered by the people who use it.

As an experiment, high-tech users accustomed to home terminals will find it limited and inconvenient, but it's one of the few systems that does not require people to own their own terminal in order to use it.

THE SOURCE.

Nationwide. Unveiled at the New York Computer Fair, June 2, 1979. Available from Telecomputing Corporation of America, itself a subsidiary of Digital Broadcast Company. Contact William Von Meister, chairman of the board, 1616 Anderson Road, McLean, VA 22101.

"One of the most heavily capitalized (\$34 million) companies in the history of this country," this is the first home-terminal consumer information network put on the market in America, and probably the most ambitious. People with home terminals will call for specific information, including any UPI article of the last seven years, programs in Cobol, Basic and Fortran, airline information and video games.

In addition, the source will offer electronic mail to other terminals, and a unique electronic mail system to people without terminals — for 75¢ your computer message becomes a Western Union mailgram dropped off at O'Hare Airport.

All this will be transmitted over Telenet, a private data communications cable network more suited than telephone lines to computer signals.

All information on the data banks is chosen by the company, based on customer demand. Some services are paid for by advertising. People can send one message to a group of others — everyone interested in alternative

energy in Virginia, say — for 15¢ per recipient.

News services would be censored only because of "irresponsibility of editors — four-letter words," von Meister said. What about for political reasons? "You know we wouldn't." Records are kept of how much each piece of information is called up, but not of who is calling for what. DBC offers a \$5000 reward to anyone who can break into someone else's private messages on the system.

To connect, you need a personal computer and telephone hookup (\$1000) or a data terminal (\$595 and up), plus \$2.75 per hour of use. The service is limited to off-business hours and weekends, when Telenet rates are cheaper. The cheap cost is a big selling point; "There's no reason we shouldn't be within 10% of the nation's homes in five years," von Meister said.

ELECTRONIC INFORMATION EXCHANGE SYSTEM

(EIES). Nationwide, begun October, 1976.

Funded by National Science Foundation; organised by Murray Turoff, New Jersey Institute of Technology, and Starr Roxanne Hiltz, Upsala College. Contact: Turoff/Hiltz, Computerised Conferencing and Communications Centre, New Jersey Institute of Technology, Newark, NJ. 07102.

Early government computer networks, such as Arpa-Net (Department of Defense) and EMISARI (Office of Emergency Preparedness), brought scientists and social scientists together electronically to collaborate on government research. These networks planted seeds for later, more experimental networks whose purposes centre around developing the form of computer communication itself.

Along with Forum/Planet (started at Institute for the Future, Menlo Park, CA; now managed as a business network by Jacques Vallee's Infomedia Corporation) EIES is probably the most influential in developing social contexts with which people will find each other through computers.

EIES messages travel over Telenet; EIES is a system of subnetworks, each centred around an interdisciplinary research topic such as Futures Forecasting or General Systems Research, each with 50 members. Members collaborate on research, send cross messages and immediate responses, introduce themselves to each other via keyboards that signal common interests, and gradually build up on-line libraries of relevant information.

A micro-processor is being programmed to search data bases at the request of EIES users, and the frontier seems to involve

communication with or through computers that develop an independent identity — either terminals that act as extensions of their owners when they are at them, or computer programs that stimulate personalities and social systems.

To connect, you need to apply at the address given above. Limited funding is available for a three-month trial period; otherwise, people with a reasonable idea for using the system can buy membership slots in areas of special interest for \$66 monthly and \$3.75/hour (cost of Telenet). Groups can buy a slot co-operatively.

For \$100,000, a group can buy the hardware to create their own EIES-like system. Software and maintenance is extra. More detailed information is available in articles by Turoff and Hiltz (the best perhaps, in the *IEEE Spectrum*, May 1977), or in their book *The Network Nation*.

One sub-network is actively exploring the possible uses of computer networks in neighbourhoods and local communities. Participants include former members of *Rain* magazine and the institute for Local Self-Reliance, as well as some members of Robert Theobald's Linkage System and Peter and Trudy Johnson-Lenz, EIES researchers, who helped organize a computer-aided neighbourhood resources network outside Portland, Oregon several years ago.

For more information contact: Johnson-Lenz, 695 Fifth Street, Lake Oswego, OR 97034.

PANALOG.

Started December, 1977. An informal group of information scientists based at General Telephone and Electronics Laboratories in Waltham, MA. Contact: Ed Houseman, GTE Labs, 40 Sylvan Road, Waltham, MA 02154.

Housman used excess computer time on the GTE computer to establish his own informal computer conferencing network. Members of the network, mostly members of the American Society for Information Science, have used it as a research bulletin board, for entering messages and responding to them, on the subjects of information theory and the office of the future.

Informal networks for the deaf and for teenagers were also set up on the same system. It was written up recently in the June, 1978 issue of *Basis*, the Bulletin of the American Society for Information Science.

ADVANCED COMMUNICATIONS SERVICES (ASC).

Nationwide. Subject to FCC approval.

"Pinwheel" being enjoyed by preschoolers in Columbus, Ohio on QUBE, Warner Cable's two-way cable TV service. "Pinwheel" is made up of original videotaped segments featuring puppets, mime, music and dance. "Pinwheel" will be distributed on Nickelodeon, Warner Cable's young people's satellite network, to cable TV operators.



Proposed by Xerox. Contact: Sandy Lanzarotta, 701 South Aviation Boulevard, El Segundo, CA 90245.

Xerox and AT&T are both proposing data communications networks on a grander scale than phone lines or private wire networks. Trade magazine *Datamation* described ACS as a giant amoeba, swallowing smaller networks in its path.

ACS signals would travel over a network of cable and switching computers; XTEN would use satellites to transmit radio frequencies of 10 gigahertz, near the electromagnetic border between radio waves and micro waves. Both propose elaborate systems which would accept many different types of terminals and computer hook-ups, provide electronic mail and conferencing, rent computer programs and store data.

XTEN would also transmit voices and facsimile documents. Both are aimed at businesses, which would establish their own closed sub-networks within the larger system, but both ACS and XTEN could be adapted to home use and presumably would be if there were enough demand.

Anti-trust regulations may prohibit ACS, because AT&T is not allowed to sell data processing. It is also not certain what effect XTEN's radio waves would have on public health. We found no non-technical articles about these systems, but trade magazines like *Datamation* and *Infosystems* have reported on them since last summer.

Regulatory questions

THE EMERGENCE of computer networks puts the Federal Communications Commission in the middle of a complex tangle of regulatory questions, including the uncertainty of its own survival. The 1934 Communications Act, which created the FCC, separated regulation of broadcasting from that of telephone communication, a decision evolved from the conflict between rail travel and the telegraph in the 1800's.

As computers developed, The FCC chose not to regulate them at all; and new digital technologies threatened the AT&T monopoly over person-to-person communications. Now the FCC is faced with the problem of defining what is communication and what is data processing.

According to Gary Rosch, an attorney with the FCC's International and Satellite Branch, FCC commissioners are concluding an inquiry into the relationship between computers and telecommunications. Their intention is to encourage competition and restrict communications networks from dominating computer services.

Based on this inquiry, the commissioners will decide which FCC-regulated computer/communications systems can offer which types of services. At stake is the choice between one, centralised communications system, or the growth of many smaller overlapping and competing networks. In the meantime, the Communication Act, currently being rewritten, could abolish the FCC or reorganise its powers entirely.

The future

Will computer networks make people happy? Their eventual effect on people and society is not certain, but there are some preliminary observations:

□ Despite the enthusiasm of proponents, there's lots of doubt that the public is interested enough in two-way electronic networks to spend much time or money on them. No consumer computer network has yet shown signs of being a great commercial success. However, networks which see themselves as alternatives to "commercially generated and corporately controlled information" (*Community Memory* brochure) hit pockets of enthusiastic response from people who are not satisfied with the straight media.

□ Lots of electronic mail ends up being as personal as face-to-face talk. People form friendships, have arguments, crack jokes. Good writers and more literate people have the same social advantage that good looking people have face-to-face.

□ A two-way vide screen is not nearly as hypnotic as one-way TV, because communicating back requires rousing oneself from the video trance.

□ The old problem of computers being more exact and consistent than people makes it hard for people to find specific information sometimes. No index system can anticipate all the ways people can refer to something. Peter and Trudy Johnson-Lenz, researchers on the EIES network, suggested the developing information shepherds — a cross between directory assistance operators and reference librarians, who keep the indexes coordinated and direct people to the proper keywords.

□ People get overloaded with electronic information because access to it is so easy. One response, proposed by Johnson-Lenz, is programming one's terminal to sort through the incoming mail/data and display the most important stuff first. Another response is not using the system so much. People who belong to more than one network often find it hard to keep up.

□ Uneducated or disadvantaged people may be deprived of opportunities if they cannot get access to terminals or learn how to use them. However, if they do get access, much of the subconscious prejudice against minorities, women, the young and old, disappears.

□ Words and numbers are easiest to translate into digital signals; but the following can also be transmitted through computer networks with the proper terminals: music and sound, line drawings, half-tones, video, animation, mechanical vibration and facsimile reproduction.

□ There is a great potential in commercial networks for substituting interactive video experience for "real life." Thus far, however, we have not found any examples of anyone who has done this.

Computer paranoia cuts both ways

by Dirk Hanson

A REPORT COMPILED for the business community by Stanford Research Institute's Business Intelligence Program says: "The reason (distributed processing) computer networks will not be available to the general public at an earlier date is primarily one of security. **At present, fraudulent input or access to a data base management system cannot be prevented.**"

This is a vital piece of information that the industry does not want you to know. There's this security problem. Large, flexible time-shared computer systems are Swiss cheese. Ask a programmer. Computer crime is a growth industry. Computer security is a myth. For every new data encryption system, there's a programmer out there somewhere who can crack it. A program that sneaks you into an operating system is called a Trojan Horse. At most computer centres, the Trojan Horse is already inside the gates.

Some grim worst-case scenarios might just be floating through corporate corridors these days. Striking British civil servants recently turned off key government computer systems, and the result was chaos. Some of the information and assets probably will not be recoverable. The strikers simply pulled the plugs. Crude, but effective.

But what about the likelihood of more sophisticated guerrilla tactics, as computer know-how spreads throughout the populace?

Quite a quandary for industry people: they want you as a customer, but can they trust you? They need to sell you computers and teach you the mechanics of programming, but they don't want to let you too far into the distributed processing loop. They need your business, but they're scared of you. No kidding. As time goes by, you could become too smart for their own good.

Computer paranoia cuts both ways. The industry may be nervous about widespread consumer participation in future networks, but it seems much less concerned about consumer privacy abuses in current systems.

It's common knowledge — at least it should be — that information which goes into such systems, information about you, your habits and activities, information from which your preferences can be deduced, is accessible to almost anyone. Credit records, criminal records, medical records, driving records, financial data — the whole gamut. Right now, most of it is fair game.

It's a muddy affair. Who decides who gets access to what? There's reason to be wary of controls and limitations on access to digitized information, and equal reason to worry about what will happen if there are no such controls. The deciding in theory will be a sociopolitical matter; the accessing in truth will be by those who know how. And the what being accessed will be almost everything.

NEW UNBEATABLE 1980 PRICES NOW!

EXPLORER/85

Professional Computer Kit

FEATURES INTEL 8085 CPU WITH ON BOARD S-100 EXPANSION



FLEXIBILITY: Real flexibility at LAST. The EXPLORER/85 features the intel 8085 cpu 100% compatible with all 8080A and 8085 software. Runs at 3MHz. Mother Board (Level A) with 2, S-100 pads expandable to 6 (Level C).

MEMORY

2K Monitor ROM
4K WORKSPACE/USER RAM
1K Video RAM
8K Microsoft BASIC in ROM or Cassette.

NEW S100 Bd

16K Dynamic RAM Kit £139 + VAT
Expandable to 64K in one BOARD
Extra 16K Kits 88.95 + VAT.

INTERFACES

STANDALONE FULL ASC11 Keyboard Terminal, 32/64 characters per 16 lines.
Cassette interface (with motor control and cassette-File structure).
RS-232/20Ma Loop, 4, 8bit. 1, 6 bit I/O ports, programmable 14bit binary counter/timer
Direct interface for any S-100 Board.
FULL Buffering decoding for S-100n Bus pads, wait state generator for slow memory.
Each stage has separate 5v 1A regulator for improved isolation and freedom from cross talk.
P. S. U. requirements: 8v, 6.3v AC.
Runs with North Star controller and Floppies/CPM.
EXPLORER/85 is expandable to meet your own requirements with easy to obtain S-100 peripherals.
EXPLORER/85 can be purchased in individual levels, kit form or wired and tested. OR as a package deal as above.

£275 + VAT

Microsoft BASIC on Cassette

16K £376 + VAT

32K £459 + VAT

48K £540 + VAT

64K £625 + VAT

Microsoft BASIC in ROM

AVAILABLE NOW!

WE ARE KILLING INFLATION WITH

ELF II

THE TRIED AND TESTED
MICROCOMPUTER
SYSTEM
THAT EXPANDS
TO MEET
YOUR NEEDS

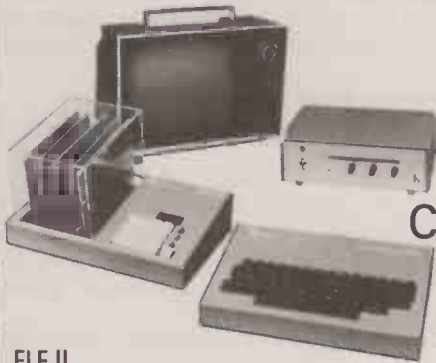

Computer Kit

STARTS AT
£59.95
+ VAT

ELF II
BOARD WITH VIDEO OUTPUT
FEATURING THE RCA COSMAC 1802 CPU

STOP reading about computers and get your "hands on" an ELF II and Tom Pitman's short course. ELF II demonstrates all the 91 commands which an RCA 1802 can execute, and the short course speedily instructs you how to use them.

ELF II's VIDEO OUTPUT makes it unique among computers selling at such a modest price. The expanded ELF II is perfect for engineers, business, industry, scientific and educational purposes.

NEWTRONICS KEYBOARD TERMINAL T £114.20 + VAT

The Newtronics Keyboard Terminal is a low cost stand alone Video Terminal that operates quietly and maintenance free. It will allow you to display on a monitor 16 lines of 64 characters or 16 lines of 32 characters on a modified TV (RF Modulator required).

The characters can be any of the 96 ASC II alphanumeric and any of the 32 special characters, in addition to upper/lower case capability it has scroll-up features and full X-Y cursor control. All that is required from your microcomputer is 300 baud RS232-C or 20ma loop serial data plus a power source of 8v DC and 6.3v AC. The steel cabinet is finished in IBM Blue-Black. And if that is not enough the price is only £114.20 + VAT as a kit, or £144.20 + VAT assembled and tested. Plus £2 P&P (Monitor not included).

THE ATARI VIDEO COMPUTER SYSTEM £138 + VAT

Atari's Video Computer System now offers more than 1300 different game variations and options in twenty great Game Program TM cartridges! Cartridges now available All at £13.90 each + VAT
Basic Maths, Airsea Battle, Black Jack, Breakout, Surround, Spacewar, Video Olympics, Outlaw, Basketball, Hunt & Score*, Space War, Sky Diver, Air Sea Battle Codebreaker*, Miniature Golf

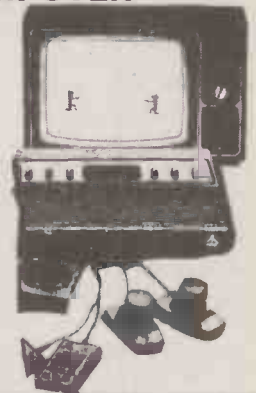

Extra Paddle Controllers — £14.90 + VAT
*Keyboard Controllers — £16.90 + VAT

RACAL AP12. C12 TAPES: 10 for £4.50 + VAT

NOW AVAILABLE 8K FULL BASIC FOR ELF II

NEWSOFT GAMES FOR ELF II: 4 for £5 + VAT

ELF II EXPANSION KITS

- Power Supply(6 3v AC) for ELF II
- ELF II Deluxe Steel Cabinet (IBM Blue)
- Giant Board Kit System/Monitor. Interface in cassette. RS232, TTY, etc.
- 4K Static RAM board kits (requires expansion power supply)
- Expansion power supply (required when adding 4K RAMs)
- ASCII Keyboard Kits 96 printable characters, etc.
- ASCII Dilux steel cab (IBM Blue)
- Kluge prototype board (build your own circuits)
- 86 pin Gold plated connectors, each
- ELF Light pen writes/draws on TV screens
- Video graphics board 32/64 characters by 16 lines on TV monitor screens
- ELF II Tiny basic on cassette
- ELF Bug/monitor powerful systems monitor/leditor
- T. Pitmans short course in programming manual (nil VAT)
- T. Pitman short course on tiny basic manual (nil VAT) £3.00
- RCA 1802 users manual (nil VAT) £3.00
- On cassette Text Editor, Assembler, DisASSEMBLER leachi

Ex. VAT

£5.00

£19.75

£25.50

£57.50

£19.00

£38.95

£12.75

£11.0

£3.75

£6.00

£61.50

£9.75

£9.75

£3.00

£3.00

£12.75

ELF II BOARD SPECIFICATION

* RCA 1802 8-bit microprocessor with 256 byte RAM expandable to 64K bytes.
* RCA 1861 video IC to display program on TV screen via the RF Modulator
Single Board with Professional hex keyboard fully decoded to eliminate the waste of memory for keyboard decoding circuits
Load, run and memory protect switches
16 Registers
Interrupt, DMA and ALU
Stable crystal clock
Built in power regulator
5 slot plug in expansion bus (less connectors)

SEND SAE FOR COMPREHENSIVE BROCHURE

Please add VAT to all prices (except manuals). P&P £2. Please make cheques and postal orders payable to NETRONICS or phone your order quoting BARCLAYCARD, ACCESS number.

We are now open for demonstrations and Sales, Monday-Saturday, 9.30 a.m. - 6.30 p.m. Near Highgate Underground, on main A1 into London.

NEW ADDRESS:

H.L. AUDIO LTD.
255 ARCHWAY ROAD
LONDON N6 5BS

Bigger Premises

New Phone No. 01-348 3325 DEPT. WW

• Circle No. 187

The Randomiser

by John Abbatt

A decade after Hunter Thompson, a new menace presents itself at the portals of America's capital of gambling, Las Vegas. But this time the fear and loathing is on the side of the organisation. For the Boy who came to the casinos had the key to the machines . . .

THE GAS restrictions dragged the speed of the Greyhound bus down to 40 mph, so that the long haul from San Francisco to Las Vegas became even longer. For the last hundred and fifty miles it beetled its way across the burning dust plain of the Nevada Desert, compressing the passengers in air-cooled boredom.

As Westerners will, they exchanged endless biographical detail with one another; some slept awkwardly; and the three Chicano youths on the back seat took it in turns to slip into the can to smoke a joint.

The Boy sat by a window; to his right, a heavily-built Caucasian in a smart lounge suit had wedged himself. He rapidly tried to strike up a conversation and revealed himself to be a Latterday Saint.

The Saint had realised the possibilities of the bus network as a means of cornering potential converts. He had taken a month's bus pass and spent his days and nights criss-crossing the long-haul routes, handing out tracts and sermons, and collecting names and addresses.

He soon realised that the Boy would be a hard nut to crack. He answered all leading questions monosyllabically and, when handed his first tract, turned it over instead of at least pretending to read it. On the back he copied the number from his baggage check and then covered the page with small, neat calculations.

"Them looks mighty fancy sums, boy," persisted the Saint.

"I'm randomising," said the Boy.

At Las Vegas they all alighted, gasping as the 118°F heat struck at them. The Boy reclaimed his backpack, walked into the terminal building and stood in momentary indecision.

HE was fair-haired and compact. He had steered his adolescence through the twin hazards of acne and obesity, and had emerged into his twenties with a muscular figure and a face more rugged than handsome. His T-shirt, crumpled by the journey, bore the faded legend "I FINALLY GOT IT ALL TOGETHER. NOW I DON'T KNOW WHERE TO PUT IT," and the machine-frayed bottoms of his cut-downs clung limply to his perspiring legs.

He took in the interior of the building. It was very crowded. The gas shortage was wrecking the schedules and the belligerent Pinkerton Securiman, job-selected more for bulk than brain, had difficulty in keeping order among the human flotsam that littered the lounge.

"Excuse me, but I have to make a phone call. Could you change two dollars into quarters for me?"

SHE put down her huge case behind him. The overall beauty almost struck him dumb. She had very little make-up and a simple cotton dress and sandals. The skin had a natural golden glow indicating distant origins south of the Rio Grande.

He found the coins for her and she thanked him.

"Could I ask you another favour? Would you just keep an eye on this case for me for a few minutes? I just got in from Provo."

There was no man alive who could have refused her.

She was back five minutes later. "Thanks. They've cancelled the San Diego bus so I had to let my folks know I'm staying overnight. Have you any idea how to set about getting rooms in this town, I've only got 35 dollars?"

He smiled at her. "I was just figuring out the same problem. Maybe we could share a cab and try to sort something out."

She paused and looked at him a little more closely. Evidently he passed some sort of test for she held out a slim, golden hand.

"Donna Marelli," she said.

He took it. "Jay Waleski."

She gave a little squeeze, which did something electrical to his nervous system, and somehow they had made a contract.

The motel clerk was part Chinese and he had 90% of his attention focussed upon a TV baseball game. He flicked a glance at them.

"One double forty-five dollars."

Jay opened his mouth to speak but then caught Donna's eye. She gave a little shrug of acceptance.

It was a typical Vegas motel room. Smart furniture, a king-sized bed seven foot square, a huge mirror on the opposite wall and a shower large enough for two. The air-conditioner was turned up to the point of discomfort and Jay adjusted it.

DONNA'S face was dimpled in concern. "I don't know what you think about taking a double, Jay. I don't want you to get the wrong ideas about me. It's just that I can't afford a single room."

"Don't worry about a thing. This bed's so big it might as well be two singles," he reassured her.

As they unpacked they talked. Her folks ran a San Diego restaurant and she was on her way back from visiting relatives in Utah. She was in her last year at college and beginning to think about possible careers.

Jay said very little and only half-listened. The voice, the face, the innocent brown eyes and the tinkling laugh simply mesmerised him.

"I've never been here before," she said. "I'd love to have a look at the town but I don't think it's the sort of place a girl should wander around on her own."

Jay paused and thought before answering. "Well I'm going to go round the casinos myself. Would you like to come along and help me?"

"Why that would be great, Jay, but I don't want to put you to any trouble."

"No, another pair of hands would be useful. I must tell you why I've come here: I think I know how to beat the slots."

She laughed again, not unkindly. "Isn't that what they all say, Jay?"

"NO, let me explain. You have to understand how they work. The pictures of fruit, the bells and bars are set on four reels which spin round and then stop to produce a random result in front of a window. There are inertia and timing devices which activate small magnets to apply a break to each reel. The thing is that they are electro-mechanical so they can never be truly random. If you write down all the results, eventually you can pick up a pattern and start predicting them.

"Last year some guys hit upon the idea of using computers to detect these sequences. They would take a hundred turns on the handle and make a note of the results. Then they would take it back to a portable computer at their motel and it would print out the full sequence. That way they could go back to the machine and start predicting the jackpots.

"Pretty soon the casinos guessed what was happening so they got together to find a solution."

She nodded. "You mean they bought them out or threatened them?"

"No — it was too widespread by then. They had to change the machines to make them more random and they hit upon the idea of fitting microprocessors to generate random numbers and



operate the reel brakes. They are actually cheaper to make and the machines last longer and need less maintenance. I suppose all this sounds a bit technical to you, Donna."

HE had provoked the first flash of anger from those eyes. "I know I'm a girl, Jay, but I did get good grades in maths and sciences. You still haven't told me how you are going to beat the system."

"Sorry. Well, you see the microprocessors all use a randomising algorithm that I originally designed. When I was at Stanford I decided to make random number generation my thesis. No-one else wanted it as it didn't seem to have career potential. They were wrong; it has uses in balancing ship loading, storing data, cryptography and of course gambling.

"I took randomising theory a lot further than anyone had before. When I graduated from college I started freelancing and it wasn't long before I was selling algorithms to some of the microprocessor firms in Silicon Valley.

"To shorten the story, the guys who were using one of my algorithms in the micros for the new slot machines broke contract with me. I should have had a percentage on every micro installed, but they got me on a technicality and I didn't have the money to sue them.

"So now I figure to take back what they owe me direct from the machines, and maybe some more besides. There is no theoretical upper limit to the amount of money I can get in this way."

Donna opened her mouth to speak again but he cut in. "I know I still haven't explained how. Well look at this."

He reached into the side pocket of his backpack and removed a bundle of cloth. Then he unwrapped it carefully to reveal a machine resembling a hand-held calculator.

'So now I figure to take back what they owe me direct from the machines and maybe some more besides. There is no theoretical upper limit to the amount of money I can get in this way.'

"I've got one of the micros in here. They gave me this special version to do the testing: it's programmable. The way it works is that it starts off with a four-digit number, 2468: they all start the same. The first guy who uses this machine pulls the handle and activates four hundred successive randomising calculations while the reels are spinning. At the end they come up with an eight-digit number which determines the points at which the brakes will operate. For the next go, it takes alternate digits from the last number and randomises on those, and so on.

"Now the important thing to know is that on the back of each machine there is a visible sequential counter. It clocks up one for each use of the machine. By taking successive readings of this you can work out how many times the machine has been used. You can work out how often to empty them and service them without opening the case.

"You see what that means? I know the original base number and how many times that the randomising module has been used, and I have a cross-check to the symbols actually displayed in the window. I key these facts into the micro, run my program, and it produces two numbers. The first is the number of goes to the next win; the second is the yield."

Donna shrugged. "Well all I can say is that it sounds great the way you explain it but I'll wait until I see it work."

"There's just one thing you ought to know. Attempts have been made to get this machine back off me. They offered me \$1000 then \$2000. Then my apartment was broken into and four nights ago a truck nearly ran me down. That's what made up my mind for me; but it's just possible that they could catch up with me here and I don't want to put you in any danger."

She turned on her smile easily. "Well it sure sounds a lot more

exciting than going to San Diego. Come on Jay, they use women as mascots in this town I believe, so let me be your luck."

THEY took turns to shower discreetly and change into clean clothes and he told her about randomising with the warmth and enthusiasm that overtakes a man turned on to his consuming speciality. He told her of all the diseases that afflicted randomising algorithms and made them start repeating themselves. He explained about looping, about function decay and centre-square regression.

He told her that most randomisers made the mistake of operating in decimal, but he had chosen binary because it was simpler and faster. He described the principles of introducing sign bits and parity bits and clock cycle interrupts...

She nodded and made encouraging noises and he was still in full flow until they opened the door, walked out to the Strip, and the heat nearly felled them to the sidewalk.

The sign on top of the Sahara lit up and said "15.30" then it went out, lit again and said "1170".

IN spite of the searing heat the town was very much alive. The big casinos stood like sentinels spaced out along the wide road, with no pretence to modesty. Each attempted to outdo the other in signs, in decoration or in sheer vulgarity. Gas-hungry cars sped along the roads vying with taxis and buses. Women plied for trade from the shadows and entrepreneurs thrust vouchers into the hands of passers-by which offered free drinks, free long-distance telephone calls, free food, even free money. Anything as long as you stepped across the threshold into the casino.

In fact the visitor had little choice, for the best food, entertainment, hotels and above all air-conditioning could only be had in these concrete oases.

Jay and Donna needed no inducements, but picked their way from shadow to shadow and entered the Sahara, stopping stunned inside the entrance.

He had read about it, seen pictures of it and knew what to expect, but anticipation did little to blunt the initial impact of that sight. The vast, windowless room twinkled with flashing lights and throbbed with the click of roulette wheels, the calls of the blackjack operators, the satisfying crunch as the handles were pulled on the slots, and the raucous bells which sounded each time that a jackpot came up, which was about every two minutes.

There were thousands of people in there, lost in a gambling-induced, adrenalin-charged mesmerisation. They stood with paper cups full of money, sometimes playing several machines simultaneously. Eating, sleeping, the value of the money they were using, all were lost in the fascination of the spinning reels. In a few decades, the machines had evolved to appeal simultaneously to all of the senses, and more subtly to all of the deadly sins. The percentages were finely balanced to produce an adequate profit but to provide sufficient yield to entice in the next coin.

Donna nudged him back to reality. "Where do we go?"

He wished that he knew the answer. As his eyes adjusted he scanned the area where bookmakers took bets on racing, baseball and any other sport that was being projected live onto huge TV screens, past the roulette tables where elegantly dressed, slim women egged on enthusiastic business men, and swarthy, obese men with bejewelled fingers pushed fifty-dollar bills into table slots and measured out glittering plastic counters. Then he saw them, a bank of about fifty of the new machines, at the far end.

They changed five dollars into quarters and rattled the twenty coins in the bottom of a paper cup, an insignificant drop in the tide of money that was flowing past them.

THEY evolved a routine. He would stand near the back of the machine and key the number from the counter into the micro concealed in his palm. She would call out the symbols on display from left to right and he would mentally convert them into numbers and key them in as a cross-check. Then he would run his program and the LED display would show two numbers. The first machine gave 16 and eight. It would give an eightfold return in sixteen goes, a 100% loss. They worked their way through the next five machines and struck gold on the seventh. It was going to

jackpot in five goes with a 200 yield.

He was tempted to take it but took a grip on himself and passed on. The place was well-scrutinized by concealed cameras by the uniformed staff and quite possibly by many well-armed and alert employees posing as customers. They would soon be on to them if they did nothing but win jackpots.

The next machine promised a yield of 25 in five goes, a 400% safe profit. They took it and it worked. Donna stared in disbelief as the coins cascaded into the tray on the fifth pull. "We just made five dollars, I don't believe it."

He squeezed her hand. "'Oh ye of little faith'; let's take them."

THE logistics soon became apparent. It took two minutes to assess a machine, on average every fifth machine was set for a profit, and the average profit was five dollars. However the machines were fixed with arrangements to increase your bet by entering extra coins to gain a corresponding increase in the odds. On this basis they could average forty dollars a win or 240 an hour.

At intervals they took it in turn to visit the change desks to turn the coins into notes which Donna put into her zip bag. They gave it an hour and then moved on to the Silver Bird, followed by the Stardust, the Silver Slipper, the Sands and finally Caesar's Palace. Pretty soon they abandoned the quarter slots and went over to the dollar machines.

He paid off the taxi at midnight and they staggered into the motel room and threw themselves on the bed. Their ankles were swollen, their throats dry and their wrists aching, and they were rich. Pretty soon they started pulling out notes. Donna unzipped her bag and emptied it on the bed, Jay emptied his pockets, and finally they took to burrowing into their underwear, she into her brassiere and he into his shoes, until the cascade of paper finally stopped.

They started counting. "\$6249" he announced. "Half of it's yours, Donna."

"No, I won't hear of it, Jay. It's your machine, your idea, all I did was pull the handles for you."

He decided not to press her. "Come on, let's stuff it in a drawer and sort it out in the morning."

Shyly they washed and undressed. He stayed in his underwear and she produced a modest nightdress. They crept into opposite sides of the huge bed.

"Goodnight."

"Goodnight."

It occurred to him that in spite of her attractions and the bond that had been forged between them, not once had it shown itself as any gesture of affection. He switched off the light and two minutes later he was asleep.

ACROSS the courtyard in the motel office stood a man of monolithic dimensions looking out of the window. The motel clerk was reading a newspaper, tense and sweating, with the equivocal smile of one who knows that the worst may well happen but clings to some inborn optimism that perhaps he might still survive the night in one piece.

The big man pushed him rudely away from the phone and dialled a number. "The light just went out," he said.

A passing police siren woke Jay and he lay staring at the daylight patterns on the ceiling.

During the night something had happened between him and Donna. He had no idea when it had started or how long it had lasted, but she had roused in him elemental passions beyond anything that he imagined that he possessed. She herself had been transformed, the innocence shrugged aside to reveal an undreamt carnality and versatility. He thought that it would never end but eventually he must have slept. He turned his head to look at her. She was gone.

The zip bag was gone and so was the case. Hesitantly he opened the money drawer. Everything seemed to be intact. Then he had a thought and went to the drawer where he had tucked the micro beneath his clothing. There was no sign of it. He pulled the drawer out and emptied it onto the bed. A single sheet of paper floated out with a message scrawled in eyebrow pencil:—

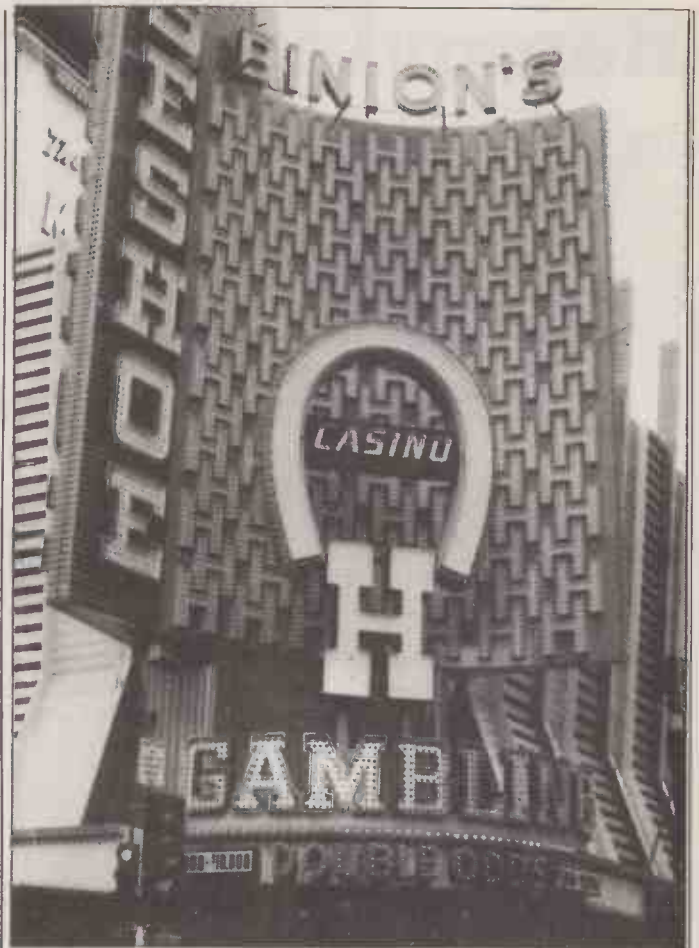

Jay — I hope that for my sake you will destroy this piece of paper but I felt I ought to write a word of explanation to you as I don't want you to look for me. I work for the guys who run the Strip. They can be very generous and they can be very mean. In your case they are generous because they admire a trier. Be sure that you do not see their other side.

We knew you were coming to Vegas and I was waiting for you at the terminal. We have taken the microprocessor. Now you should go someplace else and use your talents in other ways. In return you have over \$6000 and of course there was me. I normally rent at \$700 a night, so you had the best there is. They are going to wind all of the counters back on the slots so any thought you might have of continuing is hopeless as well as dangerous. Love, Donna.

THE Boy walked into the bathroom and took the top off the water closet. Then he fished out a dripping plastic bag. His back-up device was intact. It was a little cruder than the original because he had had to scavenge a lot of the parts, but it performed the same function. It would need reprogramming. The rows of symbols were visible through the windows of the slots and by keying them in it would be possible to derive the last random number generated and therefore the next sequence.

Donna had been a good actress. But even she had overlooked the fact that poor college girls do not have cases with the remains of Athens and Singapore hotel labels on them. She had not been able to disguise the pale bands on her fingers where rings had been removed. She should have checked that the bus she said that she had arrived on was there. While she had rung her "folks" he had simply ascertained that it was overdue. Finally she should have realised that girls who get off long-distance Greyhounds do not wear increased cotton dresses.

There were plenty of other gambling towns in the State. He would start with Reno. As for Donna, she was undervaluing herself at \$700 a night. Soon he would find her again and be able to offer much more.

Removing the buttons

by Nick Laurie

TODAY we are suffering a surfeit of combined electronic items typified by the cigarette lighter cum calculator. The future of the microprocessor lies in machines dedicated to one job and operated by people who are frightened by the word 'computer'. We already have the combined calculator stop-

watch, the tape-recording calculator and the calculating cigarette light. With the continuing reduction in costs, it will become possible to create ever more bizarre hybrids. But is this the real future of the micro-miniaturisation of electronics? And should it be?

The standard question goes something like this: 'But what does it *do*?' To which many personal computer owners will reply 'Anything!'. Yes, it can keep the household accounts straight, it can amuse (or even educate) the kids via the TV screen and, if you want, it can even make the tea for you.

But it can only do all this for *you* and for the few thousand other computer owners who happen to understand something of the complexities of programming: and therein lies an omen for the future . . .

Now, let us digress a little. There are TV games that utilise just a small part of the enormous computing powers of a CPU rather than holding a more limited dedicated games chip. With the addition of a little memory and a cassette unit these can offer a much wider range of games than the dedicated chip version while, at the same time, the manufacturers can offer upgrades by selling software fit only for their own machines.

Of course, it's not called 'software' because the mass market does not want big words with heady implications; in this case, the upgrades are simply described as 'extra games' and they are not sold exclusively through electronics magazines or computer shops but in the Sunday papers and the High Street stores.

Even the fact that these games are operated by a computer is less publicised than formerly — the computer-controlled washing machine is still being sold mainly on its good looks and cleaning abilities rather than because it uses a tiny fraction of a microprocessor's full potential to step its way through a simple program sequence.

Computer buffs

So we have a computer so cheap that we can afford to ignore nine-tenths of its capabilities and concentrate on a few functions only. On the other hand we have a large and erudite group of computer 'buffs', people who are rapidly learning their way around the hardware and software and who are possibly the

only large group really able to appreciate the true versatility of the micro.

Now let's have a quick look at some economic facts of life. Semiconductor manufacturers are able to offer us a product that costs very little to make once the very heavy development costs have been written off. These manufacturers tend to be giant concerns (because of those giant R & D costs) and they are not going to make the sort of money they want by selling a few thousand Z-80s at a few pounds apiece; what they would really like are sales running into hundreds of thousands, millions even if that were possible. Alas, there simply aren't ten million potential computer owners available in the market place to mop up their production — but there are many millions of *general* consumers . . .

Pretty vacant

There are two other parties in this developing scenario: the consumer and the software houses. The consumer is now an ordinary person who, in a highly technical society or even a highly technical job, does not usually have the time or the interest or even the need to become a programmer. The software houses would surely be happier if they could treat each piece of work as a one-off job, without the problems of selling and servicing hundreds of separate customers.

So, down to cases.

Peter James is an architect in a small county town practice. He has one partner and a junior fresh out of college. One secretary takes care of all the typing and general duties with the occasional help of a part-timer. Peter spends most of his time designing houses, extensions and does the odd bit of landscape gardening when it fits in.

Talk to him about buying a computer for the office and he thinks of accounting (which his accountant does perfectly well for him at the moment) and cataloguing (slightly more interesting but he is pretty familiar with most of the products he uses anyway) and he ends up with a blank sort of look showing that he has not really

mastered the difference between a transistor (a piece of silicon in a tiny tin can) and a transistor (a portable radio). His maths is of the 'A' level variety as he forgot the complicated bits ten years ago and remembers only the material relevant to his immediate work.

Hex is something to do with witches and spells. When faced with one of today's micros he shuddered, looked at the keyboard muttering that he couldn't type and really abandoned all hope and interest when he saw the maze of wires connecting box to box.

So our architect doesn't want a computer. We tried a new approach: 'Here is a machine that consists of a drawing board —'

'— That's more like it' from Peter —

'— and a television screen. Draw on here and it appears up there. You want to change a bit? Press the button marked ERASE and point to the wrong bit with this light pen and away it goes.'

'A sort of electric pen, paper and rubber?'

That's the idea, but there's more to come. Let's imagine you've done a ground plan and a first floor plan and you've picked a site for the client's new house. You're not sure if it's quite what he had in mind. What do you do?

Drawing trees

'I get the junior to draw up a finished version, work out the elevations from a couple of different viewpoints, sketch them out and get him to do a couple of tidy copies, draw in a tree or two and a cat and then offer it to the client.'

And if he doesn't like it?

'Why, do it again!'

And how long does all that take?

'Oh, about a week with luck.'

Okay, back to the machine. Sketch out a ground plan. Never mind the scale drawing; once you've laid out the general lines you can press this button marked DIMENSIONS, point to a line with the light pen, tap in the size on this keyboard here and — see, they all go onto the screen. Do that for all of them then press

the button marked **SCALE** and all the lines wriggle around to produce a perfect scale diagram: any misfits are indicated by a flashing arrow for you to sort out the same way.

'Magic,' says Peter. And this is not the time to contradict him. The consumer at this level doesn't care *how*, only *whether*.

There's more to come still. You wanted an elevation, so press this button marked **ELEVATION**, up on the screen comes an arrow for you to move around with your light pen, line it up with the viewpoint and you want and press the button again and up comes your elevation. Press the **TEXTURE** button and you can have the walls filled in and the roof tiled. Button marked **CAT** will put in your artistic touches to finish off the layout.

Now comes the real time-saver: a button labelled **PRINT**. Out of the slot comes a perfectly drawn version of the screen picture, cleaner and tidier than anything you could draw yourself. Wrap it up and send it to your client and if he doesn't like it, well, then you'll have to resign yourself to spending another hour at the machine doing another one. How long did you say . . . a week?

'It's not by any chance a computer, is it?'

You can actually hear the italics. Hasty reply: No, no, not a computer, it's an *Architect's Drafting Machine*; no programs or flashing lights or paper tapes. It's a straightforward drawing board that couldn't work out your bank balance in a week of trying!

I could hear the sigh of relief. Here was a machine dealing with his own concepts in his own language, and it didn't reflect so much as a sniff of technology more complicated than his own pens, paper and slide rule.

'Still, I suppose it'll cost a bomb.' He sighed again. 'Pity though, a gadget like

that could save . . .' A few calculations on his slide rule (yes, they really do still exist) followed by a gasp of astonishment: 'Ten thousand pounds a year — I want one!'

So what would it really cost? Well, this machine does exist today in a slightly different form; it will set you back about £20,000 even before you buy all the extras to make it as versatile as its designers intended.

The reason? It's simply too versatile. It can be adapted to be of as much use to a solicitor or a doctor because the designers wanted to cover as many possibilities as they could — after all the CPU can do *anything*.

The real machine of Peter's dreams will be a totally dedicated system useful only to an architect. So let's look at the costings on a dedicated drafting machine. A decent processor (about £60), a bit of memory, let's have 32K to cover most eventualities (around £200) and a floppy disc drive (we're already hearing rumours about the £100 unit), VDU (£50), a digitiser (a bit steep at £500 but well worth the money), a keyboard (£50 should be plenty) and a printer — call the printer £1000 and bear in mind that for some applications it could be a lot more, for others a lot less. The grand total leaves enough for a pretty plastic case without even reaching the £2000 mark. Then there's the software about which we won't say anything much except that it's on a chip costing all of a fiver, plus the cost of some decent documentation and an installation fee.

It still has to be marketed and lots of people have to make a profit, but even so it still comes out at a good deal less than the junior partner's car, it's all tax-deductible and very appealing at around £3000.

And what have we really done? We've followed the same course as the manu-

facturer of that TV game we started out with. Instead of going overboard on versatility, we've gone straight off in the opposite direction with a computer designed to perform only a limited number of functions. All we have to do now is count up the number of architects in the world and set out on a giant selling spree before moving on to the next group.

And there is a next group. Hundreds of them, in fact. We could now develop a machine for bicycle designers (same package, same innards, different legends on the buttons!), or a drafting machine for furniture designers, or kitchen designers, or, or, or . . .

Think simple

Then we start off again in a slightly different field from drafting machines. How about a gardening centre? In comes a family to buy a few shrubs: quick as a flash, we sketch out the garden on the screen, whack in a few dimensions, the amount of money they want to spend and their favourite colour (or whatever). A few touches with the light pen in conjunction with a simple keyboard and those bushes are in place. Press a button to see what they will look like in five or ten years' time — all a bit diagrammatic, but quite good enough.

A wipe and a press shuffles them out of the way of the swimming pool the customer hopes to build in a few years' time; another button moves the Scots Pine a little to the left so it does not cut out the sunlight from the living room next summer. Meanwhile, down in the bottom left-hand corner, a running total of the cost changes with each alteration until they have the perfect combination of what they want and the price they want. A last button prints out an order ready to hand over the counter to the sales assistant.

This one can't make tea either, or do the accounts, but it can sell gardening materials! In this case there needs to be a regularly updated link with the catalogue, but it might not be unreasonable to suppose that the major nurseries could be supplying their outlets with a floppy disc update to the catalogue — especially for this sort of use.

Today the jam-spreading alarm clock with built-in electronic cigar-cutter, tomorrow the separate jam-spreader, alarm clock and cigar cutter. The only real hurdle that prevents architects and garden centres from having these miracles is the reluctance of designers to think simple.

As you climb up into your den tonight to add yet another function to your breadboarded micro, just remember this: the machines of the future may well prove to be very much specialist-oriented, designed to do a single job and to be operated by people who know nothing about computers. Think of them as, instead of adding another row of buttons or switches, you remove one!

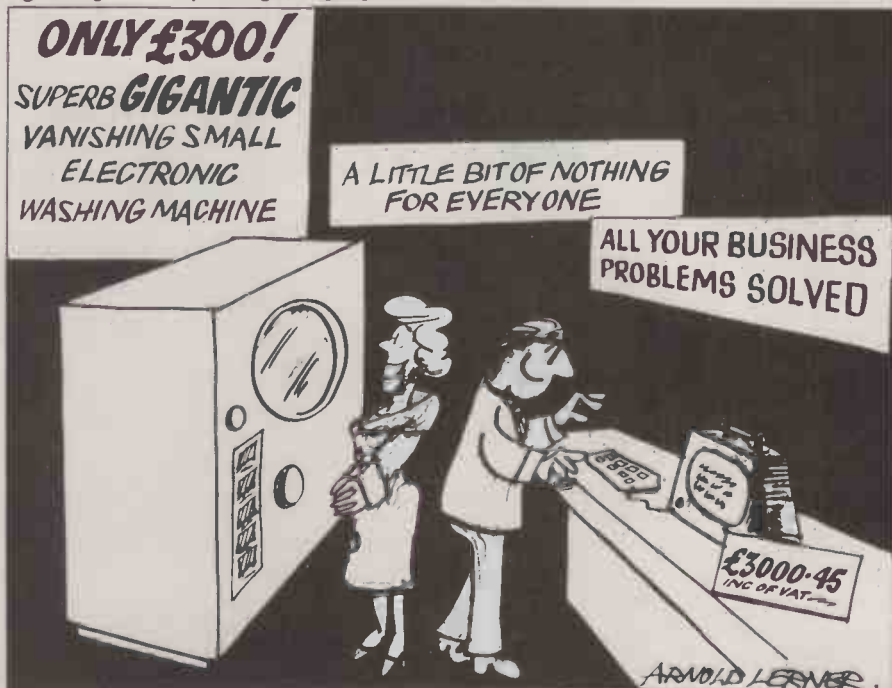

MICRODIGITAL 1980

Apple II plus



Apple II Plus will change the way you think about computers. That's because it is specifically designed to handle the day to day activities of education, business, financial planning, scientific calculation and entertainment.

- APPLESOFT
- A fast, extended 10K BASIC with 9-digit precision and graphics extensions.
- HIGH RESOLUTION GRAPHICS
- On a matrix of 280 x 192 individually addressable points.
- AUTO-START ROM
- With power on boot of applications programs, reset protection and improved screen editing.
- INTERNAL MEMORY EXPANSION TO 64K BYTES
- For big system performance at a low cost.
- EIGHT EXPANSION SLOTS
- To let the system grow with your needs

	Nett	V.A.T.	Total
Apple II Plus, 16K RAM	750.00	112.50	862.50

APPLE PASCAL

Apple Pascal is the new extension to microcomputer power. Pascal Incorporating UCSD PASCAL TM, offers extended features in a complete interactive package employing today's most sophisticated structured programming language. It provides advanced capabilities that boost performance and cut development time for large business, scientific and educational programs. This software package provides the most powerful set of tools yet available for the microcomputer programmer.

	Nett	V.A.T.	Total
Apple Pascal System	296.00	44.40	340.40

FLOPPY DISCS

Gives your system immediate access to large quantities of data. The subsystem consists of an intelligent interface card, a powerful Disk Operating System and one or two mini-floppy drives.

	Nett	V.A.T.	Total
Floppy disk Subsystem	398.00	59.70	457.70
Second disk drive and connecting cable	355.00	53.25	408.25

Parallel Printer Interface Card

Allows you to connect almost any popular printer to your Apple. A BASIC program can produce hard-copy output as easily as it prints to the TV monitor screen. Command interpretation and printer control details are handled by the firmware built into the card, to eliminate user programming requirements.

	Nett	V.A.T.	Total
Parallel Printer Interface Card	110.00	16.50	126.50

Communications Interface Card

Allows your Apple to "talk" (through a modem) with other computers and terminals over ordinary telephone and load programs over the phone, send messages to remote terminals or access your office computer from the comfort of your home.

	Nett	V.A.T.	Total
Communications Interface Card	110.00	16.50	126.50

High Speed Serial Interface Card

Allows Apple to exchange data with printers, plotters and computers in serial format at up to 19.2K Baud.

	Nett	V.A.T.	Total
High Speed Serial Interface Card	110.00	16.50	126.50

Nascom 2

Microprocessor: Z80A 8 bit CPU. This will run at 4 MHz but is selectable between 1/2/4/ MHz.

Hardware
12" x 8" Card
All bus lines are to the Nasbus specifications
All bus lines are full buffered

Memory
On-board, addressable memory:
2K Monitor - Nas-bus 1
1K Video RAM (MK4118)
1K Work space/User RAM (MK4118)
8K Microsoft Basic (MK3600 ROM)
8K Static RAM/2708 EPROM



Keyboard
New expanded 57 Key Licon solid state keyboard especially built for Nascom. Uses standard Nascom, monitor controlled, decoding.

T.V.
The T.V. Peak to peak video signal can drive a monitor directly and is also fed to the on-board modulator to drive the domestic T.V.

I/O
On-board UART (Int. 6402) which provides serial handling for the on-board cassette interface or the RS 232/20mA teletype interface. The cassette interface is Kansas City standard at either 1200 or 300 baud. This is a link operation on the Nascom-2.

PIO
There is also a totally uncommitted PIO (MK3881) giving 16, programmable, I/O lines.

Character Generator
The 1K video RAM drives a 2K ROM character generator providing the standard ASCII Character set with some additions, 128 characters in all. There is a second 2K ROM socket for an on-board graphics package which is software selectable.

	Nett	V.A.T.	Total
Nascom-2 in kit form	295.00	44.25	339.25
Power Supply	24.50	3.68	28.18
Graphics ROM	15.00	2.25	17.25

REED RELAY BOARD

Put your Nascom to work with the new Microdigital Relay Board.
16 Reed Relays, totally isolated 200 mA, 50 V.D.C. 5W max each. Operate and release time 1 ms (including bounce).
Single sided, glass fibre board, with gold plated edge connectors and silk screened component layout.

Plugs directly into Nasbus, does not interfere with normal Nascom operation, all interrupt and D.M.A. Daisy Chain Links carried on. Draws only 250 mA from each of the + and +12V Rails.
All components supplied, all ICs socketed, easy to build, and easy to program in Basic or Machine Code.
Occupies 2 consecutive ports, link selectable - several boards can be used on one Nascom system.
Output is via front edge connector on 0.1" centres. Uses standard edge connectors for connection to controlled devices.
Complete manual with sample software.

Applications
Light displays
Industrial process control
Model Railway Control
Pre programmed music generation
Robots, Central Heating Systems
Stepping Motors

	Nett	V.A.T.	Total
P.C.B. (+ Manual)	15.00	2.25	17.25
Kit	49.95	7.49	57.44
Assembled	60.00	9.00	69.00

Rockwell Aim 65

Thermal Printer
Wide 20 column printout.
Versatile 5 x 7 dot matrix format
Complete 64 - character ASCII alphanumeric format
Fast 120 lines per minute
Quiet thermal operation
Full Size Alphanumeric Keyboard
Standard 54 key, terminal-style layout
26 alphabetic characters
10 number characters
22 special characters
9 control functions
3 User-defined functions

True Alphanumeric Display
20 characters wide
16 segment characters
High contrast monolithic characters
Complete 64 - character ASCII alphanumeric format
Read/Write Memory, using R2114 Static RAM devices. Available in 1K byte and 4K byte version.
8K Monitor Program Memory, using R2332 Static ROM devices. Has sockets to accept additional 2332 ROM or 2532 PROM devices, to expand on-board Program memory up to 20K bytes.
R6532 RAM Input/Output-Timer (RIOT) combination device. Multipurpose circuit for AIM 65 Monitor functions.
Two R6522 Versatile Interface Adaptor (VIA) devices, which support AIM65 and user functions

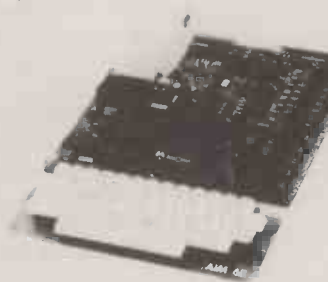

	Nett	V.A.T.	Total
AIM-65 with 1K	249.50	37.43	286.93
AIM-65 with 4K	315.00	47.25	362.25
8K BASIC ROM	70.00	10.50	80.50
4K ASSEMBLER ROM	59.50	8.93	68.43
CASE (includes P.S.U.)	78.00	11.70	89.70
P.S.U.	41.63	6.27	48.10
MOTHERBOARD	136.50	20.48	156.98

Sharp

SHARP MZ-80K
Z-80 based CPU.
4K Byte monitor in ROM.
Internal memory capacity from 4 to 48K RAM.
14K Extended BASIC.
10 in video display, 40 chars. of 24 lines.
80 x 50 bit mapped graphics.
Extensive character set with upper, lower case, graphics etc.
Full 79 Key Keyboard.
Built in music synthesizer with 3 octaves.
Fast reliable cassette unit with tape counter 1200 b.p.s.
Wide variety of system software on cassette.
50 pin bus connector for system expansion.



A complete personal computer system for the microcomputer user, at an economic price. The Sharp comes complete with all necessary peripherals, sample software and excellent documentation - giving the user a personal system of unmatched flexibility and ease of use. At the heart of the machine is the Z-80 CPU - widely accepted as the most powerful 8-bit CPU on the market. A 4K byte system monitor controls system operation. From 4 to 48K of RAM can be resident on board; enough room for the most demanding applications.

An extensive graphics character set, plus 3 octave sound generator and fast cassette unit hi-resolution video monitor complement these basic facilities. It has the ease of use and compactness of "black box" computer combined with extensive peripherals and facilities for expansion. Sharp Basic occupies 14K of RAM; and offers extended features above those of normal microcomputer implementations.

Model	Nett	V.A.T.	Total
6K	520.00	78.00	598.00
10K	540.00	81.00	621.00
16K	640.00	93.00	713.00
22K	640.00	96.00	736.00
34K	740.00	111.00	851.00

Acorn



This compact stand-alone micro-computer is based on Eurocard modules, and employs the highly popular 6502 MPU. Take a look at the full specifications, and see how Acorn meets your requirements.

The Acorn consists of two single Eurocards:
1. MPU card; 6502 microprocessor, 512 x 8 ACORN Monitor; 1K x 8 RAM; 15-way I/O with 128 bytes of RAM; 1 MHz crystal; 5V req sockets for 2K EPROM and second RAM I/O chip.
2. Keyboard card; 25 click-keys (16 hex, 9 control); 8 digit, 7 segment display. CUTS standard crystal controlled tape interface circuitry.

Acorn Operating Manual
With Acorn, you'll receive an operating manual that covers computing in full, from first principles of binary arithmetic, to efficient hex programming with the 6502 instruction set. The manual also includes a listing of the monitor programs and the instruction set, and other useful tabulations; plus sample programs.

	Nett	V.A.T.	Total
Kit	65.00	9.75	74.75
Ready Built	75.00	11.25	86.25

Acorn Memory
A high quality fibre glass, through hole plated, PCB with solder resist and component identification, this eurocard has provision for 8K of RAM (2114) and 8K of EPROM (2732).

	Nett	V.A.T.	Total
8K RAM (Kit)	95.00	14.25	109.25

ACORN V.D.U.
The Acorn V.D.U. Board connects to the Acorn Computer Bus and contains memory mapped character storage RAM which is transparently written to or read from, by the C.P.U.

An MC 6845 programmable controller I.C. Provides all the synchronisation signals to drive a 625 line 50 fields per second V.D.U. together with read addresses for the character R.A.M. Characters are then fed to an SAA 5050 character generator IC which produces the necessary dot patterns to create the characters to refresh the V.D.U.

The SAA 5050 produces Teletext standard characters and has Red, Green and Blue drive outputs giving coloured characters or graphics.

	Nett	V.A.T.	Total
V.D.U. Card (Kit)	88.00	13.20	101.20

Apple Computer Sales and Service

Bigger and better than ever!

Commodore Superboard II Pet



The sensational single-board computer from Ohio Scientific. Full 8K BASIC on ROM, video interface with extensive graphics character set, ACSII keyboard, 4K RAM and full facilities for expansion. Superboard comes fully assembled and tested, with documentation and sample programs on cassette.

	Nett	V.A.T	Total
Superboard II ..	188.00	28.20	216.20

Media

Microdigital are famous for their high quality, low cost magnetic media.

	Nett	V.A.T	Total
C15 cassettes (box of 10 in library cases) ...	4.40	0.66	5.06
5" Single density, single sided minifloppy	2.00	0.30	2.30

Q.E.D. Mains Suppressor

Cure the problems associated with mains borne interference and your microcomputer. Eliminates most problems with fridges, lifts, and other inductive loads.

	Nett	V.A.T	Total
Q.E.D. Suppressor	10.83	1.62	12.45

Hire

Avoid an expensive mistake ... Microdigital (hire) lets you evaluate a potential machine at low cost. Both long and short term charges, a wide range of machines, and the backup service for which we are famous, make this the finest hire service available in the U.K. Contact Malcolm Helsby on 051-227 2535 for further details.

MICRODIGITAL

25 Brunswick Street, Liverpool L2 0PJ Mail orders to: MICRODIGITAL LIMITED, Tel: 051-236 0707 (24 Hour Mail Order) FREEPOST (No Stamp Required) 051-227 2535/6/7/8 (All other Depts.) Liverpool L2 2AB.

The Mighty Microdigital

Microdigital are one of the largest and longest established Microcomputer firms in Europe. We sell a wide range of systems, backed up by support services that are second to none. Our present retail outlet is at 25 Brunswick Street, Liverpool. Our well informed staff are happy to demonstrate equipment, provide technical help, or just chat. Microdigital (mail order) is the fastest, friendliest and most efficient mail order service available. All orders (for an acknowledgement if the goods are temporarily out of stock) are despatched by return post. Telephone orders are welcome (24 hours a day) and we even have a "Freepost" service so you don't have to remember the stamp! Microdigital Manufacturing is our hardware department. We carry out repairs and servicing in-house rather than depending on the manufacturer. In addition we design and manufacture our own peripheral boards for the systems we support. Custom design services are also available.

Microdigital (Software) is responsible for the development of commercial, high quality, computer programs. We can advise on the suitability of an existing package, modify the package, or write a completely new system to the customers specification. Microdital (Hire) provides a service for potential customers — the capabilities of a particular machine can be evaluated without a substantial capital investment. All in all we try and provide the most competent service in the Microcomputer industry.

The Microcomputer shop providing a complete service from a single chip to a data processing installation. Opening hours: 9 - 5.30 Mondays to Saturday Friendly, expert staff always on hand.

Our new, glossy, 16 page brochure is now the talk of the industry! — Send for your free copy today.



Microdigital Software Announce

5 packages which are:

General Ledger	£295.00
Purchase Ledger	£295.00
Sales Ledger	£295.00
Stock Control	£200.00
Payroll	£360.00

These packages are now available, demonstrations on request. Ring 051-227 2535 and ask for Graham Jones (Software Manager). These are fully tested systems which run on the Apple/ITT 2020 with one or two disc drives. The Stock Control package can handle up to 1250 stock items and uses two disc drives.

Liverpool Software Gazette

Britain's very first journal for Micro Software. Review, tutorials, news ... PET, Apple columns, keep yourself informed with the latest trends in Microcomputing.



ONLY 50p PER COPY

Please subscribe the next 12 issues of "Liverpool Software Gazette" I enclose cheque/ PO for £6.00

Access No _____
 Barclaycard No. _____
 Name _____
 Organisation _____
 Address _____
 Post Code _____

Mail to: Microdigital Ltd. FREEPOST (No Stamp Required), Liverpool L2 2AB.

A complete Computer for the price of a good typewriter! With a library of over 200 programs in business, science, education and entertainment. Pet can store and retrieve data which conveniently occupies large storage capacity, and solve numerical problems traditionally tedious and time consuming.

Ease of Operation The Commodore PET comes complete with a built-in T.V. screen, and keyboard as well as its full computer circuitry. It is plugged into any 13 amp and no special computer knowledge is needed for running standard programs. Personal programs can readily be written in the BASIC computer language of PET which is easily learned.

An Expandable System Further expansion is a prime design concept enabling PET to be made the heart of a much larger system incorporating printers, floppy discs etc., as and when required.

Computers PET 2001-8 — PET with integral cassette and calculator type keyboard. 8K bytes memory.

PET 2001-16N — PET with 16K bytes memory and large keyboard. External cassette optional.

PET 2001-32N — PET with 32K bytes memory and large keyboard. External cassette optional.

Computhink Disk Units 400K Random for 8K Pet 795.00 119.25 914.25 400K Random for New Pet 2 840.00 126.00 966.00 800K Random for New Pet 2 995.00 149.25 1,144.25

Phone in your Access/Barclaycard Number on 051-236 0707 or complete this order form



25 Brunswick Street, Liverpool L2 0PJ Tel: 051-236 0707 (24 Hour Mail Order) 051-227 2535/6/7/8 (All other Depts.)

Please Send Me: _____

 I Enclose: Cheque/Postal Order No. _____
 Barclaycard No. _____ Access No. _____
 Name _____
 Address _____
 Post Code _____

• Circle No. 188

• Circle No. 189

“The cheapest most advanced business Microcomputer”

... says Michael Korns of Computhink.



ACT series 800 from only... £19.45 p.w.*

*5 year lease. Shorter terms available.

The next generation computer system built in California by Computhink and backed by Britain's leading computing company, ACT.

The ACT Series 800 features lightning fast processing capabilities and unequalled data retrieval speed. It is upwardly compatible with the PET.

In addition to brilliant High Resolution Graphics the ACT Series 800 has the most advanced full screen data entry and editing capabilities ever made available on a micro-computer.

Nebula fully integrated software packages written in Britain by ACT include Sales Ledger and Invoicing, Purchase Ledger, Payroll, Stock Control and Word Processing. Plus over fifty more program titles.

ACT 808 with 800,000 characters of on-line disk storage, £3,950 + VAT.

ACT 824 with 2,400,000 characters of on-line disk storage, £4,950 + VAT.

Prices correct at time of going to press.

PET is the trademark of Commodore.

ACT series 800

Complete the coupon for full details and the name of your nearest dealer who can arrange an immediate demonstration.

My Name _____

My Address _____

Tel: _____

ACT
MICROSYSTEMS

Total Computing

Radclyffe House,
66-68 Hagley Road,
Edgbaston,
Birmingham B16 8PF.
Tel: 021-455 8686
Telex: 339396

Try the ACT 800 series computer at one of these dealers now:

LONDON
Lion House (Retail) Ltd.
227 Tottenham Court Road, London W1P 0HX
Tel: 01-580 7383

THE SOUTH
Petalect Electronic Services
32 Chertsey Road, Woking, Surrey
Tel: 04862-21776/23637

Business Electronics
Rownhams House, Rownhams, Southampton
Tel: 0703-734015

RUF Computers
System House, Victoria Way, Burgess Hill, W. Sussex
Tel: 04446-45211

T & V Johnson (Microcomputers) Ltd.
165 London Road, Camberley, Surrey
Tel: 0276-62506

South East Computers Ltd.
4 Castle Street, Hastings, Sussex
Tel: 0424-440099

SOUTH EAST
Senodisk Ltd.
34-36 St. Helens Road, Westcliff-on-Sea, Essex
Tel: 0702-352590

The Computerist (Prorole Ltd.)
642 London Road
Westcliff-on-Sea
Essex
Tel: 0702-335298

SOUTH WEST
ACT Bristol Ltd.
Graphic House, Telephone Avenue, Bristol BS1 4BS
Tel: 0272-211733

EAST MIDLANDS
HB Computers
22 Newland Street, Kettering, Northants.
Tel: 0536-520910/83922

Low Electronics Ltd.
Chesterfield Road, Matlock, Derbyshire DE4 3HE
Tel: 0629-28172430

Arden Data Processing Ltd.
Municipal Buildings, Charles Street, Leicester
Tel: 0533-22255

Office Computer Techniques (Middletron)
Highcroft, Husbands Bosworth, Lutterworth, Leics.

MMS (Steenmoor) Ltd.
26 Mill Street, Bedford, Beds.
Tel: 0234-40601

Caddis Computer Systems
72-74 Trinity Lane, Hinckley, Leics.
Tel: 0455-613544

A. J.R. (Office Equipment) Ltd.
5 Church Drive, Daybrooke, Nottingham NE5 6JP
Tel: 0602-206647

Hallam Computer Systems
1 Berkeley Precinct, 451 Eccleshall Road,
Sheffield S11 8PN
Tel: 0742-663125

EAST ANGLIA
Sumlock Bondain (East Anglia) Ltd.
Grosvenor House, 32 Prince of Wales Road,
Norwich, Norfolk
Tel: 0603-26259

WEST MIDLANDS
Taylor Wilson Systems Ltd.
Oakfield House, Station Road, Dorridge,
W. Midlands B93 8HQ
Tel: 021-560 6192

MERSEYSIDE
Stack Computer Services Ltd.
290-298 Derby Road, Bootle, Merseyside L20 8LN
Tel: 051-933 5511

D.A.M.S. (Office Equipment) Ltd.
30-36 Dale Street, Liverpool 2
Tel: 051-227 3301

Aughton Automation Ltd.
Woodward Road, Kirby, Liverpool 2
Tel: 051-548 6060

MANCHESTER
Cytek U.K. Ltd.
12 Exchange Hall, Corn Exchange Building,
Manchester M4 3EY
Tel: 061-832 7604

SCOTLAND
Robox Office Equipment Ltd.
Unit 14, Anderson Shopping Centre, Argyll Street,
Glasgow G2 7PH
Tel: 041-221 5401

In Space, no-one can hear you think

Blake7: A space battle game against a simulated enemy. By D. N. Sands

UNLIKE Startrek and similar games for smaller systems, this program has no graphics. The relative positions and speeds of your craft and the enemy craft are presented entirely numerically and in three dimensions, requiring some intelligence and imagination to visualise the actual situation in the void.

The program uses Newtonian physics and this, too, is difficult for some people to grasp. For example, turning your ship about has no effect at all until you fire your rockets.

Some people turn on the rockets and leave them on, resulting in colossal speeds, forgetting that in space there is no friction and you do not need power just to maintain a speed.

Figures are given for three axes.

X-axis: left is minus X, right is plus X.

Y-axis: up is plus Y, down is minus Y.

Z-axis: front is plus Z, back is minus Z.

If the relative position of the enemy (displacement) on the Z-axis is positive, but his relative velocity is negative, then he is in front of you and closing. Additionally, he has components of displacement and velocity in the other two axes.

For clarity the computer also tells you the distance measured directly between the two craft and the true relative speed, ie rate of change of this distance.

If the two craft were side-by-side going in the same direction and one were going faster than the other, the true relative speed would be zero at that time because the two craft are neither closing nor parting.

Also the approach angle measured from the Z-axis, amount of fuel etc — see listing 2.

This is the captain of your ship

The operator is the ship's captain and issues commands to control speed and direction, laser guns, protective shield and fuel regeneration. After each command, the situation is presented as it would be after ten seconds. All data is metric and is realistic.

The program is designed so that the enemy tries to close in smoothly, decelerating at the right time in order to be at low speed when very close in order to board your spacecraft.

Actually it doesn't work too well because my integration algorithm only uses ten-second increments and other

shortcomings, but in practice you wouldn't just sit there and the whole dynamic situation is altered by your own movements, and also laser damage which affects rocket efficiency. Damage to both craft is gradually repaired.

When the program starts, it asks for a random number seed 0-9 then for a value (QO) for enemy strength. Enter one for this latter value the first few times you play. If the enemy is losing a laser battle he tried to get away (see line 5405). At this point his rockets are damaged and you can finish him off easily with QO = 1.

With QO = 10 he gets away too easily and it is very difficult to keep up with him as he is constantly changing direction. Then there are two half-pages of instructions and a request for amount of fuel 0-1000 litres. This is another value then can be reduced to make the game harder. Fuel is a limiting factor in a chase. See listing 1.

Entering the program (see listing)

This program is written in North Star Basic but can be easily converted to Microsoft or other Basic. The following should be noted:—

1. If you don't have ELSE then leave off that part and insert one line after an unconditional goto, or for a variable alteration put an unconditional statement one line before.
2. Exclamation mark is North Star shout for PRINT. Microsoft, use question mark.
3. When entering the program take great care. Unlike other Basic listings, this one is next to pure gibberish. If it doesn't work, check every line again, or get someone else to check it. It has been thoroughly tested by many players and works well. I have also written it in Microsoft Basic and proved it works in that as well.
4. The OUT instruction is an optional screen clear for the author's system.
5. If you have North Star and are stuck, then send me a well packed disk with a file ready, 20 blocks long, called BLAKE7, plus stamps for return postage.

**D. N. Sands,
Sands Whiteley Research and
Development,
Cambridge Road,
Orwell, Royston,
Herts.**

• Circle No. 190

```

5 REM 'BLAKE7' SIMULATION GAME
6 REM D.N.SANDBS 1979
10 P=3.14159
20 INPUT"ENTER RND SEED 0-9: ",F
30 F=RND(F/10)
40 OUT134,12\REM CLEAR SCREEN
50 INPUT"ENTER ENEMY STRENGTH, 0-5 : ",Q0
100 !"BLAKE'S 7"
110 !"YOU ARE IN A SPACECRAFT AND AN ENEMY CRAFT IS DETECTED."
120 !"IF THE ENEMY GETS TO CLOSE HE WILL DETECT YOU AND TRY TO ATTA
CK."
130 !"YOU THEN HAVE THE CHOICE OF TRYING TO ESCAPE OR TO RETALIATE.
"
140 !"YOUR COMPUTER CAN GIVE YOU THE STATUS OF BOTH CRAFT"
150 !"AND YOU ALSO CONTROL YOUR CRAFT AND WEAPONS THROUGH"
160 !"THE KEYBOARD WITH A REPERTOIRE OF COMMANDS."
170 !"THE COMPUTER WILL INFORM YOU OF MAJOR CHANGES IN STATUS"\!\!
190 INPUT"ARE YOU READY TO PROCEED? ",C$
200 OUT 134,12
210 !"YOU MAY DEMAND INFORMATION AS FOLLOWS!—"
220 !" 'DATA' GIVES SPEEDS OF BOTH CRAFT, PLUS VECTORS X,Y,Z ETC."
260 !" 'POWER' THEN A VALUE 0 TO 1000 SETS YOUR ACCELERATION"
270 !" 'TURN' CHANGES YOUR ORIENTATION! FOLLOW WITH +OR- X,Y OR Z"
280 !"REMEMBER THIS DOES NOT CHANGE YOUR DIRECTION WITHOUT POWER ON
"
285 !" 'ATTACK' ATTACKS THE ENEMY WITH LASER WEAPON."
286 !" 'SHIELD' TOGGLES LASER SHIELD BUT USES FUEL TO MAINTAIN"
290 !" 'REGEN' REGENERATES FUEL SUPPLY"
292 !"HIT RETURN TO REPEAT LAST COMMAND."
295 !"AT EACH COMMAND TIME IS ADVACED BY 10 SECONDS"
300 INPUT"ARE YOU READY TO PROCEED? ",C$
310 IF C$="NO"THEN100
320 X=INT(RND(0)*20000)-10000
330 Y=INT(RND(0)*20000)-10000
340 Z=INT(RND(0)*190000)-95000
345 U2=0\U2=0\W2=INT(RND(0)*100)
350 D=99000\U1=0\U1=0\W1=100\H1=0\F2=.001\F1=0\D$="+Z"\H2=0
355 INPUT"ENTER AMOUNT OF FUEL REQUIRED 0-1000 ",F
356 IF F>1000 THEN 355
360 OUT 134,12
370 !"YOU ARE PROCEEDING AT 100 M/SEC IN DIRECTION Z"
375 !"YOU HAVE",F," LITRES OF FUEL AND YOUR MOTORS ARE OFF"
380 FOR Q=0 TO 2000\NEXT\OUT 134,12
390 PRINT"ENEMY CRAFT DETECTED!"
395 S0=-1
400 GOSUB 5000
420 INPUT"COMMAND? ",C$
430 IF LEN(C$)=0 THEN C$=C1$\REM SO THAT RETURN ONLY
431 REM REPEATS LAST COMMAND
435 C1$=C$
440 IF C$="ATTACK"THEN5500
450 IF C$="REGEN"THEN 600
460 IF C$="POWER"THEN1200
480 IF C$(1,4)="TURN"THEN1300\REM OR 'LEFT$(C$,4)'
490 IF C$="DATA"THEN 400
495 IF C$="SHIELD"THEN 510
500 PRINT\GOTO 400
510 S0=S0*-1\C1$="DATA"
520 GOTO400
600 F=F+25\GOTO400

```

Thinking Computers?



Then come to the number one micro-computer centre

If you're wondering if a micro-computer can help you, we are here to advise you. At Lion House—London's leading centre for micro-computers—you'll find:

- * Experts who'll explain the equipment in a way you can easily understand, showing how and where it applies to *your* work.
- * Demonstration areas where you can get immediate experience of using micro-computers yourself.
- * Probably the biggest range of software in the UK.
- * Programmes can be tailored for your particular commercial needs by our In-House Analysts and Programmers.
- * Total service—including the availability of full maintenance after you've bought an installation.
- * Leasing and H.P. facilities immediately available.
- * A computer book section with publications that give you new insight into the world of micro-computers.

How will micro-computers help you? In thousands of ways—only a few can be mentioned here...

MICRO-COMPUTERS FOR BUSINESS



For business and professional, the versatility of compact micro-computers means that all the benefits of big computers are made available to all at low cost. The businessman can now computerise his accountancy, his stock control, his records and much more—cutting his overheads and improving his efficiency.

For the home, micro-computers have innumerable uses and considerable value too—sometimes in unexpected ways.

MICRO-COMPUTERS FOR THE HOME



Budgeting... investments... controlling heating or security... storing information on things like recipes... designing complex and fascinating games... education...

Come and see. We invite you to visit us and investigate the possibilities and the potential. If you're too far away, phone or write and we'll send you more information. **You need a micro-computer.** We can supply it.



LION MICRO-COMPUTERS

SMALL COMPUTERS—TO MAKE YOUR BUSINESS BIGGER

Lion Computer Shops Ltd, Lion House, 227 Tottenham Court Road, London W1 (First Floor). Telephone: 01-637 1601.

Telex: 28394 Lion G.

Open 9 to 6, Monday to Saturday (Thursday to 7).



```

1100 PRINT "YOUR FUEL",F," LITRES, POWER=",P1," ",D$,
1110 IF S0>0 THEN PRINT"SHIELD ON",
1120 PRINT
1130 RETURN
1200 INPUT"HOW MUCH POWER 0-1000? ",P1
1205 IF (P1>1000 )OR(P1<0 )THEN1200
1210 C1$="DATA"
1220 GOTO 400
1300 D$=C$(5,6)
1320 GOTO400
5000 REM RECALC ALL PARAMS FOR NEXT 10SEC
5002 IF D<500THEN5800
5003 N=10
5005 IF D<10000THEN5400
5010 IF D<90000THEN 5040
5020 IF D<100000THEN5070
5030 PRINT "ENEMY CRAFT NOW OUT OF RANGE"\NEND
5040 PRINT "YOU ARE IN ENEMY RADAR"
5060 P2=500
5070 IF D$="+X"THEN U1=U1+P1/5*(1-H1/10)
5080 IF D$="-X"THEN U1=U1-P1/5*(1-H1/10)
5090 IF D$="+Y"THEN V1=V1+P1/5*(1-H1/10)
5100 IF D$="-Y"THEN V1=V1-P1/5*(1-H1/10)
5110 IF D$="+Z"THEN W1=W1+P1/5*(1-H1/10)
5120 IF D$="-Z"THEN W1=W1-P1/5*(1-H1/10)
5130 F=F-P1/100
5135 IF S0>0THEN F=F-50
5140 IF F>0 THEN 5170
5150 P1=0\F=0\S0=-1
5160 PRINT "OUT OF FUEL!"
5165 GOSUB1100
5170 PRINT"          YOUR SPEEDS:- X:",INT(U1)," Y:",INT(V1)," Z:",I
NT(W1)
5180 H1=INT(H1*9.9)/10
5200 REM POLAR POSITIONING(RELATIVE)
5210 G=ABS(U0-X)+ABS(V0-Y)+ABS(W0-Z)
5220 A0=G((X^2+Y^2)^.5/Z)
5230 H2=INT(H2*9.9)/10
5240 A=(U0-X)/G*P2/50*(1-H2/10)
5242 IF ABS(X)<ABS(U0^2/A)THEN A=A*2*SGN(U0)*SGN(X)
5245 U2=U2+10*A\U0=U2-U1\X=X+U0*10
5250 B=(V0-Y)/G*P2/50*(1-H2/10)
5252 IF ABS(Y)<ABS(V0^2/B)THEN B=2*B*SGN(V0)*SGN(Y)
5255 V2=V2+10*B\V0=V2-V1\Y=Y+V0*10
5260 C=(W0-Z)/G*P2/50*(1-H2/10)
5262 IF ABS(Z)<ABS(W0^2/C)THEN C=2*C*SGN(W0)*SGN(Z)
5265 W2=W2+10*C\W0=W2-W1\Z=Z+W0*10
5270 REM RELATIVE SPEED&DIST
5275 A0=ABS(A0)
5280 S=U0*SIN(A0)*SGN(X)+V0*SIN(A0)*SGN(Y)+W0*COS(A0)*SGN(Z)
5290 D=SQRT(SQRT(X^2+Y^2)^2+Z^2)
5300 PRINT"  ENEMY CRAFT SPEEDS:- X:",INT(U2)," Y:",INT(V2)," Z:",I
NT(W2)
5310 PRINT"ENEMY CRAFT REL. POSN. X:",INT(X)," Y:",INT(Y)," Z:",INT
(Z)
5320 PRINT"REL. SPEED=",INT(S)," DISTANCE",INT(D),
5325 PRINT" APPROACH ANGLE",INT(A0*180/P)," DEGS"
5330 GOSUB 1100
5335 IF N<6THENP1=0
5340 RETURN
5400 P2=(INT(D/100))+10*5
5405 IF (H2>H1)AND(H2>5)THEN P2=P2*-Q0

```

```

5410 PRINT"YOU ARE UNDER LASER ATTACK: ",
5415 IF S0=1THEN5460
5420 H=1000/(RND(0)*D)
5430 IF H<.5 THEN5460
5440 PRINT" YOU HAVE BEEN HIT",
5450 H1=H1+1
5455 IF H1>10 THEN 6000
5460 PRINT" DAMAGE FACTOR ",H1,\NGOTO5070
5500 H=1000/(RND(0)*D)
5502 IF D<500 THEN 5560
5503 IF H1>=9.5THEN5570
5505 IF F<10 THEN 5700 ELSE F=F-10
5510 IF H<.5 THEN 5550
5520 H2=H2+1
5530 IF H2>10THEN5600
5540 PRINT"A HIT, DAMAGE FACTOR ",H2\NGOTO400
5550 PRINT"MISSED: DAMAGE FACTOR ",H2\NGOTO 400
5560 PRINT"TOO CLOSE: COMMAND IGNORED"\NGOTO 400
5570 PRINT"LASERS INOPERATIVE"\NGOTO 400
5600 PRINT"YOU HAVE KNOCKED OUT THE ENEMY"\END
5700 PRINT"SORRY, NO FUEL."
5710 GOTO400
5800 N=N-1\!"ENEMY TRYING TO BOARD"
5810 IFN>8THEN5070
5820 PRINT"ENEMY BOARDING"
5830 IF N>7 THEN5070
5840 PRINT"UNAUTHORISED PERSONELL IN ENGINE ROOM"
5850 IF N>6THEN5070
5855 PRINT"ENGINES UNDER ENEMY CONTROL-RESET POWER"
5860 IF N>1THEN5070
5870 PRINT"YOUR CRAFT UNDER ENEMY CONTROL"
5880 END
6000 PRINT"--YOU ARE IMMOBILISED"\H1=10\NGOTO5070
READY

```

M

HOTEL SYSTEM for 32K & CBM DISK £495 inc

CBM PET**ROOM AVAILABILITY SYSTEM**

The system provides immediate viewing and booking for upto 8 blocks of rooms for 400 days ahead. Each block can contain upto 99 rooms. The theoretical capacity is therefore 792 rooms. The room blocks are initially defined and named by the user. The program automatically advances the 400 day period as the date progresses. The large capacity of the system means it is suitable for a small group of hotels or any similar type of use.

On entering a date the screen shows the availability within all the blocks for that date - plus the following six days. Without entering a date it can immediately be stepped forward or backward in 7 day steps. The screen automatically shows the day of the week for the date entered and deals automatically with leap years. In addition, a perpetual calendar is on instant call.

GUEST BILLING SYSTEM

The program caters for upto 130 rooms and makes invoicing of guests for their accommodation and for any other services extremely easy. The guests account is called at any time simply by entering their room number. Any service is entered by pressing an appropriate key and then the amount. Final accounts when called for, automatically itemises services and charges and includes VAT and service charges.

The two systems are integrated as one program but the ROOM AVAILABILITY SYSTEM may be purchased as a separate program for £275.

PAYROLL for 16K or 32K & CBM DISK or COMPU-THINK £95 inc

An easy to use, efficient and very 'user friendly' payroll program. It is so well prompted that it can almost be used without a manual - there is one, of course. It avoids the problem of having to print on double paper by printing the payslip and copy side by side. Thus, the employers copy can still remain in a continuous sheet. It is written to the Inland Revenue Specification for computerised payrolls. Coverage: ALL Tax Codes, ALL NI Codes. Hourly, Weekly and Monthly paid staff mixed on the same disk file. 3 Rates of Overtime. 5 Pre-Tax Adjustments with Alpha. 5 After-Tax Adjustments with Alpha. Cash Analysis. Can run without a printer. On 32K will handle about 250 employees. On 16K will handle about 50 employees. Update service at reasonable charge.

LANDSLER SOFTWARE

29A TOLWORTH PARK ROAD SURBITON SURREY KT6 7RL 399 2476

Nuts and bolts fix for the learning process

J. A. M. Howe investigates the practical and philosophical problems of teaching children by model building.

TWENTY YEARS ago, educationists had such an impoverished understanding of human learning processes that they expected to replace teachers with machines within a decade. Today, we are more aware of the deep pedagogical problems that would have to be solved before this task could be accomplished.

For example, when a pupil flounders around unable to start on a new problem, what should the machine do? It wouldn't want to give the game away, so it would wish to hint rather than direct. But how are these hints generated and evaluated? Again, if a pupil gets stuck in the middle of a problem, the system would need to interpret what he had done and provide assistance in tune with the pupil's thinking.

If his difficulty is due to an early error, ought the system to have allowed him to carry on regardless, or ought it to have interrupted his work when the error was made? Indeed, if the error was hidden because the relevant working was not shown to the system, how would the system figure out sensible questions which might reveal basic misconceptions? Given these kinds of pedagogical problems, and financial considerations and the teacher's traditional dislike of machines in the classroom, we can confidently anticipate that expert systems in the shape of computerised tutors will play a minor role in education for many years to come.

So instead of talking about expert systems, we want to talk about systems which experts, ie teachers, can use as a resource to help them achieve their objectives, eg teach maths, physics, literary style, and so on. The notion, which will become clearer in due course, is to use the computer to simulate a modelling system which a learner can use to carry out model-building experiments.

Building physical models

When the average person hears the word "model", he probably thinks of the kits of parts from which children assemble miniature plastic replicas of aeroplanes, space ships, buildings and a host of other familiar objects. For the moment, we will take advantage of this association to begin our discussion of model building.

Since a toy model captures the essential form of an object, it is a pleasing representation of its *structure*. But a child can also buy the finished product, so why does he bother with a kit of parts? Almost

certainly the answer is that he enjoys the activity of assembling the model.

Indeed, a child is often more interested in grappling with the problems of assembling the object from its parts than he is in playing with the final product. What he is engaged in is learning the process of model assembly, which involves such skills as identifying parts and their relationships, and ordering the assembly sequence.

But besides learning to assemble models which represents familiar structures, the child can also learn to assemble models which represent mechanisms. Here we refer to models which simulate mechanisms such as the steering systems in a car or the actuating system for flaps and rudder in an aeroplane.

The advantages of working with these representations of real world mechanisms are two-fold. First of all, working models

are more compelling as simulations of reality and secondly the child might come to understand the general principles underlying the mechanisms. Of course, the latter cannot be assumed since a child might simply follow assembly instructions in an unthinking way.

To promote real understanding of mechanisms, there is a need for a modelling system which allows a child to be creative. It should provide him with an opportunity to alter pre-determined models, and even to create his very own models. What we are talking about now is a very different kind of kit of parts: instead of a set of particular components needed to assemble a particular object, we need a set of general purpose components in terms of which a child can conceive a design and execute it.

An example of such a kit of parts would be a collection of electronic components.

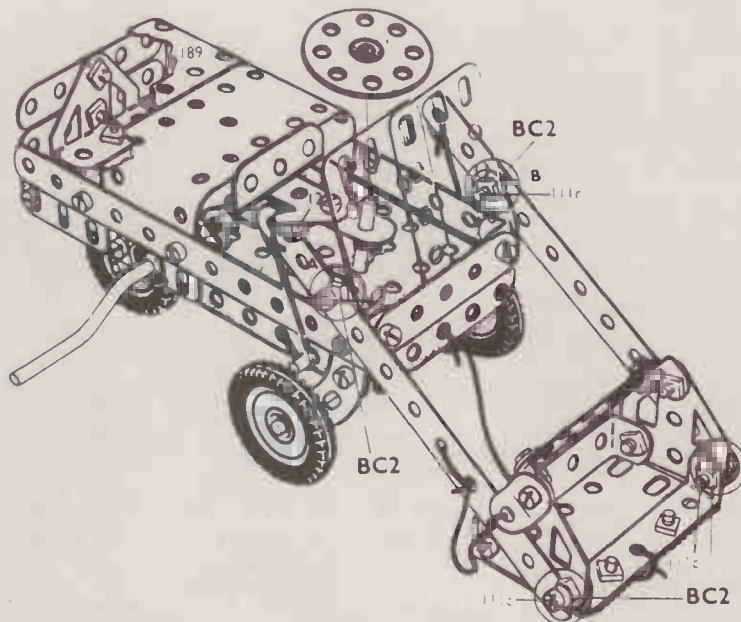

The learner has to be led skilfully through 'models' of increasing complexity. Here, for example, are excellent examples taken from the now unhappily defunct Mecanno range. Both figures show bump trucks. Above is a novice's, on the right is the expert's version of the same idea.

These could be assembled into working circuits to a child's own design, given enough knowledge of electronic circuit principles and access to facilities to test the characteristics of the circuits at various intermediate points, since all but their final behaviour is hidden from view.

Another example which may be more comfortable for many of you is a mechanical construction set, called Meccano. It comprises a collection of perforated metal strips, plates, brackets, wheels, axles and gearwheels, and so on, which can be bolted together to form models. To the uninitiated, a box of Meccano parts is a bewildering collection of pieces of metal. Give such a box to a novice without instructions and he can make little sense of the parts: the models which he builds are unstable and the working mechanisms usually stop working as soon as they are run.

The point is that learning to use Meccano creatively and successfully involves a long period of apprenticeship. The size of the task becomes clearer when we identify what a child has to know.

1. He has to become completely familiar with the full range of components, eg strips, plates, tubes, axles, gearwheels, brackets.
2. He has to learn the basic operations for assembling components to form models, eg making measurements,

establishing correct relationships between the parts, and so on.

3. He has to understand the structure and the mechanism used in the machine he wants to model so that he can represent their essential features, eg the structure of a mechanical grab and its winding gear.
4. To represent these structures and mechanisms successfully in Meccano, he has to learn to apply important general knowledge about mechanical construction, eg the importance of triangular bracing, the use of plates to provide stiffening, the need for standardisation of parts for interchangeability, the need for alignment parts (tolerance), the need to minimise friction, and so on.
5. He also has to learn how to plan an assembly sequence, involving breaking down the object into a set of sub-parts, eg chassis, suspension, steering gear, final transmission, gearbox, engine, body, etc which can be separately assembled but which are subject to mutual constraints when brought together.
6. Finally, he has to learn to cope with any mismatches which occur between the plan and its execution in terms of the available components, making modifications to overcome problems not anticipated in the design.

So learning to use Meccano creatively is a formidable undertaking, requiring a great deal of time and a great deal of help and guidance. But the manufacturers realised this situation; they organised the teaching most carefully. First of all, they designed a series of Meccano models of objects such as cars, cranes, bridges, and so on, which ranged from very simple models made from a few components which were but sketchy representations of the real objects, to highly elaborate models, made out of many hundreds of components, which could simulate a working system.

Graded difficulty

Next, they graded these projects into 10 levels of difficulty and made up 10 standard sets of components which could be used to assemble all the objects encompassed by a particular level of difficulty provided the detailed assembly instructions were followed. The manufacturer also provided conversion kits, containing the components necessary to increment from one level to the next one up.

We can see that their teaching strategy was to match the projects to a child's level of expertise in assembly, beginning with a small set of components and a few simple tasks and gradually widening the scope. Such an approach provides the kind of

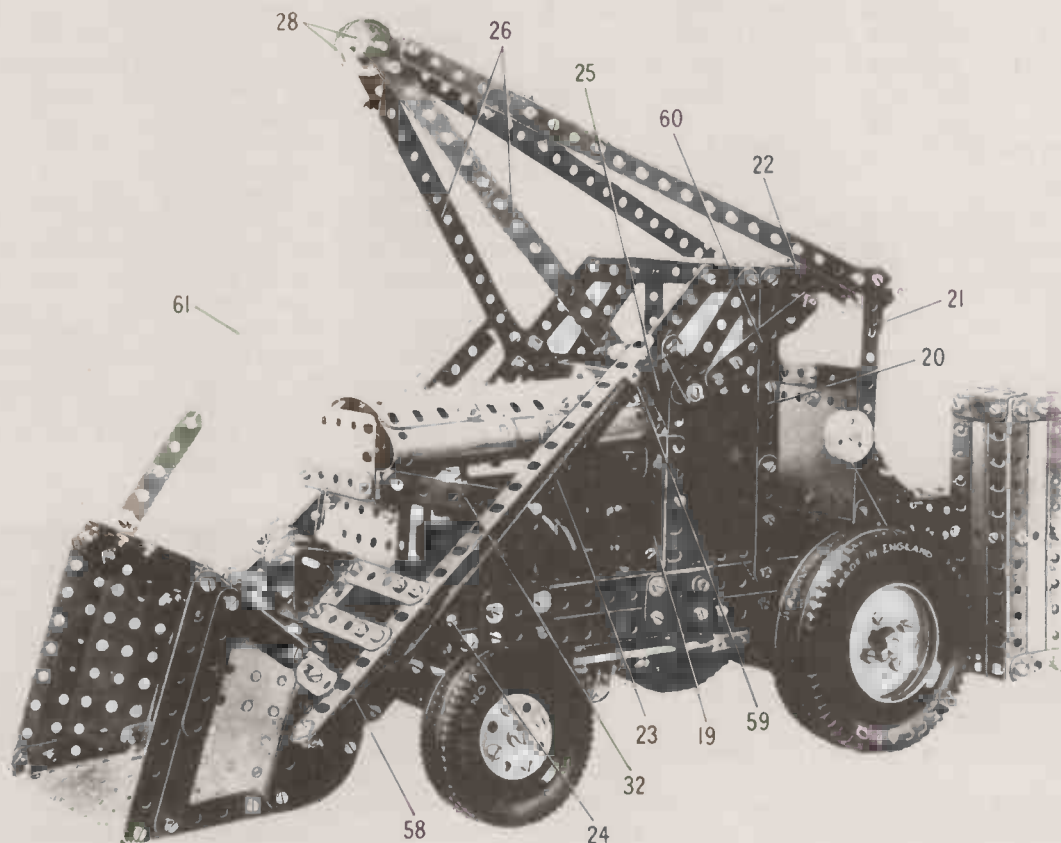

```
DEFINE "TRIANGLE [its name]
```

```
FORWARD 500
```

```
RIGHT 120
```

```
FORWARD 500
```

```
RIGHT 120
```

```
FORWARD 500
```

```
RIGHT 120
```

```
END
```

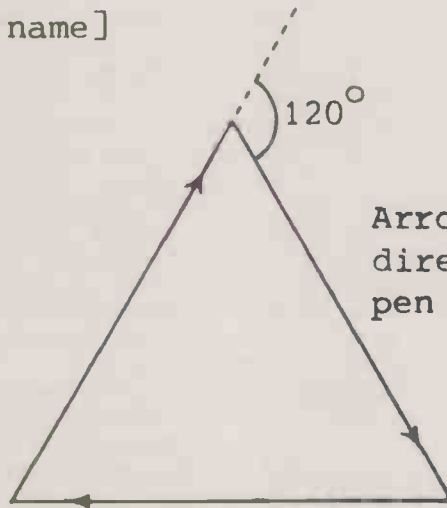

Arrows indicate
direction of
pen movement

Given a simple graphics program, the computer becomes a mechanism for drawing geometrical shapes — in this case a triangle.

close guidance which a novice needs on being introduced to new skills, new concepts and new ideas. Yet it does allow him to experiment and to be creative.

We can contrast the simplicity of the novice's model with the complexity of the expert's model by comparing the two figures on the previous page both of which depict a Lifting Shovel.

The program as a modelling toy

Can we create modelling systems for other non-engineering domains which will provide similar opportunities to experiment and to be creative? Perhaps the most versatile modelling system is the digital computer. Using the computer as a modelling tool is similar to using a kit of components as a modelling tool because the computing activity centres on using a programming language to describe how some structure or mechanism is made.

The designers of the Meccano system had to decide what components should be provided, and how they would be combined to form meaningful structures and mechanisms. The designer of a computer-based modelling system has to face up to exactly the same problem. He has to decide which instructions should be included in the modelling language, and how they would be combined to form models.

What we are referring to here is designing an appropriate representational system for a particular class of task, eg composing tunes, generating poetry, making drawings. In practice, this is a

very difficult problem, and one which is shared by research workers in Artificial Intelligence who are trying to create and experiment with computer-based models of complex cognitive processes like seeing the objects in this room, making sense of the words I am using and understanding the issues I am raising.

Once such a system has been designed, it can be implemented on a general purpose computing machine, converting that machine into a domain specific representational system. This involves writing the domain-specific modelling language which is used to describe the structures and mechanisms, ie processes, in that domain.

Notice that instead of starting from scratch, the modelling language can be written in one of the existing high-level structured programming languages, such as Pop-2 (Burstall *et al*, 1971); Logo (Feurzeig *et al*, 1977) or Smalltalk (Ingalls, 1978). This saves time and eases the process of altering or extending the modelling language in response to modelling needs, but suffers from the disadvantage that the modelling language inherits the host language's weaknesses and limitations.

Since this explanation is quite difficult to grasp, let me illustrate it with a simple example of a representational system for drawing pictures. Suppose the modelling language provides commands which can control the movement of a mechanised pen around a drawing surface, for example FORWARD a distance BACK a rotation, RIGHT a rotation. These commands can be used to make a pro-

gram which describes the process of drawing some object, for example an equilateral triangle.

When the description of the process of drawing a triangle is typed in, the computer becomes a mechanism for drawing a triangle. Operating the mechanism, ie running the program, produces the drawing of the triangle. Notice that the program can be stored in the computer's memory, and can be re-used by calling it by name.

Suppose the child wants to draw a house: all he needs to do is break down the house into two components, namely square and triangle. Having worked out how to draw a square in terms of basic pen movements, and having defined and stored the corresponding program, he can define a new object called house which is described in terms of a call to the object named square and a call to the object named triangle.

Defining descriptions

Notice that by defining and storing descriptions, the representational power of the drawing system is being made more readily available. This is like building up standard sub-units from Meccano parts, eg a gearbox, which is used subsequently in a variety of different vehicle types. In fact, instead of expecting children to assemble everything from the basic components, modern Meccano systems contain sub-units like cabs for lorries.

In similar fashion, a drawing system might contain instructions which would invoke pre-defined programs for drawing

and the next illustrates $\frac{2}{3}$ divided by $\frac{1}{4}$,

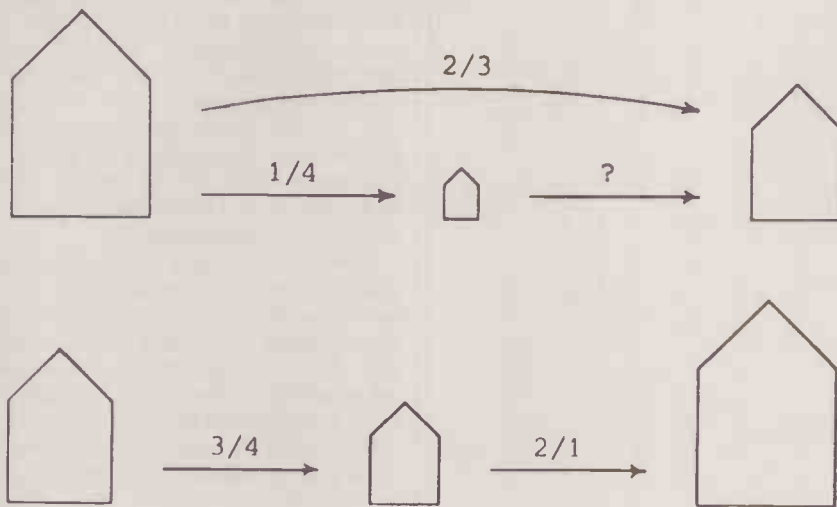

A triangle and square together make a house: different sized houses illustrate mathematical fraction operators.

unit forms such as the house described above, and that drawing system might become a sub-part of another representational system. For example, du Boulay (1978) uses the change in size of a simple house outline as an iconic representation of fraction operations in mathematics. The picture above illustrates fractional operators.

Acting out the role of the pen

The drawing system described earlier was devised by Papert (1972) to enable children to learn about geometry. Since it is a relative geometry, couched in terms of changes in the heading of the pen, it is easy to use it to describe regular figures. Movements of the pen correspond roughly to a child's own movements through space, so he can try to "act out" the role of the pen to help him work out how to construct a particular shape, or how to correct a drawing that has gone wrong.

Just as using Meccano creatively involves a long period of apprenticeship, the same applies to learning to use the drawing system creatively to find out about geometry. For example,

1. He has to become completely familiar with the basic maths concepts, eg straight line, arc of circle, angle as rotation.
2. He has to learn how to assemble components to form descriptions, eg build procedures; use inputs, counters, conditionals.

3. He has to learn how to plan drawings, eg breaking down a complex drawing into a set of more familiar sub-parts which can be separately constructed but which are subject to mutual constraints when brought together.
4. He has to learn to cope with mismatches between the planned behaviour and the actual behaviour of the program, making modifications to solve problems. This is known as "debugging activity".

To these activities which are primarily concerned with learning the characteristics of the drawing system, and learning to use it to build descriptions of geometrical forms, can be added a third activity, namely using the programs as structured apparatus which can be explored by a pupil in a consistent way to yield new insights concerning the domain being represented.

For example, in the geometry application a child will write a series of programs to describe a range of different shapes. After a while, he is likely to notice that some of the descriptions are quite similar. This finding is likely to prompt him to construct a generalized program which can produce a class of shapes, and to understand the relationships between families of apparently different shapes by experimenting with the generalised program.

Having learned how to write a program to draw an equilateral triangle, he is introduced to the notion of a subprogram and the use of the REPEAT instruction. This makes him aware of the repetition of side and angle, ie

This article is taken from Expert Systems in the Microelectronic Age, edited by D. Michie and published by the Edinburgh University Press in December 1979, price £8.

FORWARD and LEFT, in his original program, and he defines a new program called TRIBIT which when executed draws one side and changes the heading. Now an equilateral triangle is drawn by a new program which runs TRIBIT three times. It is easy to generalize, and construct programs to draw squares and hexagons.

Drawing regular figures

In due course, when introduced to the notion of an input, greater generality can be achieved since the child can define now a program for drawing a range of regular figures. Called POLYGON, it uses a general sub-program called POLYBIT, which is run the number of times specified by the value assigned to POLYGON's input. The value of POLYBIT's input is determined by dividing 360° by the number of sides bounding the shape, eg POLYGON 3 specifies a triangle, POLYGON 4 a square, and so on.

Of course, it would be difficult to use a relative geometry to construct irregular plane shapes. For this, quite a different kind of representational system would be required, namely a system based on the use of co-ordinates and vectors. Working with these would impose quite different demands on a child's understanding of mathematical concepts, and would extend it in very different ways. Besides geometry, representational systems have been developed for a variety of school maths topics (du Boulay, 1978; Howe *et al*, 1979); composing tunes (Bamberger, 1972); orbital mechanics (diSessa, 1975); simple electrical circuits (Boming, 1979).

Relevance to education

In the introduction, we suggested that the child enjoyed the activity of model building more than playing with the final product. This accords with Papert's view

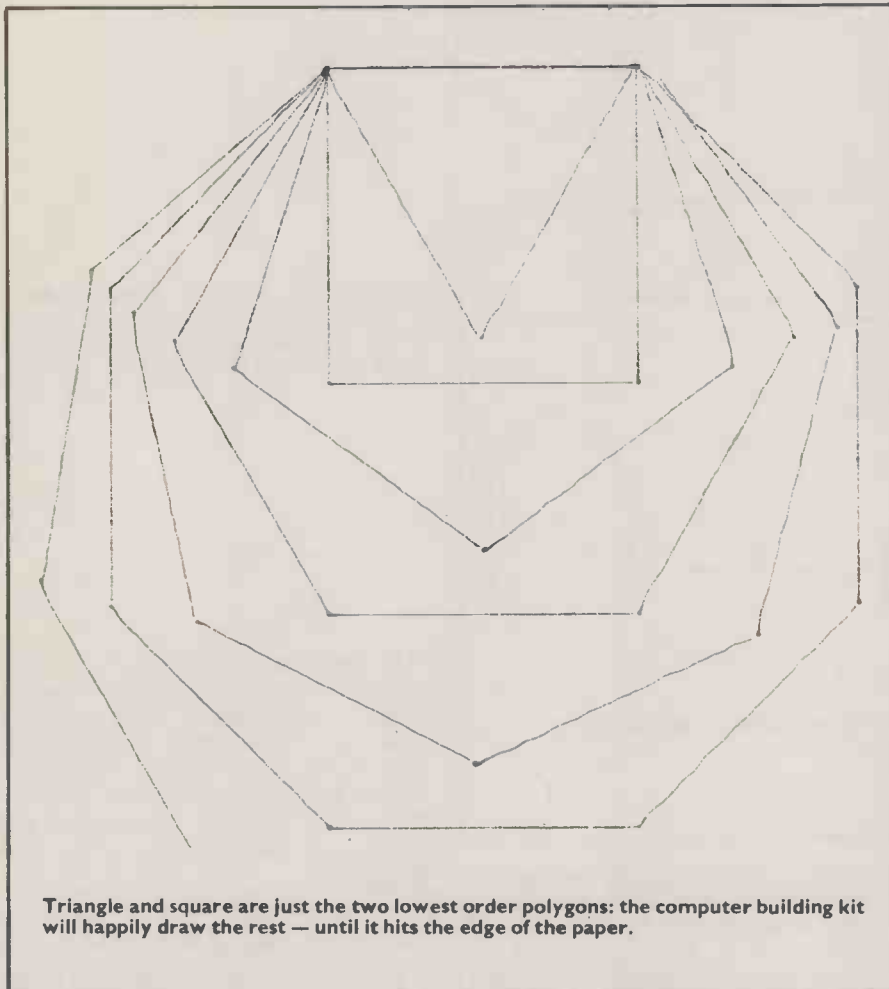

Triangle and square are just the two lowest order polygons: the computer building kit will happily draw the rest — until it hits the edge of the paper.

(Papert, 1972) that the programming approach should emphasize problem-solving skills in the expectation that when a child has worked in several different domains, he will recognize the similarities between the methods used to make plans and to debug them.

In this way, he will build up genuinely domain-independent study skills. While not wishing to deny the importance of such skills, others would take the view that these skills can only be appreciated when a person has extensive domain-specific knowledge, suggesting that in the early stages of learning emphasis should be placed on content learning.

Specimen procedure

The point is that the preferred emphasis affects the choice of objective with consequent effects on the way teaching is organized. For example, a highly structured approach has to be adopted if the objective is to teach domain-specific knowledge. In common with Goldberg and Kay (1977), the structure which we favour involves getting a child to learn by providing him with a model in program form which he types in and runs. This is followed by exercises which involve modifying the specimen procedure in minor ways, and finally adapting it to some other problem area.

This approach is followed whether the objective is to teach computational ideas as an aid to building programs (du Boulay and O'Shea, 1976) or to teach mathematics (Howe *et al*, 1979). In contrast to this emphasis on content, other investigators such as Papert (1972) and Dwyer and Critchfield (1978) focus on teaching problem-solving skills. New ideas are learned as and when necessary in the course of solving a selection of problems drawn from different domains.

Given these differences in emphasis, what evidence is there that children learn by building models in program form? It must be admitted that at present the evidence of benefit is scanty, irrespective of whether we are talking about content or problem-solving skills.

Dealing with the first of these, in one of the earliest studies Feurzeig *et al* (1969) taught arithmetic and algebra to 13-year-old children, using the Logo programming language. But the participants' scores on a standardised ability test were no better than those of a control group.

In contrast, Milner (1973) reported that Logo programming increased children's scores on an unstandardised test of variables, and Bjork *et al* (1975) describe how programming in Basic improve numerical ability, especially among the

less able children. Howe and O'Shea (1978) report marked gains in the mathematical self-confidence of 11-year-old boys participating in a mathematics course based on Logo programming, and more recently Howe *et al* (1979) report that both these boys' understanding of mathematics as measured by a standardised test and their ability to do school mathematics, as measured by a series of unstandardised school maths tests, improved relative to the performances of a more able control group.

Finally, in a case study of trainee teachers who investigated topics in primary school mathematics through Logo programming, du Boulay (1978) suggests that not only did they begin to understand the meaning of many basic mathematical rules, but they also found that they could make enjoyable personal mathematical discoveries by exploring the mathematical representations which du Boulay provided.

Problem solving skills

Turning now to problem-solving skills, there is less evidence of benefit. Statz (1973) records little improvement in children's ability to cope with problem-solving tasks after a year's programming activity. This problem of estimating improvement in problem-solving skill through programming is reminiscent of the problem faced by psychologists like E. L. Thorndike who tried unsuccessfully to collect evidence to support the strongly held belief that learning Latin helps a child to learn to reason. Like learning Latin, the belief that learning to program involves problem-solving must remain an act of faith until evidence appears.

But in the meantime, it would be wrong to conclude that the shortage of evidence supporting the programming approach indicates that it lacks educational value. After all, most educational schemes rest on the teachers' faith in their usefulness, and not on the results of a formal educational evaluation. Indeed, one might be tempted to question the need to produce such evidence to support the programming approach when everyday teaching procedures lack such substantiation.

Classroom context

Perhaps the most telling criticism is that most of the evidence available has been gathered in studies by committed investigators. The need now is to try out the modelling approach in educational institutions under the control of the institution's teachers, in conjunction with a continuing teaching programme. Survival under these circumstances is probably the best testimonial of educational worth. Given increased access to computers, we can expect relevant evidence to emerge from studies of the modelling approach in a classroom context during the next decade. □

MICRO
COMPUTERS
FROM
COMART
COME LIKE
THIS!

comart

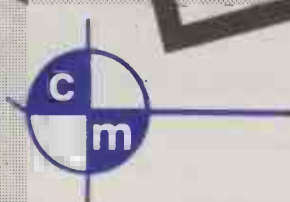

comart

SPECIALISTS IN
MICROCOMPUTERS

URGENT

SPECIALISTS IN
MICROCOMPUTERS

comart

We care about what leaves
our factory. After all it's got
our name on it.

The next time you want
reliable microcomputer
products - single card
computers, floppy disk
systems and disk systems -
take a look at what we put in
our boxes.

A Comart Computer Catalogue will
show you.

Write to



comart

Comart Ltd., P.O. Box 2, St. Neots,
Huntingdon, Cambs.
Or telephone (0480) 215005.

What rough beast, its hour come round at last . . .

. . . slouches towards the centre to be born? With an electronic memory, who needs a ball of twine and a female accomplice? Don't be amazed, there's no bull in our introduction to robotics.

by Mark Witkowski

Practical Computing and *Euro-micro* invite you to step into the 1980s and design your own robot — sixty years after Karel Capek coined the word. It's a challenge the talented do-it-yourselfer can't refuse. This background article is the first in a series on the science of robotics.

TWO 'MICROMOUSE' — type contests that were so successful in the States are included in the four sections of the *Euro-micro* — *PC* contest to be held in the autumn of this year.

These will be run under the rules and regulations laid down by the American Institute of Electrical and Electronic Engineers (IEEE) magazine *Spectrum*. A robot 'micromouse' has to be designed and built to run a maze constructed to strict specifications. These rules and specifications are available from *PC*.

In addition to a section in which the micromouse must run the maze in the shortest time, a second section is open to mice that can explore and learn the maze and then use this information to find the optimal path through the maze from the start in one corner to the finish in the maze centre.

This has much to commend it as competitions go; the rules are well defined and the construction of a mouse is well within the resources of most individuals and small groups. Bear in mind that *Spectrum* has been running this type of competition for some years now, so there are already many tried and tested mouse designs.

Allen (78) gives details of just three of the entrants in the 1977-79 trials. These three, the 'Moonlight Special', 'Microbot' and 'Charlotte' recorded times through the maze as low as 51.4 seconds, though several minutes was a more typical time. Each had a microprocessor on board, two had Z80's and one an Intel 8748. Later in the series, we will look

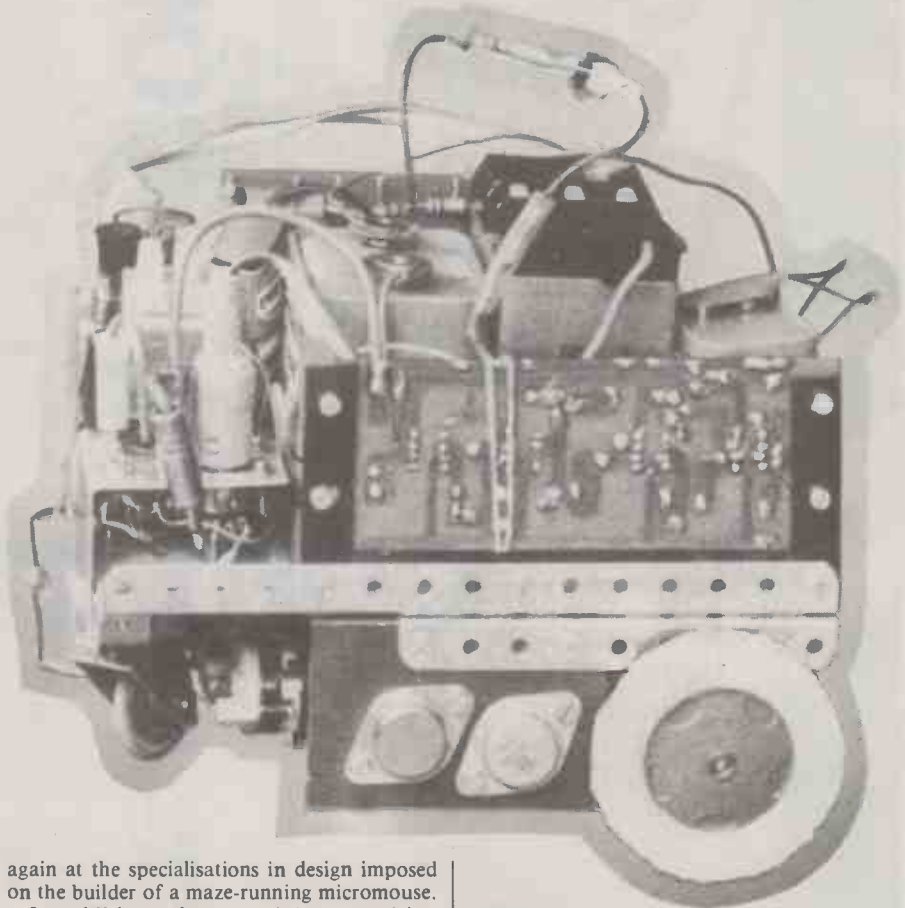

again at the specialisations in design imposed on the builder of a maze-running micromouse.

In addition, the new *PC* competition includes a section for 'free-style' robots, and this is a golden opportunity for the robot enthusiast to show some real ingenuity in the choice of robot, its design and design implementation. This first article discusses the various types of robot that have already been built and are in use. From these you should be able to choose some aspect of robotics that takes your fancy.

As you will see, there is plenty going on in one way or another. The rules of the competition are sufficiently flexible to accept equally innovation in the form of a totally new idea or improvements to existing ones. Future articles will be dedicated to a summary of the multiple skills that are needed, with practical hints on how to go about building robots, although we do not intend to provide a 'constructional' design.

To complete a robot project using a microprocessor will involve some mechanical construction, some electronics to interface processor to wheels and monitor any sensors; programming to write the control software; a certain quantity of luck; and not a little

perseverance. In terms of the flexibility offered to small 'hobby' robots, microprocessors hold out a considerable improvement over machines that are wholly hardwired.

The most famous of these hardwired automatons must be Grey Walter's *Machina speculatrix* (Walter 53), which showed some interesting, if limited, light-seeking behaviour. Since then, most hobby electronics magazines have produced their own design or designs (eg Brown 69, Brown 71 and Galitz 72, who produced machines called EMMA, ZEE! and Cyclops). The behaviour of such a machine (shown in photograph one) was based on that of the planarian, and its control strategy closely modelled on biological principles.

The dictionary definition of robot is that of a mechanical man, or an automaton with some human-like quality. The word is usually thought to have entered the English language after a play by Karel Capek called *R.U.R.* (*Rossums Universal Robots*) which was trans-

continued on next page

continued from previous page

lated from Czech in the early Twenties. In Czech the word 'robota' means statute labour or servitude, and is therefore well applied to machines manufactured in human form to do manual labour. As with most fiction concerning robots it is something of a cautionary tale. Interestingly most of the friction between people and robots in fiction results from robots being sufficiently intelligent to be a nuisance. In fact, any current conflict appears to stem from exactly the opposite cause — very stupid robots doing exactly as they are told.

By far the most successful application of robots to date has been their use in industry. For the numbers used, hours of work completed and usefulness, they are far ahead of any other form of robot usage. They are not, of course, suitable for every aspect of manufacturing, but they are currently used in many industrial processes for moving partly-completed objects between stages, die-casting, materials handling and palletisation, machine-tool loading, welding and paint-spraying. Photographs two to seven show a small selection of the many makes and types on the market.

Pick-and-place

Photograph two shows a Unimate 4000-Series pick-and-place industrial arm. It has a maximum reach of nearly three metres, with about 1.3 metres variable, a horizontal sweep of 200 degrees and a vertical sweep of 50 degrees, with a lifting capability of up to 175kg. Typical robot payloads vary from 10 to 100 kilograms (from data sheets given in Rooks 72 and also Abraham, Stewart and Shum 1977). The hand of the Unimate is interchangeable for a wide variety of tasks — the photograph shows a sheet-metal lifter.

Photograph three shows a Hall Automation robot with a torch attachment. Photograph four shows a general view of the DeVilbiss-Trallfa paint-spraying robot. The control unit for this robot, photograph five, shows the tape units used to store the sequence of spraying actions ready for playback.

A key (leftmost unit on the control panel, second row down) can either be set to 'Teach' or 'Repeat'. In 'teach' mode, a handle is attached to the end of the arm and the machine is led through the desired sequence of movements by a skilled operator. When the work-piece is satisfactorily sprayed, the handle is removed, the switch turned to 'repeat' and the machine will reproduce the sequence, either as a 'one-shot' continuously or under the command of a switch or photocell that indicates when a new work piece is aligned, ready in front of the robot.

Photograph six shows a pneumatic arm, interesting mainly for its fluid logic controller (photograph seven) — quite a way removed from microprocessor control!

An electric beam arm manufactured by the British United Shoe Manufacturing Co can be raised, lowered and rotated on its vertical pillar as well as moved in and out. The wrist at the end of the arm can be rotated, and the gripper rotated in two dimensions.

Point to Point (PTP) operation differs from that used in spraying or welding robots. These use continuous path — all intermediate points are recorded. A typical control unit would offer in the region of 1024 points or 500 inches of continuous-path operation.

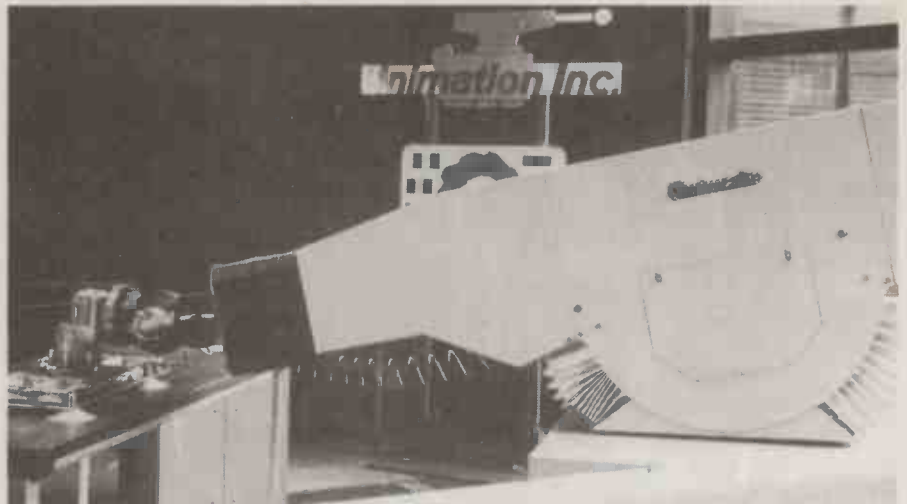

Figure 2: Unimate 4000-Series pick-and-place arm.

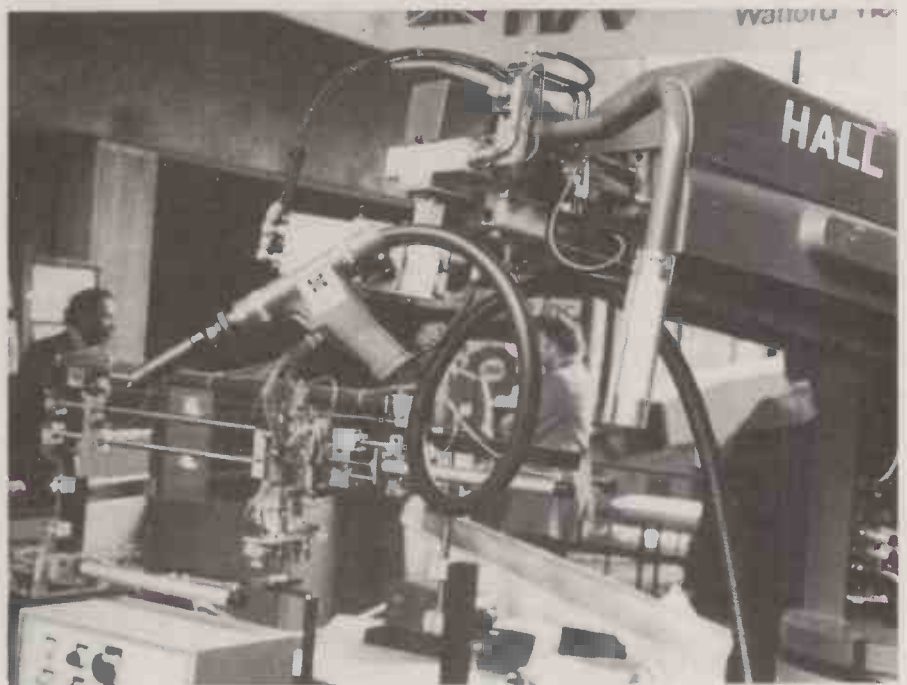

Figure 3: Hall Automation robot with torch attachment.

There are many reasons why robots may be desirable in industry. They find obvious applicability in those industries that are dangerous, or unpleasant for people to work in. Undersea, nuclear power-plants and mining all fall into this category. A robot also remains oblivious to tasks where heavy or hot loads are to be transported, to high levels of noise, or where noxious fumes are present. Robots are ideal where the work to be done is of a highly repetitive nature, requiring no skill from a person, and as a result are undesirable jobs.

Industrial robots are sold as a cost-effective method of introducing a higher degree of automation into processes where the production run is not high enough to warrant the full expense of total 'hard' automation. Robot manufacturers will stress the cost savings over either people or specialist machines (Engleburger 79).

Grounds for the introduction of an industrial robot on the factory floor might include lower initial cost than 'hard' automation and lower running costs — than either people or other types of machines. Reliability is good and work-rate predictable. Unim-

ation quote an up-time of "better than 98%". It is versatile too, and can be reprogrammed for other tasks where hard automation would have to be scrapped when the run is finished.

Zermio, Molesley and Braun (79) give a more comprehensive list of robot applications, and review various surveys that have been completed as to why manufacturers actually introduced robots in the specific application of spraying and coating. They also estimate that there are about 8000 robots in industry worldwide, 3000 of them in Japan, 2500 in the USA and 2000 in Europe. Of the European robot-using countries, Sweden and West Germany have about 600 each, although estimates vary considerably, and Italy about 400.

The United Kingdom would only seem to have about 70 such machines and is the only country to show a reduction in the number since 1975. Interest in robotics, however, remains high in the UK and in the year September 1979 to November 1980, seven out of 19 international conferences and exhibitions listed in the *Industrial Robot* journal are in England.

As yet, sensing and feedback play only a

continued on next page

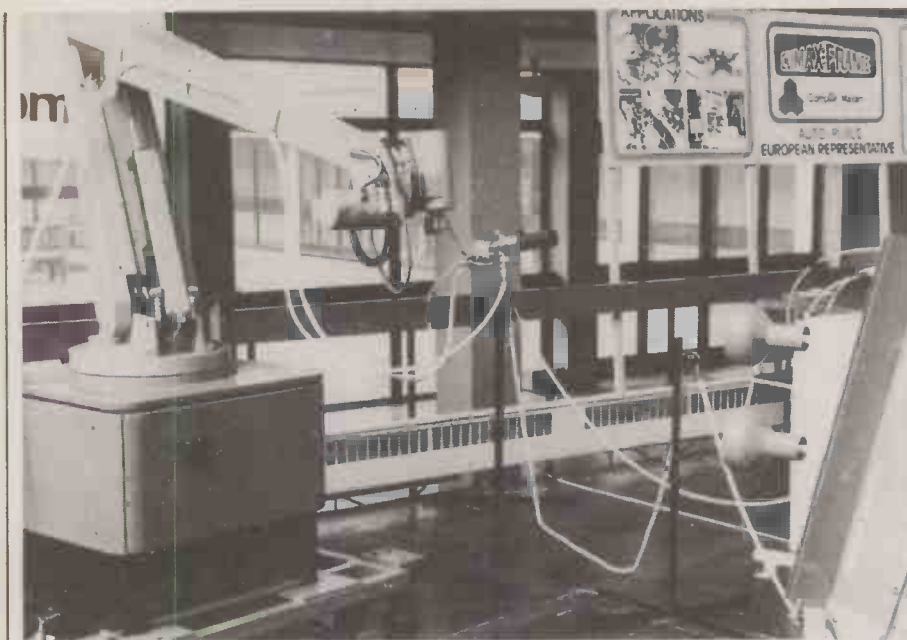

Figure 4: DeVillbiss-Trallfa paint-spraying robot.

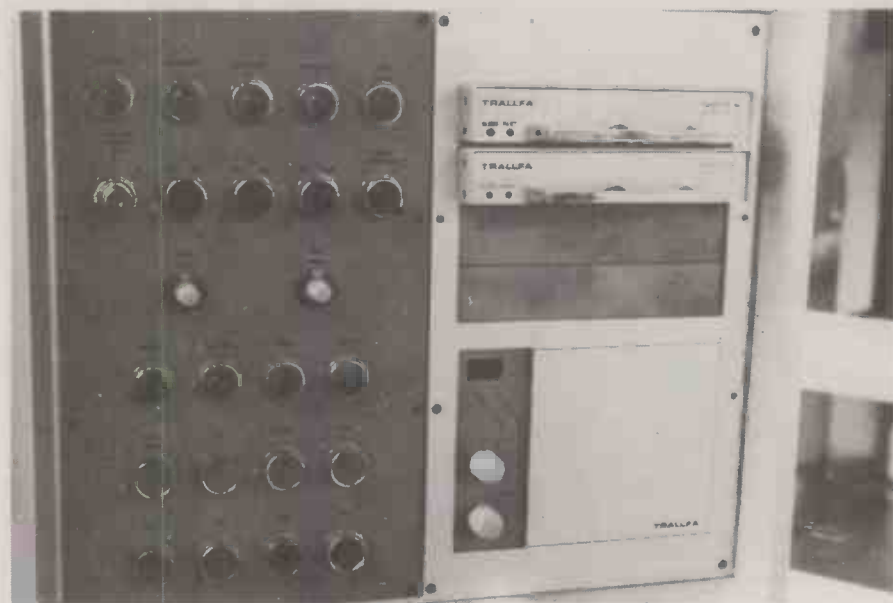

Figure 5: Control unit for paint-sprayer.

minor part in industrial robotics; they may be used either to guide the robot more effectively in situations where the work-piece is presented unpredictably, and increase the safety margins, both for people who work in close proximity to robots and other machines. These sensors tend to be rather fragile and in harsh industrial setting would soon be damaged.

It is also remarkably difficult to design sensors that really do detect all the things they should. Furthermore, the amount of computer power required to interpret this information rises sharply, and programmers with these specialist skills are rare. Wang and Will (78), of IBM describe some work on sensor development that might be generally applicable. Perkins (78), at General Motors, has been looking at the more specific problem of recognising parts used in the manufacture of cars with digitised TV pictures.

Robot 'brains' are now very much the province of the computer scientists, more specifically that of artificial intelligence research. Those of you who are following the current series on artificial intelligence in

Practical Computing will notice that there is little danger of the 'super-intelligent' machine appearing any too soon to give us all a hard time. This is quite distinct from super-powerful machines being controlled by intelligent men.

There is a growing number of artificial intelligence researchers who feel one of the main limitations to progress in their field is that the only contact the program has with the outside world that it must be intelligent about, and the people it must communicate with, is through a teletype device.

While it is no doubt theoretically possible to input every scrap of knowledge the program must have, in this way it does show a number of major limitations. Apart from being incredibly hard work, it also deprives the machine of many potent sources of information, firstly the ability to process raw data, like that which pours in through our eyes, ears, nose, mouth and skin, and secondly the program's inability to make important correlations between different information received through different senses about the same event.

It is the lack of muscles and limbs that really

restricts. These can be used to check the validity of the program's observations, deductions and assumptions. However complete a logical proof appears, the result is still rubbish if any of the axioms upon which it is based is false, or even inapplicable within the context of that proof.

Robots provide the eyes, ears, skin (and any one of a hundred different other senses modern instrumentation techniques can provide), as well as the muscles to move and behave that a complete artificial intelligence program will need. We would have no hesitation in saying that an example of natural intelligence would be at a severe disadvantage without these abilities.

There are still relatively few robots involved in artificial intelligence research. Some researchers will not use them on principle, others feel they do not need them; linguists, for instance, have enough problems without becoming involved with all the electronics and mechanics required.

Pre-processed data

Some programs require their data in a highly preprocessed form and in any case would not work fast enough to handle the data rates the real world produces. Even simple sensory systems such as touch and range-finders must be scanned so often if transitory effects are not to be missed that the complete power of a mini-computer can easily be used up just processing this.

When it comes to vision input from TV camera, the problem becomes horrendous.

Consider that a 100×100 retina matrix, scanned 10 times a second, which is less than 3% of the resolution of an ordinary television, would only allow two or three machine instructions per picture point on an ordinary mini-computer. It may actually take several hundred instructions per point to analyse the picture properly.

Two projects that used both robots and television input to computers were the Stanford Shakey project, which has been described as the first complete robot system (there is a brief description of the project in Jackson 74). Freddy at Edinburgh University is the second (Barrow & Crawford 72, Ambler et al 75 and Michie 79).

Shakey was a free-ranging robot with a camera that existed in a suite of rooms. Its control was provided by a suite of programs, a specialised vision program, a theorem prover that planned its actions according to pre-set goals, and a low-level controller to convert the plans produced into real actions.

Freddy was a hand-eye system, a manipulator and TV camera that could be used to construct toy models from their parts. Freddy had an interesting construction.

Shakey and Freddy

The gripper was suspended from the roof and could grip, turn and move up and down. A particular object would be selected by moving the floor in an X or Y direction. Both of these projects suffered due to a reversal in government funding policy towards artificial intelligence and robotics in the early Seventies.

One mobile robot we have examined has seen a good deal of service in artificial intelligence research over the past few years. It is hardly as grand as Shakey or Freddy, mainly because it has never been funded properly — even though it has been used by a number of funded projects.

continued on next page

continued from previous page

In one sense this has been an advantage because it was protected from the more abrupt changes of heart by funding agencies. Unfortunately the quality of engineering required for this type of work was not up to scratch for lack of cash.

Over the years, facilities have been added as and when possible, and all the initial problems are pretty well solved. The vehicle has no 'intelligence' of its own. It is just a motorised base with integral power supply (batteries) and a multi-way analogue-to-digital converter. Into these A/D channels are plugged a range of standard sensors, with plenty of spare capacity to add new ones required by any particular project.

Every single action it makes is under the control of one or more computers. Communication is via the thin wire visible in the photograph. In the five years since the project was started it has been interfaced to a wide range of micro, mini and main-frame computers. Programming languages ranging from 6800 assembler to POP-2, through Fortran, C, RTL/2 and Algol-68 have all been used — depending on the preferences and experience of each of the users. This set-up is sufficiently versatile to allow a wide range of robotic experiments to be carried out. These have included such topics as (at undergraduate, post-graduate and research levels) map-building and best-path generation, navigation using only on-board sensors and external coordinate generating devices in separate experiments. Tracking and limited pattern recognition using the 32 by 32 binary camera have been investigated.

Mainstream research

Long-term research has been based on biological modelling, learning by production rule and more generalised learning and problem solving techniques, this latter project forming a complete robotic system. Apart from this, considerable effort has gone into the construction of the human interface end of the business. This includes the design of programming languages, computer systems and inter-computer communication.

Most recently, the mainstream of our research has taken a path more closely aligned with the requirements of man-robot co-operation, with man, robot and computer working as a team to solve problems: robots with their superior strength, accuracy and special adaptations to the task, the computer to analyse data from specialised transducers and for fine control, also to prepare sensory data for presentation to the human in its most helpful form. The man is there to supervise, guide and be prepared for the unexpected.

The current machine is not designed for this and we are busy designing and constructing a vehicle which is a motorised base, with two multi-axis arms and a TV system capable of digitising a 256 by 198 point picture in one-fifth of a second. Computer power is provided by three 64K LSI 11s.

From the amateur point of view, there are many robot designs that could form the basis of a home-brew machine. For the maze contest, the restrictions to the design are quite severe; it must perform a fixed task in a well-defined arena. For a more free-style robot, the first decision to be taken is about the form of the robot.

Close attention must be paid to the mechanical design of an industrial-arm type of robot, but these have been attempted in the home. Most have five or six degrees of freedom and

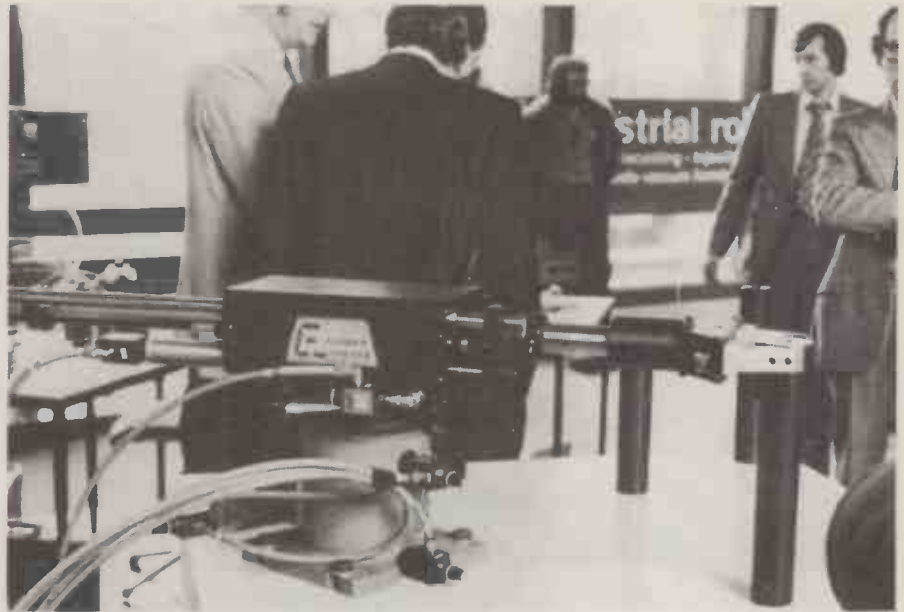

Figure 6: Pneumatic arm ...

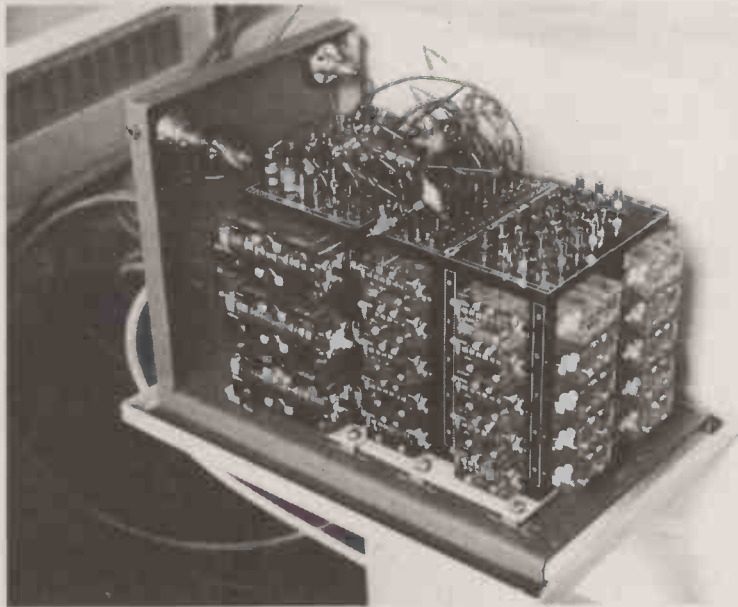

Figure 7: ... and its fluid logic controller

there are two popular configurations. Some follow the DeVillbis-Tralifa paint sprayer, and model the human arm, with shoulder, elbow and wrist, but if you do not have access to a full machine-shop in which to build it, a type which features some combination of cartesian joints that slide the polar ones that swivel (eg the British United Shoe Manufacturing Co) may be more appropriate.

Electric motors are a useful compromise between power output, availability, controllability and ease of interfacing to a processor. Stepping motors provide adequate accuracy for open-loop control, though if they are used at shoulder and elbow joints, the weight of the remainder of the arm and hand may require rather larger and hence more expensive motors.

Be careful that the design eventually chosen can both reach all the places you want and that the larger joints have a comfortable margin of strength and power. The arm must not only be able to lift its own weight, but also that of some payload.

For good power-to-weight ratios and high speeds of operation, hydraulics and

pneumatics are an excellent choice, and they are much in evidence in industrial units. They do tend to be expensive — particularly proportional valves and pumps. They can also be very powerful, so a solid design is called for if the slightest software fault is not to pull the whole thing apart.

In an 'industrial'-style competition entry, solid, well-engineered designs start with an advantage. Nothing is more disconcerting than a shower of 6 b.a. nuts and bolts each time the thing moves. Real credit, however, will surely go to the design that incorporates ingenious and appropriate sensing, but is also easy to use on the shop floor; when it comes down to brass tacks, good engineering only takes money — good ideas are precious.

You would be up with the leaders if the arm could pick an item in a random orientation off a conveyor belt and leave it in a specified place and orientation. If the arm picked the object out of a hopper full of them, it would be ahead; if it can do it at about the same speed as a person, patent it — quickly. Judges will

continued on next page



Figure 8: British United Shoe electric beam arm

continued from previous page

probably look for a design which is versatile, quick to adapt to a new task, and requires minimal modifications to the gripper between jobs.

Many people and organisations have proposed robots to help in the home. Every so often the news is full of a robot to be "programmable for a range of household tasks", available "soon" (always "soon"), for "a few thousand pounds". Such announcements are invariably met with a quite uncharitable degree of cynicism from those researching into robotics; still, one day, 'soon'!

The task is not impossible, just damn difficult; one could try to design a vacuuming machine. It might just go down better with the loved one than a robot that spills hot hydraulic fluid over the carpet. Criteria for a good hoovering robot would include its hoovering everywhere, right to the edges, moving the furniture, sometimes, not knocking the Ming vase off its stand or running over the cat sleeping in the most inconvenient place possible.

Androids and golems

Robots have been used in education too. A good example is the Logo project from the Massachusetts Institute of Technology (MIT) (Papert 71). These small computer-controlled Turtles have been used to teach a range of concepts to young children in computing, mathematics and music. The children can use the Logo programming language to control and then program the robot to give them insights into processes of computing and computers.

These techniques are used successfully to hold the interest of the children in traditionally unpopular or difficult subjects. Competition entrants who are teachers or interested in education could well try something along these lines. Quite a lot of work has already been done, so better read around a bit.

Assorted automatons, androids, golems, robots and bionic entities are frequently featured in stories, films, plays and pictures and there is no reason why these should not form a

valid part of any robot scheme. Jasia Reichardt's recent book *Robots: Fact, Fiction & Prediction* (Reichardt 78) treats robotics mainly from the artist's point of view.

An example of robots making art, as opposed to being in art, is provided by Harold Cohen's work. He uses a turtle, with pen attached to its underside to draw child-like pictures under the control of a PDP 11/40. These pictures may cover over one hundred square feet. The program consists of about 300 interconnected rules about the artwork it is to produce (Lansdown 78).

Robots and medical prosthetics, artificial limbs, are closely linked (Todd 78), and the full mechanisation of wheelchairs would almost certainly depend on robotic principles. Many of the artificial intelligence applications of robots in the past involved very large investments in computer power. Shakey, for instance, used a PDP 15 for local control, connected to a specially paged PDP10. Freddie used a local Honeywell H316 and an ICL 4130, ours uses a local PDP11/10 connected to an ICL 1904S.

The much considered and computed deliberations and then actions of any of these machines could not be described as rapid or real-time. This is partly because of the languages used to implement the high-level ('intelligent') end of the system. They tend to be relatively slow interpreted languages, used not for their efficiency, but for the power they provide the programmer. It is possible that by careful recoding of these ideas, probably with some reduction in complexity, considerable improvements in performance could be obtained.

The amateur is well situated to take the best ideas of artificial intelligence and modify them into a useable form. A program that could translate instructions in English to the correct robot actions, or one that could plan a course of robot actions using knowledge about the environment, giving reasons for each choice, or a robot that modified its behaviour according to sensory information in a sensible fashion, should all be welcome entries. More than this, they would all be worthwhile work in their own right. □

References

- Abraham R.G., Stewart R.J.S. and Shum L.Y. (1977): *State-of-the-art in adaptable-programmable assembly systems*. England: International Fluidics Services Ltd.
- Allen R. (1978) *Three amazing micromice: hitherto undisclosed details*, pp 62-65. IEEE Spectrum (November 1978).
- Ambler A.P., Barrow H.G., Brown C.M., Burstall R.M. and Popplestone R.J. (1975): *A versatile system for computer-controlled assembly*, in *Artificial Intelligence* 6-2 (Summer 1975), pp129-156, North Holland Publishing Co.
- Barrow H.G. and Crawford G.F. (1972): *The Mark 1.5 Edinburgh Robot Facility*, in *Machine Intelligence*, 7, Meltzer & Michie eds. pp 465-480.
- Brown G.C. (1969): *EMMA* in: *Practical Electronics* 5-3 (March) p 196, 5-4 (April) p 275.
- Brown G.C. (1971): *XEE!* in *Practical Electronics* 7-6 (June) p 484, 7-7 (July) p 568.
- Engleburger J.F. (1979): *Robotics in 1984* in *The Industrial Robot* 6-3 (September 79) pp 115-119.
- Galitz L.C. (1972): *Cyclops*, in *The Radio Constructor* 25-12 (July) p 736, also 26 1,2,3,4,5.
- Jackson P.C. (1974): *Introduction to Artificial Intelligence*, New York; Petroselli/Charter, pp 386-389.
- Lansdown J. (1978): *Not only computing — also art*, in *Computer Bulletin* 2-15, (March 78) pp 14-15.
- Michie D. (1979): *Preserving the vital link of comprehension* in: *Practical Computing* 2-9 (September 1979) pp 60-65.
- Papert S. (1971): *A computer laboratory for elementary schools*, A.I. Memo 246, Cambridge, Mass: MIT Artificial Intelligence Lab. Also: Various authors — Logo memos.
- Perkins W.A. (1978): *A model-based vision system for industrial parts*, in *IEEE Transactions on computers*, Vol C27-2, (Feb 78), pp 126-143.
- Reichardt J. (1978): *Robots: Fact, Fiction & Prediction*, London: Thames and Hudson.
- Rooks B. (1972) (ed.): *Industrial Robots — A Survey*. England: International Fluidics Services Ltd.
- Todd D.J. (1978): *A Computer-Controlled Manipulator*, in *Computabits* 4 pp 2-11.
- Walter W.G. (1953): *The Living Brain*, London: Gerald Duckworth & Co (1957 edition).
- Wang S.S.M. and Will P.M. (1978): *Sensors for computer-controlled mechanical assembly*, in *The Industrial Robot* 5-1, (March 78) pp 9-18.
- Zermeno R., Moseley R. and Braun E. (1979): *The Industrial of Robots*, in *The Industrial Robot* 6-3 (September 1979) pp 141-147.

DATA LINK

Microcomputer Systems Limited

Systems software for business, industrial and scientific applications

MICROSTAR 45 PLUS



A multi-user disk based information processing system designed for commercial application where extreme simplicity of operation is required.

MicroStar Double Density
2.4Mb £5650
Additional 20 Mb Hard
Disk Unit £4950
Available Software

includes Mailing List, Word Processor,
Purchase Ledger, Sales
Ledger, Payroll, Invoicing, Etc., Etc.,

APPLE/ITT 2020

Specifically designed to handle the day-to-day activities of education, business, financial planning, scientific calculation, and brings to the user a new level of simplicity through design sophistication.



Apple II Plus 16K (B&W) £750 ITT 2020 16K (colour) £867
Disk Drive with Controller £398
Parallel Printer Interface Card £110
High Speed Serial Interface
Card £110 Centronics Card £132
Communications Card £132
Pascal Language System £296
Auto Start ROM Pak £40
16K Add-ons £69
Alf Music Synthesiser
Card £215

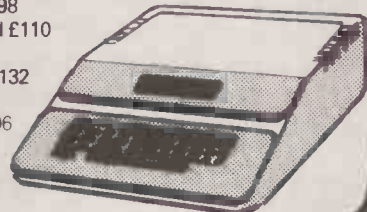

VDUs/Terminals

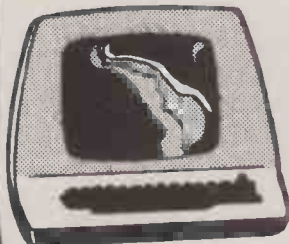

Lear Siegler ADM 31 £849
Lear Siegler ADM 3A £620
Hitachi 9" VDU (B&W) £127
Hitachi 12" VDU (B&W) £187
ITT 340 16" Colour TV £220

Printers

Centronics 779
Tractor feed £875
Printerm 879 90 col.
£695
Printerm 879 80/132
col. £745
Microhush £266
TTY 43 Pin or Friction feed £860
Paper Tiger £585 Qume Sprint 5 £2115

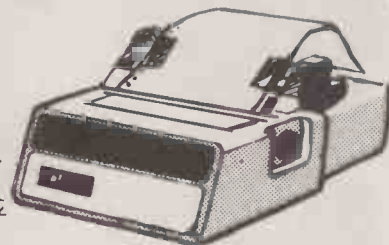

Systems Furniture

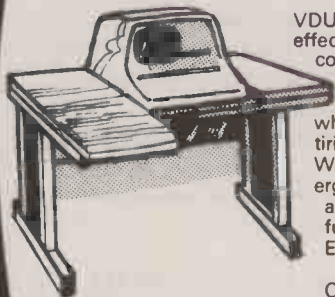

VDUs are increasingly an essential and effective form of business communication. Their impact and efficiency can be impaired by incorrect mounting and siting which results in uncomfortable, tiring, eye-straining operation. We have available a wide range of ergonomically designed VDU Desks and Terminal Work Station furniture.

Example: Apple VDU Desk £144.10
Printer Table £91.30

Orders can also be taken for custom designed furniture.

Computer Stationery and Accessories

9 1/2" Plain Listing Paper (per 2000 sheets) £16
Microhush Thermal Paper (2 rolls) £4
Customised Computer Stationery (Invoices/Statements/etc) P.O.A.
Mini-Diskettes From £2.50
Diskette Library Cases £3
Diskette Tray with Lockable
Lid £16
Mini-Diskette Head Cleaners £13
Dust Covers £9
Sound Boxes for PET,
mains or battery (own
manufacture) T.B.A.

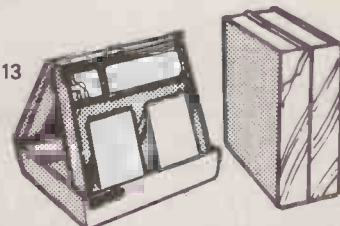

We also stock an extremely comprehensive range of computer books

DATA LINK

10 Waring House, Redcliffe Hill, Bristol BS16TB
Telephone: Bristol (0272) 213427

The Perfect Lead...

Acorn Microcomputer System 1



Price £65 plus VAT in kit form

This compact stand-alone microcomputer is based on standard Eurocard modules, and employs the highly popular 6502 MPU (as used in APPLE, PET, KIM, etc). Throughout, the design philosophy has been to provide full expandability, versatility and economy.

Specification

The Acorn consists of two single Eurocards.

1. MPU card
6502 microprocessor
512 x 8 ACORN monitor
1 K x 8 RAM
16-way I/O with 128 bytes of RAM
1 MHz crystal
5 V regulator, sockets for 2K EPROM and second RAM I/O chip.
 2. Keyboard card
25 click-keys (16 hex, 9 control)
8 digit, 7 segment display
CUTS standard crystal controlled tape interface circuitry.
- Keyboard instructions:
Memory Inspect/Change (remembers last address used)
Stepping up through memory
Stepping down through memory

- Set or clear break point
- Restore from break
- Load from tape
- Store on tape
- Go (recalls last address used)
- Reset
- Monitor features
- System program
- Set of sub-routines for use in programming
- Powerful de-bugging facility displays all internal registers
- Tape load and store routines

Applications

- As a self teaching tool for beginners to computing.
- As a low cost 6502 development system for industry.
- As a basis for a powerful microcomputer in its expanded form.
- As a control system for electronics engineers.
- As a data acquisition system for laboratories.

START WITH SYSTEM 1 AND CONTINUE AS AND WHEN YOU LIKE

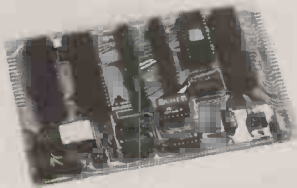

Acorn Controller
£35 plus VAT (min config.)

the CPU card of System 1, it allows for up to 4½ k EPROM, 1¼ k RAM and 32 I/O lines. It has on board 5 V regulator and optional crystal control. Custom programs may be developed on System 1 and the card makes an ideal dedicated hardware module.



Acorn Memory 8 k
£95 plus VAT (kit form)

A fully buffered memory card allowing up to 8 k RAM plus 8 k EPROM on one eurocard, in an Acorn system both BASIC and DOS may be contained in this module. Static RAM (2114) is used and the card may be wired into other systems.

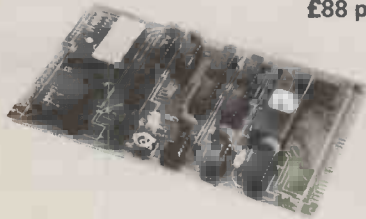

Acorn VDU
£88 plus VAT (kit form)

A memory mapped seven colour VDU interface with adjustable screen format. Full upper and lower ascii and teletext graphics are features of this module which along with programmable cursor, light pen, hardware scroll etc., make this the most advanced interface in its class.

Acorn Software
in ROM

- Acorn BASIC — a very fast integer BASIC in 4 k
- Acorn COS — a sophisticated cassette operating system with load and save and keyboard and VDU routines in 2 k
- Acorn DOS — a comprehensive disc operating system in 4 k

Acorn Computers Ltd.
4A Market Hill, Cambridge, Cambs.
Cambridge (0223) 312772.

Order Form

Please send me the following:

- (qty) Acorn Microcomputer kit @ £65 plus £9.75 VAT.
- (qty) Acorn Memory kit @ £95 plus £14.25 VAT.
- (qty) Acorn VDU kit @ £88 plus £13.20 VAT.
- (qty) Acorn Power Supply (for System 1 only) @ £5.95 plus £0.89 VAT.
- (qty) Acorn Microcomputer assembled and tested @ £79 plus £11.85 VAT.
- (qty) Acorn VDU assembled and tested @ £98 plus £14.70 VAT.

Post and packing free on all orders.

I enclose a cheque for £
(indicate total amount) made out to Acorn Computers Ltd.
Please send me further details of this and other Acorn options

Name _____

Address _____



Acorn Computers Ltd. 4A Market Hill, Cambridge, Cambs. (0223) 312772. Regd. No. 1403810

• Circle No. 197

Head up your own letters

Rex L. Tingey finds out what Commodore's Printer can do

AT LAST Securicor delivered the Commodore Printer. Now I could discover all that it would do — and all that it could not. The model had become the 3022 Tractor printer instead of the cheaper 2023 (now 3023) Matrix printer since the 3022 was the only model immediately available after a wait of six months. At least the "Letter Writer" programme, compiled in readiness for the arrival, worked, and it was soon coupled with a letter-heading programme once the graphical possibilities of the printer had been explored.

Line writing

The programme is virtually in two parts. The first part is a line-writing programme, up to Line 9, with a self-contained destruct device which cancels the part completely when it is no longer required. The lines written at this time are numbered to follow the next part of the programme, so that the text of the letter follows the heading.

The second part of the programme constructs and prints a personalised letter-head, to be printed on all copies of the letter, and filed on tape each time with a letter.

The line writer first requests input of the date, so that it may be printed on the letter, and then presents seven numbered and stated print lines, with correct tabulation. After the letter lines have been written on the 60 or so spaces of each of the seven, a further Return puts up seven more lines numbered to follow.

At the end of the letter, the cursor can be shifted down to the lowest screen printing and a Return given. This puts onto the screen a line of numbers at the left edge, with the cursor over the top one; by Returning down these numbers, the line-writing programme is cancelled. A RUN prints the letter, together with its heading, on the printer.

The heading

The line-writing part is adaptable to various Basics, but the heading will require some variations for machines other than Commodore printers. This is because this printer has its own unique commands, instructions and addresses, together with the enhanced character capability plus the forming of a new character constructed from the matrix dots. It is possible to construct a new character for every printed line.

PET C TITLER
 100 COMPUTER LANE, PROGRAMMING STREET TEL: 0101

12TH JANUARY 1980

Dear Sir,

With reference to your computer programme 'Letter Writer', note that the lines can be readily justified, and that the date is inserted as input, but in a permanent way, so that it is recorded, should the letter be filed on tape.

The line-producing part of the programme is cancelled after the letter is complete, so that only the heading and text are left for storing. The heading remains part of each letter.

Spaces between the lines and paragraphs can be varied by the PRINT#4 and PRINT#6 variations.

Errors are very easily corrected.

Yours sincerely

The example letter and letter-head

The programme opens up files, accesses the printer, and directs information to the correct secondary addresses. It prints the letterhead, and, after printing the letter, closes the files to avoid errors in further work on the computer.

The heading employs the enhanced character capability of the printer, which spreads the characters to two, three or four times their normal width. It employs the high resolution reversed field, which needs a new ribbon for a first-class black. Graphic lines are included above and below the reversed line to improve readability.

The programme

The programme is written entirely in Pet Basic but some of the control characters are different when using the printer. Some of the CHR\$ numbers normally giving a blank are used, and others normally giving a symbol do not respond in the way expected. A major difference is that all letters are typed upper case on the screen and controlled by Cursor Up and Cursor Down keys: the Cursor Down following a Quote produces lower case on the printer.

The first line of the programme starts a device for taking string data, normally held only in the memory, and transferring

it over to the second part as a programme line, preventing it being cleared by RUN. This is achieved by an Input to Z\$ — the date — which then reappears above the first batch of letter lines, contained in a "Print" line — 155 — with the cursor flashing on the line for fixing with a Return. The inverted commas — only one set is necessary — are achieved by inserting the Quote character code before Z\$.

The line numbers are consecutive, but this can be readily altered by changing the "A" figures to A + 10, for example, and to A - 20 etcetera, with a starting value on line 1 of A = 180. The programme puts up seven lines at a time, which should be sufficient for a good paragraph.

The screen will take nine lines, and this can be obtained by altering line 5 to IF B = 11 GOTO . . . Line 6 is nearly full length, so that a blank line follows each numbered line, eliminating the need to Insert. Tabulating guides could be inserted on the blank part as an aid.

At the bottom of the screen, the cursor first alights on A = A - 2: GOTO 4, printed from line 7; when this is RETURNED on, the next set of lines appear. Below this is GOTO 2, and if the previous line is skipped with a Cursor Down, and this is RETURNED on, then lines 2 and 3 come up with a homed cursor, brought down onto

L & J COMPUTERS

3 CRUNDALE AVENUE, KINGSBURY NW9 9PJ 01-204 7525
THE "PET" SPECIALISTS

HARDWARE



COMPARE OUR PRICES!

PET 8K £499
 PET 16K £599
 PET 32K £725
 EXTENSION CASSETTE DECKS (WITH COUNTER) £55

DUAL DRIVE DISK UNITS

PET 3040 £740
 COMPUTHINK 400K £830
 COMPUTHINK 800K £998

PRINTERS

PET 3022 £640
 CENTRONIC 779 (Tractor feed) £869
 SWT PR 40 (Inc Interface) £295
 (becomes an on-line printer)
 TELETYPE 43 £875

SUNDRIES

TOOL KITS from £55
 VARIOUS INTERFACES from £40
 FLOPPY DISCS from £2
 PAPER: ROLL & TRACTOR FEED
 FULL RANGE OF PETSOFT & COMMODORE SOFTWARE
 If you can't see what you want — ask.
 We pride ourselves on getting what the Customer wants — quickly!

PRICES DO NOT INCLUDE VAT

SYSTEMS



WE OFFER SMALL BUSINESS SYSTEMS FOR UNDER £2600 WHICH CAN NOT ONLY CARRY OUT MOST OF THE DAY TO DAY CHORES, BUT ALSO HAVE ROOM TO SPARE TO COPE WITH THOSE "ODD JOBS". TAKE YOUR CHOICE!

EACH PACKAGE COMPRISES A 'PET' 32K, CABLES, ANY INTERFACES REQUIRED, BUT DOES NOT INCLUDE PAPER, DISKS ETC.

DUAL DRIVE DISK UNIT	TRACTOR FEED PRINTER		
	PET 2022	TELETYPE43	CENTRONIC779
PET 3040	£2099	£2399	£2399
COMPUTHINK 200K x 2	£2129	£2429	£2379
200K x 4	£2289	£2589	£2539

PRICES DO NOT INCLUDE VAT

SOFTWARE

As well as a full range of Petsoft and Commodore Software, we have some highly reliable "Home-Brewed" programs available.

STOCK CONTROL & INVOICING £60
 (Handles up to 500 items — 32K) (180 on 16K). Stock depleted on invoicing, search etc. Cassette, disk (& print option).

STOCK CONTROL & INVOICE (RANDOM ACCESS) £120
 On-line handling of 3400 items (50 char.) per disk. Disk (+ printer option) (16 or 32K) search etc.

ADDRESS/PHONE BOOK £35
 Create, amend, enlarge, search (+ print option) (16K or 32K).

MINI CAB/DELIVERY INVOICE & DRIVERS WAGES £220
 Weekly or monthly invoices — cheque writing facility — optional deductions. (16 or 32K + disk + printer).

INFORMATION RETRIEVAL £130
 Multi field; multi item; infinitely variable. Print facility: automatic sort.

ALARM CLOCK £5
 See the time — hear when you're overdue! (All Pets).

YOUR MONTHLY PLANNER £7
 Print your own planner on your own printer! Any year or month.

RANDOM ENTRY & ANALYSIS £40
 Makes adding up all those different invoices child's play! Cash, cheques etc., balances & VAT.

SCHEDULE 'D' £25
 Check your own tax without being an accountant!

SEND SAE. FOR FREE BROCHURE
PRICES DO NOT INCLUDE VAT.
 We can write specialist programs for you. Ask us for a quotation.

BASIC COURSE

IN RESPONSE TO MANY REQUESTS AFTER OUR VERY SUCCESSFUL ONE-DAY PROGRAMMING COURSE, WE ARE RUNNING ANOTHER ON THE 5th FEBRUARY 1980 AT THE SAME VENUE (EUROCREST HOTEL, WEMBLEY). COST (including Hotel Lunch, etc & VAT) £46.

EARLY APPLICATION IS ADVISED IF YOU WANT A PLACE. S.A.E. FOR PROGRAMME & APP. FORM.

ACQUISITION

You are welcome to try, browse & purchase at our premises. You can phone your order. You can fill in & send off the form below. Whichever way you choose, you cannot help but be delighted with our service.

ORDER FORM

TO L & J COMPUTERS:
 PLEASE SEND ME BY RETURN: —

_____ £ _____
 _____ £ _____
 _____ £ _____

ADD £9 for large items **
 ADD 50p for small items

VAT £ _____
 TOTAL £ _____

CHEQUE/P.O ENCLOSED*
 CHARGE TO MY ACCESS/BARCLAY/VISA CARD No.*
 (*delete as req'd)

ALL GOODS SENT SAME DAY WHEREVER POSSIBLE
 Recorded delivery by post: or Securicor.**



• Circle No. 198

the first number by Break and Ready signs.

The instruction "Cancel by Return" heads the screen, and a quick nine presses of Return cancels the line-making programme. Run and Return and the letter will print out on the printer.

Line 8, by the way, puts up a reverse field instruction above the date-line, but only on the first set of produced lines. The GOTO 10000 instruction on Lines 7 and 8 avoids the "Break in 9" as well as avoiding the "File not open" errors. The sending to a high address REM just produces a screen "Ready" and avoids the loss of screen space with "Break".

The letter-head programme half has the various secondary addresses and logical file numbers to enable the printer to perform. Open 5,4,5, for example, readies the printer memory for the binary-constructed special characters, formed using the data on line 101 as two characters A\$ and B\$, used to make the two-line T in the main heading. The CHR\$(254) prints out the character after the \$ has been printed to the 5 file.

CHR\$(1) is the enhancing instruction which doubles the character width, and increases within the line as many times as is required, but which is cancelled upon a carriage return: this makes some of the instructions limiting by taking up too much of the 80-character line-length.

Open 6,4,6;PRINT#6,CHR\$(no) establishes a line-feed length which remains until altered by a further instruction. The PRINT#4 instructions print one line of the specified feed-length. The comma tabulates in tens from left to right; there are now eight positions instead of the screen's four.

The files are closed within the

programme, at the end, and the computer will work as normal without the need to switch off the printer. If a programme is listed to the printer, it may be found that the Return key does not behave correctly, and that the cursor does strange things, even after a Close File has been completed.

Writing a letter

All upper-case letters are typed in for a line of a letter, and lower case is seen by the symbol Reversed Q, which is shift down, a shift back up is Reversed Ball. When justifying the lines, these symbols must be counted as extras in line length. In fact, the easiest way to justify is to write the letter with some line room left, and then to print out on the printer. On listing on the screen, the letter can be justified using the print-out as a guide.

The printer will print but stop before a line with an error, and display the usual "Syntax Error" and line number on the screen so that it can be corrected in the normal way after listing. The main error occurs whilst correcting lines where upper/lower case change requires "quote" on, and a correction requires "quote" off, leaving an odd "quote" in the middle of a line.

For invoices, receipts and accounts — AT LAST A POUND SIGN. Data to produce the sign is given here. The example is printed enhanced X2, but the short programme does not include this.

Now the bad news

One major reason for buying a printer, in my case, was for listing the programmes I produce for Petsoft, to give easy reference when checking or constructing the educational word programmes in upper

```

      3200
      240
      1805

10 OPEN5,4,5
20 DATA9,63,73,73,65,33
30 FORA=1TO6:READZ:Z#=Z#+CHR$(Z):NEXT
40 PRINT#5,Z#:OPEN4,4
50 PRINT#4,CHR$(254)" 3200
60 PRINT#4,CHR$(254)" 240
70 PRINT#4,CHR$(254)" 1805
80 CLOSE5:CLOSE4
READY.

```

Programme for printing pound sign

and lower case. However, lower-case from within a programme lists as the equivalent graphic symbol, which means learning a new language to interpret the symbols. To list a readable word-programme means that all the lower case has to be altered to upper, which is no check on the original programme, and very time-consuming.

Another defect is that, though it gives plenty of formatting options for data, the formatting for programme listing is minimal. By sending Alpha field information to the printer via a secondary address and logical file, it is possible to tabulate a listing to the right, but any line longer than the Alpha field is blanked at the end, and not printed; strings tabulated over have their surplus printed on the following line. What I required was a listing capability of 40 character-length lines, exactly as on the screen.

Apart from these criticisms, the printer performs well, producing good, clean copies. In its letter-writing function it gives a first-class heading, which could be used alone, the letter being typed on an ordinary typewriter. A small version of the letter-head could be used to produce personal and business cards, and other stationery — using your own name and address, of course, not the example given here! □

```

100 OPEN5,4,5:PRINT"Q
101 DATA126,0,96,1,127,127,127,96,1,126,0
110 FORI=1TO6:READA,B:A#=A#+CHR$(A):B#=B#+CHR$(B):NEXT:PRINT#5,A#:OPEN4,4
120 PRINT#4:PRINT#4,CHR$(1),CHR$(1)"  "CHR$(254)
130 OPEN6,4,6:PRINT#6,CHR$(18):PRINT#5,B#
140 PRINT#4,CHR$(1),CHR$(1)" I ET C "CHR$(254)"ITLER"
148 PRINT#4,,"
150 PRINT#4,," 100 COMPUTER LANE, PROGRAMMING STREET  TEL:0101
151 PRINT#4,,"
152 PRINT#6,CHR$(80)
155 PRINT#4,,"12TH JANUARY 1980
160 PRINT#6,CHR$(30):FORI=1TO4:PRINT#4:NEXT
201 PRINT#4,,"DEAR SIR,
202 PRINT#4,,"WITH REFERENCE TO YOUR COMPUTER PROGRAMME 'LETTER WRITER',
203 PRINT#4,,"NOTE THAT THE LINES CAN BE READILY JUSTIFIED, AND THAT THE
204 PRINT#4,,"DATE IS INSERTED AS INPUT, BUT IN A PERMANENT WAY, SO THAT
205 PRINT#4,,"IT IS RECORDED, SHOULD THE LETTER BE FILED ON TAPE.
206 PRINT#4
207 PRINT#4,,"THE LINE-PRODUCING PART OF THE PROGRAMME IS CANCELLED
208 PRINT#4,,"AFTER THE LETTER IS COMPLETE, SO THAT ONLY THE HEADING AND
209 PRINT#4,,"TEXT ARE LEFT FOR STORING. THE HEADING REMAINS PART OF EACH
210 PRINT#4,,"LETTER.":PRINT#4
211 PRINT#4,,"SPACES BETWEEN THE LINES AND PARAGRAPHS CAN BE VARIED BY
212 PRINT#4,,"THE PRINT#4 AND PRINT#6 VARIATIONS.
213 PRINT#4
214 PRINT#4,,"ERRORS ARE VERY EASILY CORRECTED.
215 PRINT#4:PRINT#4:PRINT#4:PRINT#4
216 PRINT#4,,"YOURS SINCERELY
9999 CLOSE6:CLOSE5:CLOSE4
10000 REM-AVOIDS'FILE NOT OPEN'ERROR

```

Program of the example letter, line-making cancelled

Travellin' to California

THE NCC SHOW, in Anaheim, USA, 19th-22nd May, 1980, is the computer show of the year. All the latest products and ideas will be on display.

To help readers planning a visit, Practical Computing will be offering a package to include the flight, hotel accommodation and tickets for the show. For further details of the cut-price deal, please contact us as soon as possible. There may have to be a limit on the numbers.

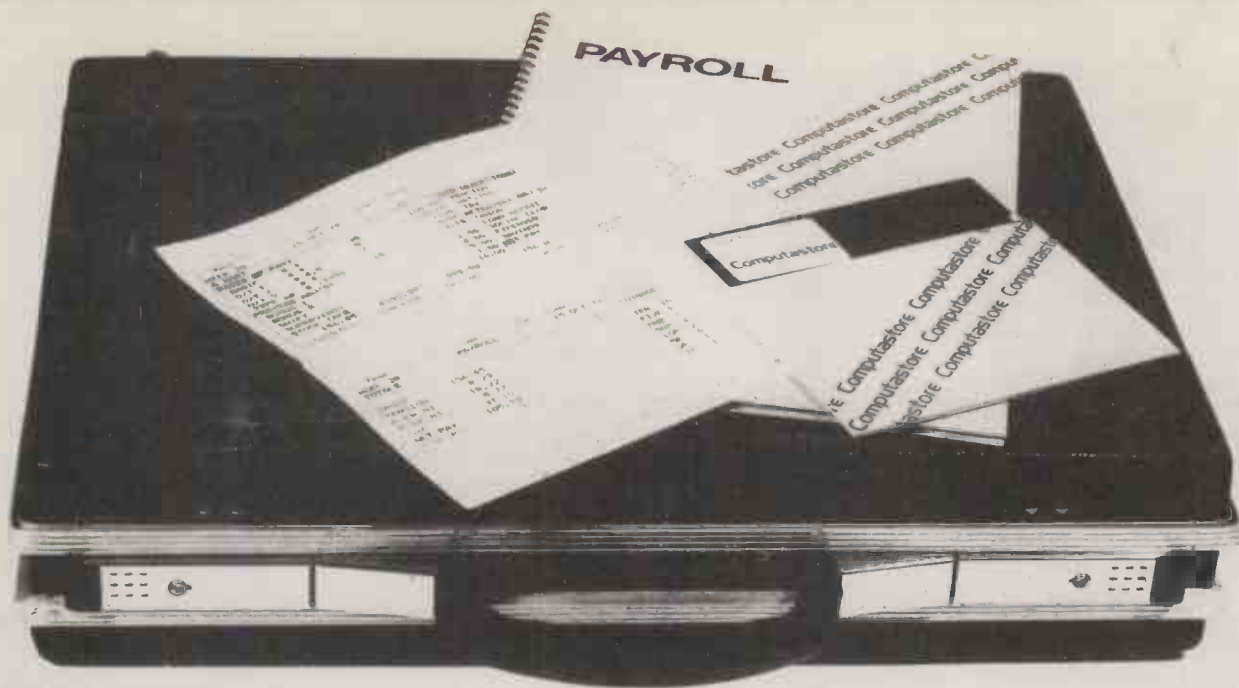

IN A CLASS OF IT'S OWN SUPERPAY FROM COMPUTASTORE

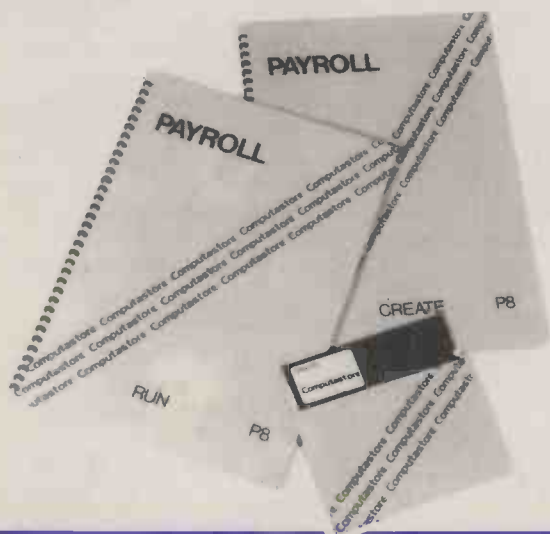

Professional standards and software support of the highest order are **guaranteed features** on all Computastore programs.

Other packages for the PET Series Microcomputers include:

PETE — turns PET into an intelligent RS232 terminal

ASSEMBLER — fast assembly up to 500 lines per minute

DISASSEMBLER — with powerful pattern search facility

KEYBOARD — permits program & data entry from remote keyboard

Unrivalled for speed and accuracy our new Superpay Payroll Program guarantees the PET user all the advantages of precise full payroll computing.

1. Unique Screen Layouts
2. Easily understood duplicate payslips
3. Payroll master file reporting and departmental analysis
4. Credit Transfer payments and coin analysis
5. Automatic Year-End analysis
6. Security and confidentiality
7. Reliable updating service for rate changes

The main features of Superpay are also incorporated into the Standard Disk and Cassette Options.

Computastore

Software that means business

Ask your local PET dealer or Computastore for a demonstration

**COMPUTASTORE Ltd., 16 John Dalton Street,
Manchester M2 6HG. Tel: 061-832 4761**

• Circle No. 199

RAIR BLACK BOX
MICROCOMPUTER

POWER

LOAD

RESET

RAIR MICROCOMPUTER
BLACK BOX

*Discover the secrets of
the RAIR Black Box*

109

"My best Apple programs are on long-term deposit in the City... it pays rather well!"

We brought the first five Apples into the U.K. in November '77, with every penny we had. In November '79, we find several thousand throughout the country.

THANK YOU Apple owners.

Now we'd like to help you re-coup your investment by cataloguing and supporting the best Apple programs in the U.K. The Apple Software Bank is more like an old penny bank than a major clearing bank, but we know you'll help it grow. Telephone Stephen Derrick on 01-626-8121 to discuss your investment.

ATTENTION ALL Estate Agents, Employment Agencies, Yacht Brokers, Antique Dealers and Motor Traders. Find out about **FINDER SOFTWARE!**

SOME BLUE CHIPS

TESKIM. This ROM will simulate the Tektronix 4010 family of graphics terminals. It's rather good!

UPPER LOWER CASE ADAPTOR A chip for the chap considering word processing.

NEW ISSUES

We are continually trying to bring the latest add-ons for your Apples. Please phone for the latest product information and data sheets.

NEW PRODUCTS

8" SHUGART DISKS giving 1.2 Megabytes A twin drive (with room for a third.) disk system with controller and software, give tremendous commercial possibilities. £2350 Excl. V.A.T.

WORD PROCESSOR. Ask about our Apple II Plus word processor package. Complete System with Diablo 1650 Daisy-Wheel Printer. £4250 Excl. V.A.T.

PERSONAL COMPUTER PRINTERS. Sensational 40 & 80 Character printer (graphics options) from £243 Excl. V.A.T. Interfaces for Apple, Pet & TRS 80. High quality silent printers. It's your choice!

A/D BOARD At last we have either an 8 bit or 12 bit A/D card for Apple. Excellent spec from £125 Excl. V.A.T.

APPLE PASCAL £296



Personal Computers Limited

194-200 Bishopsgate, London EC2M 4NR.

Let us advise you about **COLOUR DISPLAY** on your Apple. Contact Technical Services.



● Circle No. 203

Practical Computing Back Issues

If you are interested in microcomputers you will want to read the *Practical Computing* reviews of the machines in which you are interested. Each month *Practical Computing* carries at least one hands-on test of a popular microcomputer for use in business, the home, schools and colleges. Each review contains the kind of information you need - technical data and unbiased critical comment on the strengths and weaknesses of each system.

Each issue is packed with essential reading on microcomputers, including all our regular monthly features: Book and cassette reviews; Glossary of computer terminology; Computabits; Pet Corner (February onwards); Apple Pie (May onwards); Tandy Forum (March onwards); serialised *Illustrating Basic* (October 1978 onwards).

All this makes *Practical Computing* the invaluable source for the whys, wherefores, hows, ifs and buts of microcomputing.

November 1978

Review: Tandy TRS-80 Projects for KIM. Pet goes to school; VAT accounting complete program Part 2; Complete game program - Mastermind; Software Dynamics Basic compiler review.

February 1979

Reviews: Cromemco Z-2D. Low-cost peripherals; Systems for estate agents and doctors; A £1000 payroll system; IBM typewriter conversion Part 2; Complete game program - Warlock Warren.

December 1978

Review: Research Machines 380Z. Choosing your first computer; ITT interview; Complete games programs - Battleships, Racing Cars and Monsters; A microcomputers reservation system.

March 1979

Review: Single-board computers for less than £50. Low-cost stock-control systems; IBM typewriter conversion Part 3. New monthly column - Tandy Forum. Complete game program - NIM.

January 1979

Review: Nascom I. Convert an IBM typewriter into a terminal Part 1. In-car computing - Pet in the Panther Deville Report from the Los Angeles Computer Faire; Pascal v. Basic.

April 1979

Review: North Star Horizon Business accounting systems. Apole II design story Part 1; Computerised school meals; Finance for school computing; Build your own frequency meter, Star Trek game.



May 1979
Reviews: Exidy Sorcerer, Science of Cambridge Mk 14. Printers for less than £1000; Order processing/invoicing packages; Retire with your computer Apple II design story Part 2; Slalom game.

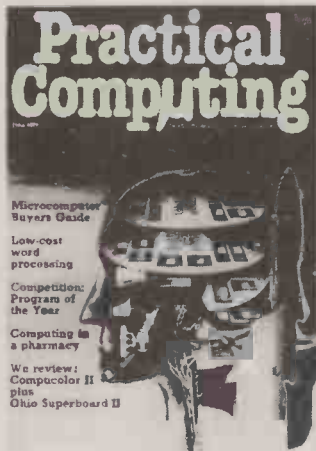

June 1979
Reviews: CompuColor II, Ohio Superboard II Low-cost word-processing; Computing in a pharmacy; Designing a small business application Part 1; Computer v. Brain; Zombie game.



July 1979
Reviews: AIM-65, SOL-20 Choosing your first computer; Interfacing Pet with a mainframe; Nascom story; Designing a small business application Part 2; Biorhythms program.



August 1979
Reviews: Pet II KIM, Pros and Cost of PASCAL Microcomputer user groups. Designing a small business application Part 3; Interfacing Pet with a mainframe Part 2; Life game program.

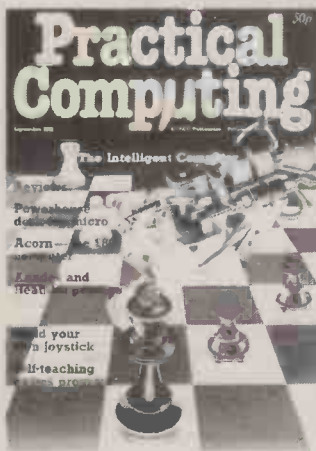

September 1979
Reviews: Powerhouse 2, Acord, Anadex and Heathkit printers Artificial intelligence; Build your own joystick; Computer scene in the North-West; Mathematics on a Pet; Self-teaching games program.



October 1979
Reviews: Disc systems for Pet, Apple II and Tandy; Build an electronic scoreboard; Inside Speak & Spell; Introduction to LISP; Inside Prestel.

November & December 1979 issues sold out



January 1980
Reviews: Hewlett Packard HP4/C, TEL systems Eurapple - Whats in store for 1980. Computer graphics. Using a micro to measure pain responses. Getting started with micros.

Only the above issues are still available. Fill in the coupon opposite and return it with your remittance to *Practical Computing*, General Sales Dept, Room CP34, Dorset House, Stamford Street, London SE1 9LU. Please note that back issues can be ordered only on the current order form opposite.

Gallery moves out of the flat earth era

THE REGENT GALLERY, in Cheltenham, is a typical small business. Founded sixteen years ago by one man, David Bannister, it has grown slowly but profitably and with the recent international boom in 16th and 17th century maps has carved itself a valuable niche in a skilled and competitive market.

But in the past couple of years David, and his recently acquired fellow director, Peter Baxter, have had to look for new ways to cope with the problems of growth.

"The main difficulty in map dealing," explained David Bannister, "is that whenever you sell a map you have to replace it. As you might imagine, there is only a limited supply of 16th and 17th century maps. Most people only buy maps as a form of investment or saving and will only resell when they are hard-pushed for cash.

"The result is that we have had to spend more and more of our time travelling around Europe and the States, seeking out dealers and private collections and trying to persuade them to sell, sometimes at the expense of keeping track of the enquiries at the Gallery. The business has grown so fast it has become extremely difficult to remember every item we have in stock."

David, who built the business on picture framing and decorative prints, suddenly found that his stock of maps was producing enquiries from all over the world.

"When someone writes in and asks for a list of every world map we have in stock, it could take the better part of a working day to check through every item and write a good reply, simply in the hope that he would like to buy one of the maps on the list. But the time came when we couldn't

by Duncan Scot

afford to reply to every enquiry. We were obviously losing a lot of potential business."

They both spent months talking about the problem when the suddenly both hit upon the idea of computerizing the list of maps. Neither of them knew anything about small computers, but Peter had once helped install an IBM system at an insurance company and had picked up enough knowledge to write a detailed specification.

A friend introduced them to Commodore Business Systems and they were persuaded to buy a PET. The software was supplied by Petsoft. "As far as we are concerned," said Peter Baxter,

the PET was not a serious computer. And the software was not up to what we wanted to do." The PET is now lying idle in a back room.

Armed with his specification, Peter wrote to a number of dealers inviting tenders, for what was, essentially, a stock-control and information-retrieval system for about 700 maps. The response was disappointing. Both David and Peter were horrified by the number of official dealers who appeared to know next to nothing about the systems they were trying to sell. David said "You just have to be firm. Any small business must be prepared to shop around and find the right system or go elsewhere."

Special program

They found their solution at the Byte Shop in Nottingham. "The manager recommended a system based on the North Star Horizon and put us in touch with a software specialist called John Potter, of Loveden Computer Services. He agreed to write a special program for a very reasonable sum."

The least impressive offer came from Keen Computers. "They offered to butcher one of their standard stock control packages for nearly five times as much as Potter wanted."

Maps can be classified in a number of different ways — for example by the cartographer or by region. "Most of the maps we deal with were drawn by one or other of sixteen cartographers," says Peter. "But then most of our buyers ask for listings by region."

Classification system

The menu program is simple. Maps can be listed by any one of 21 regional groupings, by cartographer or by regional grouping and cartographer. There are also, of course, options for amending or deleting entries.

Each of the sixteen major cartographers has his own entry; the rest fall into one part or another of an eight-part alphabetical listing.

Each one of the 700 maps in stock is classified by the region the map covers, the name of the cartographer, its status — whether it has been sold, in which case it will be removed from the system by the end of the day, and the map's value. Each entry also includes a title, a description and a four- or five-line narrative for the information of potential buyers.

There is no doubt that the system is useful. One letter which arrived when I was there asked for a listing of all the maps in stock of Scandinavia, the Polar

David Bannister and Peter Baxter in their studio, with a 17th Century world map and their North Star Horizon-based information retrieval system in the background.



Regions and Sussex. Such a list could be printed within minutes, leaving plenty of time to deal with other aspects of the business.

In writing the program John Potter, of Loveden, managed to alter the standard interpreter on the North Star Horizon and cut out all the functions which were unnecessary for this application, such as the trigonometry functions. This gave almost 2KBytes of extra main memory to play with.

He also fitted the 700 map entries onto a single 5in diskette by means of data compression techniques. John explained: "This particular application divides everything into very neat categories, with the same names appearing several times. In some cases we have been able to reduce the conventional storage sizes by factors of up to 20."

He has now adapted and developed the system, dubbed Mapox by Peter Baxter, but renamed LOCATE, into a range of packages for antique dealers and book-sellers who have to deal with similar problems.

Surprisingly — and this is rare — the Gallery did not experience any of the difficulties normally associated with bringing computers into small business operations, except for the first abortive attempt with the PET. The package was running within days of delivery and the files were complete within weeks. David is now planning to extend his use of computers into other areas of his business, starting with his mailing list.

Right: Peter Baxter with a map of Cheshire by John Speed, issued in 1627. John Speed is the best known English cartographer and his atlas *The Theatre of the Empire of Great Britain* was the first collection of separate maps of the English and Welsh counties.



Below: A typical printout from 'Mapox'.

REGENT GALLERY

14 Regent Street, Cheltenham
Gloucestershire, England
Tel. 0242-512826

Telex 27950 (Ref. 2088)

LIST OF SELECTED MAPS CURRENTLY HELD IN STOCK AT THE REGENT GALLERY,
PREPARED FOR MR. DUNCAN SCOTT, PRACTICAL COMPUTER.

REF.	REGION	CARTOG.	DESCRIPTION	COST (£)
LT 12	Middle East	Ptolemy	ARABIA ULM 1482 ORIG COLOUR	3750 CG
Arabian Peninsula from Ulm edition of Ptolemy's Geography. Magnificent original colouring. The Ulm Ptolemy was the first atlas printed in Germany and the first woodcut atlas in the World.				
A very rare map in excellent condition.				

Deletion list of

REF.	REGION	CARTOG.	DESCRIPTION	COST (£)
LT 12	Middle East	Ptolemy	ARABIA ULM 1482 ORIG COLOUR	3750 SD
Aborted				

The design of small, fast good programs is not an art of esoteric complexity. Keep it simple and code it late, urges C. A. Malcolm.

Smaller, faster, quicker, slicker...and more elegant too

MICROPROCESSORS and personal computers are new phenomena, but programming computers is a well-established craft. I have been inspired to write this article by the number of extraordinarily ponderous, lengthy and obscure programs I see published in the micro journals! It is not hard to write much better programs. It is not a black art of esoteric complexity, nor does it require great experience — on the contrary, it depends only on the careful pursuit of simplicity, a pursuit steered by a few general principles which practice has shown to be useful.

Many things distinguish the programs produced by a good professional programmer from those written by newcomers to programming. One of these is that his programs are smaller and run faster. In this article I shall show you the general principles for designing small fast programs. Not surprisingly, this strategy also tends to produce more elegant programs.

There does always come a point where elegance can be sacrificed for gains in smallness and speed. It is important to postpone this point as far as possible, so that you do have some elegance to sacrifice! In most cases, however, the pursuit of elegance and neatness of design produces sufficient gain in size and speed that it is not necessary to go to the final stage of optimising bodes.

It is often difficult to follow an abstract theoretical discourse, however correct and excellent, so I shall illustrate the general rules of programming for designing small fast programs by developing a particular example. I shall take an example which everyone will be familiar with, and which many of you will already have played with: finding the prime factors of a number. This strategy will enable you to write a factoring program for your machine, whether PET, NASCOM, programmable calculator or whatever, which will run between 2 to 'n' times faster than anything you have seen published in a magazine, where 'n' can be quite large! This is also the crucial kernel of a prime number program.

Refine the design

Note that I mention "design", rather than "writing", in the title.

The first important rule is to refine the original design, *not* the written code.

We shall begin with finding the prime factors of a number, simply and crudely

without any thought at all, just to give the design wheels something to grip. This starting point is illustrated in figure 1.

This is a very simple algorithm, and it works. There are obvious ways of making it go faster, and we shall proceed by examining these.

To begin with, it is not necessary to try divisions by divisors greater than the square root of the number being divided. For example, if trying to decide whether 101 is a prime, since $\sqrt{101} < 11$, dividing by 11, if it worked, would produce another factor less than 11 — and we would have found the other factor already, if it existed, in a previous division.

It is tempting, having recognised this, to stick in a simple test before each division, "is the divisor less than the square root?", and many programs do just this. But this involves calculating the square root afresh each time round the loop. If it takes 25 divisions to establish that a number is a prime, the square roots will be calculated 25 times, when obviously it only needs to be calculated once! In general, the square root only needs to be calculated each time the number being divided *changes*, which is only each time a factor is found.

This illustrates an important principle of loop design: only put into the loop what has to be repeated; keep all the processing which can be done outside the loop, outside it.

Having thus improved the end condition of our first simple sketch design, what other obvious flaws has it? It tries every possible whole number as a divisor, when it is pointless, after the first divisions by two, to bother dividing by even numbers.

In fact, to generalise, we are wasting time by dividing by *any* number which is not a prime number. Ideally, it would be nice to hold a table of all the prime numbers, and extract the divisors from it. This is impractical for two reasons.

Split loops

The first is the memory it will take up. The second is, where do we get the list from? If it is a small list, we can set it up by hand as presets; if large, a program can set it up. But however large it is, it will never be large enough, if we wish to avoid restrictions on the maximum size of number we can examine. Therefore, without deciding at this stage how big this list of primes should be, it is reasonable to decide to split our single factor loop into two loops: one which extracts prime divisors from a list; and a second loop, which carries on from there, inventing divisors. It is an obvious saving only to invent odd divisors. This algorithm is illustrated in figure 2.

Our design is now getting fairly sensible and efficient, and is at the level of most published routines. But we should not rest

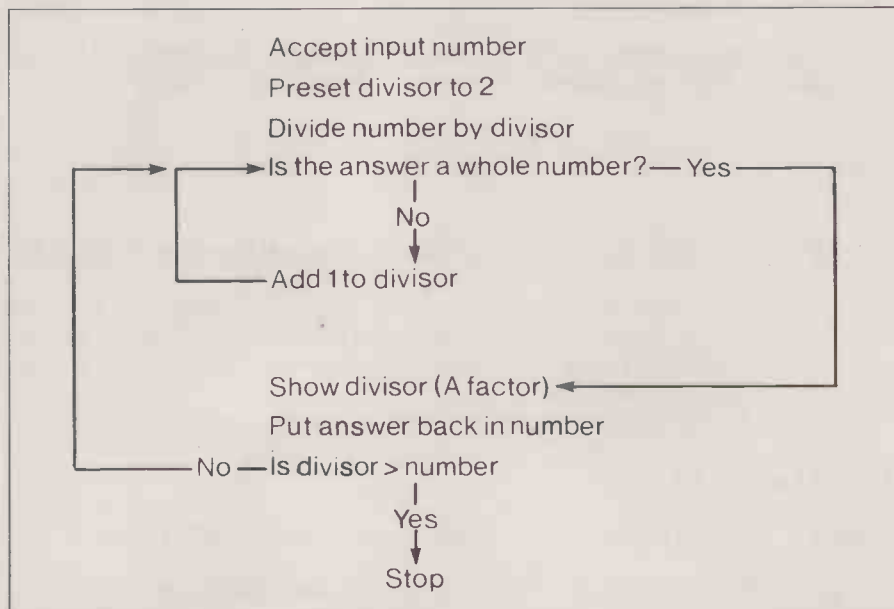

Figure 1: The simplest possible program

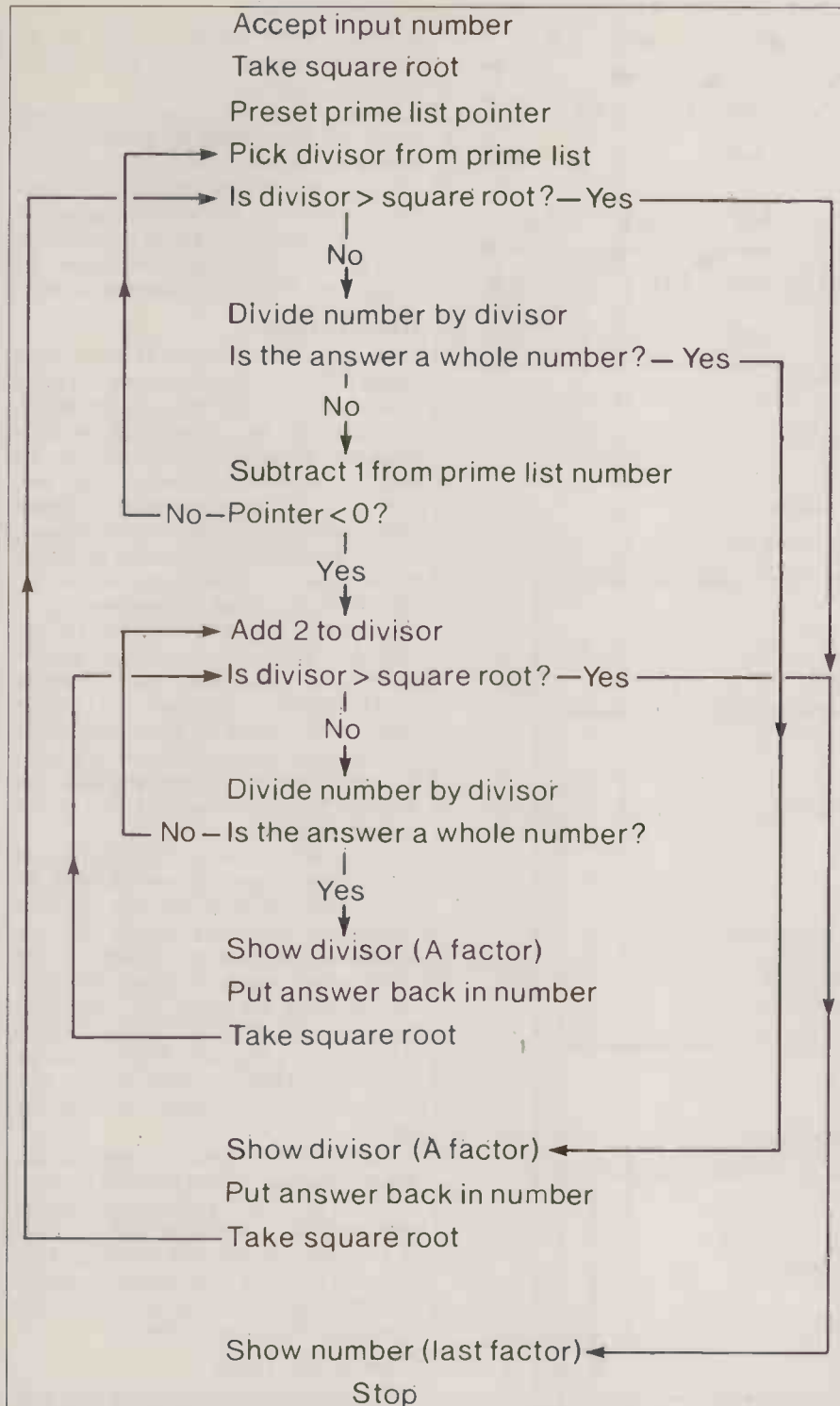

Figure 2: A reasonable first design

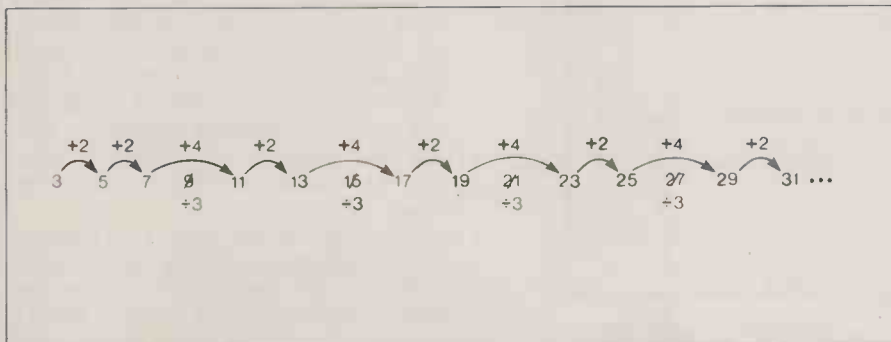

Figure 3: Omitting odd numbers divisible by 3

until we are clear that it cannot become substantially better. In fact, it will become a lot faster, and smaller!

Once outside the prime list, and inventing divisors, we are obviously wasting time still, by dividing by non-primes. We have improved the original design by omitting even numbers, ie, omitting divisors divisible by two. Is there a simple method of omitting divisors divisible by three?

Figure 3 gives a list of odd numbers, marking those divisible by three. It is plain that every third odd number is divisible by three, so that we can save 33% of our processing time by omitting them. It is also plain that if we invent divisors by alternately adding two and four to the last divisor, we omit divisors divisible by three. Since the omission saves 33%, the crucial question is: does the decision to add two or four add 33% to the loop? In most machines the overhead is a maximum of about 10%, so that this is a most worthwhile saving.

Scribbling code

At this point, most programmers have become so excited at having had a clever idea that they are already scribbling code. We are not so easily panicked however. We are not finished. We have glimpsed a generalisable principle. We have omitted divisors divisible by two and three: What about omitting divisors divisible by five? How difficult is this?

Figure 4 shows a list of numbers not divisible by two and three, with those divisible by five marked. It is not so obvious this time, but there is still a sequence. This time the sequence is eight steps long, and saves about 13% of the remaining divisors.

This sequence of eight steps does not look simple to generate. The obvious solution is to hold the sequence of divisor increments as a list. Handling this list introduces very little, if any, overhead over the previous two/four increment decision, and saves us dividing by another 13% of the remaining divisors.

We could consider omitting divisors divisible by seven ... and 11 ... — but this would be handled by extending our existing difference list procedure, and at this stage of general design I shall leave that as a detail, like the decision about the optimum size of the prime list.

Late decisions

There is a good reason for not bothering our heads with those kind of details at this stage, changes in the more general area of procedure, which we are considering at the moment, may well remove the need; or change the context, in which these details operate. This is another important principle: leave decisions as late as possible in the process of design refinement.

Figure 5 illustrates this now quite sophisticated prime factor program. It is not so

continued over page

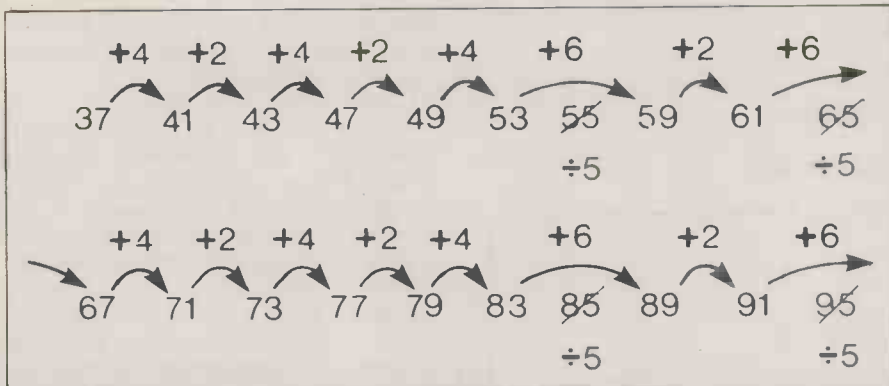

Figure 4: Omitting odd numbers divisible by 3 and by 5

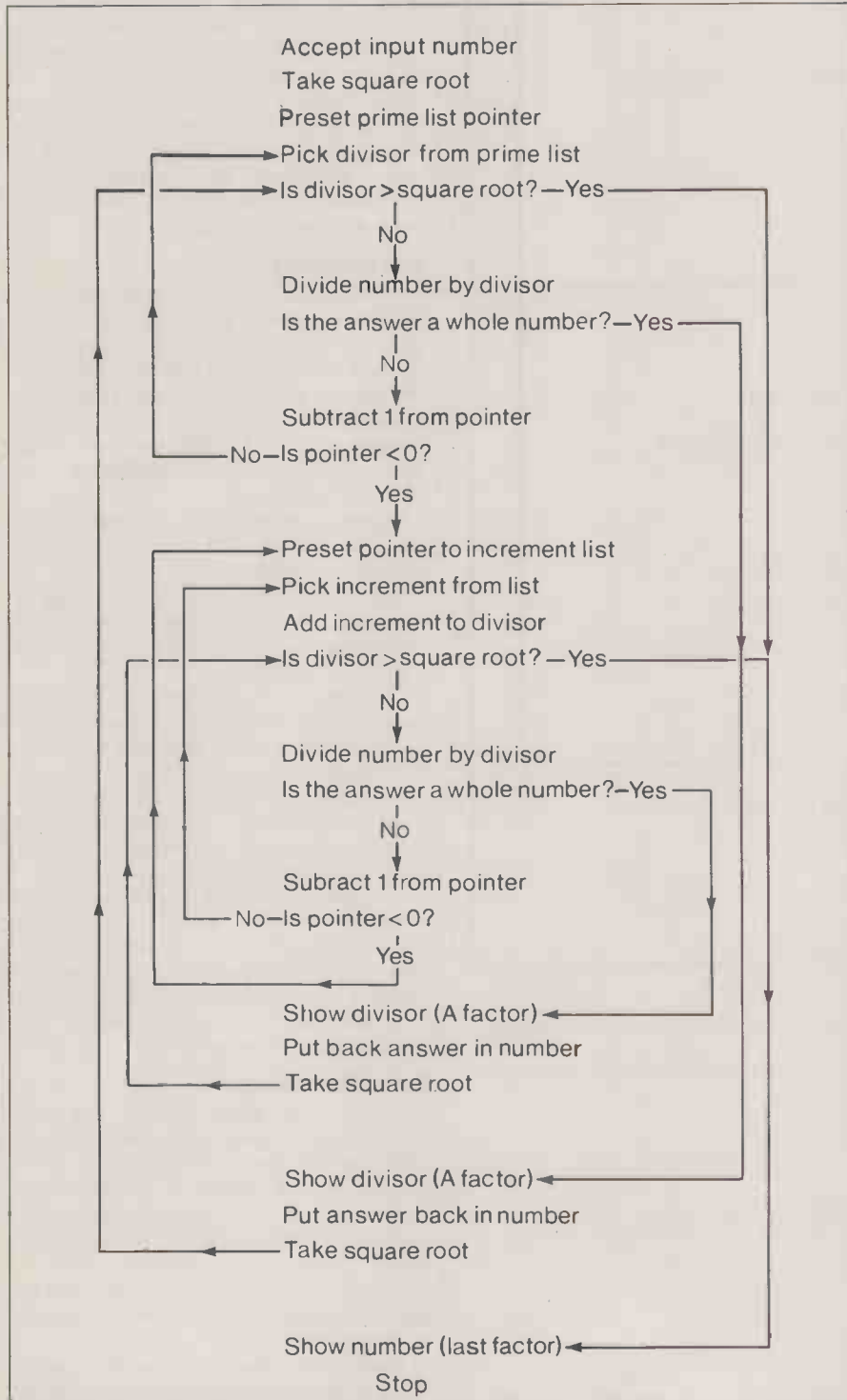

Figure 5: A fast prime factor program

from previous page

difficult, is it? Mostly a question of keeping the animal instincts at bay, while logical progressions are made.

So our algorithm now contains two loops, the first picking up prime divisors from a list, and the second generating sort of prime divisors by picking up differences from a list. The astute programmer should be wondering about the possibilities of combining these two loops, by holding the first list as differences as well.

Real primes

In fact, as the list of differences in figure 6 shows, it is quite simple. To begin with, the list of differences will be initialised from the top, to pick up the early sequence of real primes; and then the list will be initialised thereafter part way down, to pick up the repeating element that generates the further almost-primes.

This new algorithm contains all of the speed enhancing refinements we have so far discovered, and has returned to a single small loop. It is now time to consider the size of the combined prime/difference list. We have already established that a sequence of 11 differences, with a repeating element of eight, will generate all primes successfully up to 47, and thereafter will omit as divisors all divisible by two, three, and five. Try it and see if you are not sure.

If you can be bothered to try and extend this process to omit divisors divisible by seven, you will find that the repeating sequence is very long indeed. In fact, considering the amount of store so far taken up with list and program, the extension to seven will buy a few percent of speed at a cost of more than doubling the size of the program. This extension obviously is taking the design into the area of marginal improvements for large size costs.

Therefore I propose to stop at this point, omitting divisors divisible by three and five, as being a good compromise of speed and size — a minimum in the curve of size versus speed. Before coding this, however, it should be scrutinised carefully for optimisation possibilities, in the light of what we want to use it for.

Check the loop

The most important point to scrutinise is the main dividing loop. Is it possible to take anything further out of this loop? Note that we have an outer loop, of re-initialising the list pointer, which runs only an eighth as often as the inner loop. What would be the effect of taking the test for divisor exceeding the root out into the outer loop? — it is possibly the only non-essential component of the inner loop.

Two effects: the finding of factors within the inner loop speeds up, because it is shorter; and the discovery of the last factor (or primeness in a prime) is delayed by at most eight iterations of the inner loop. In other words, the moment of

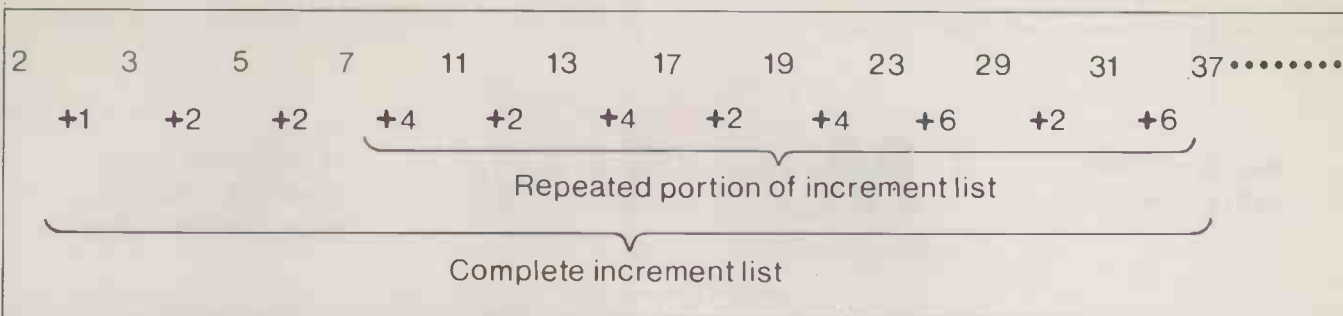
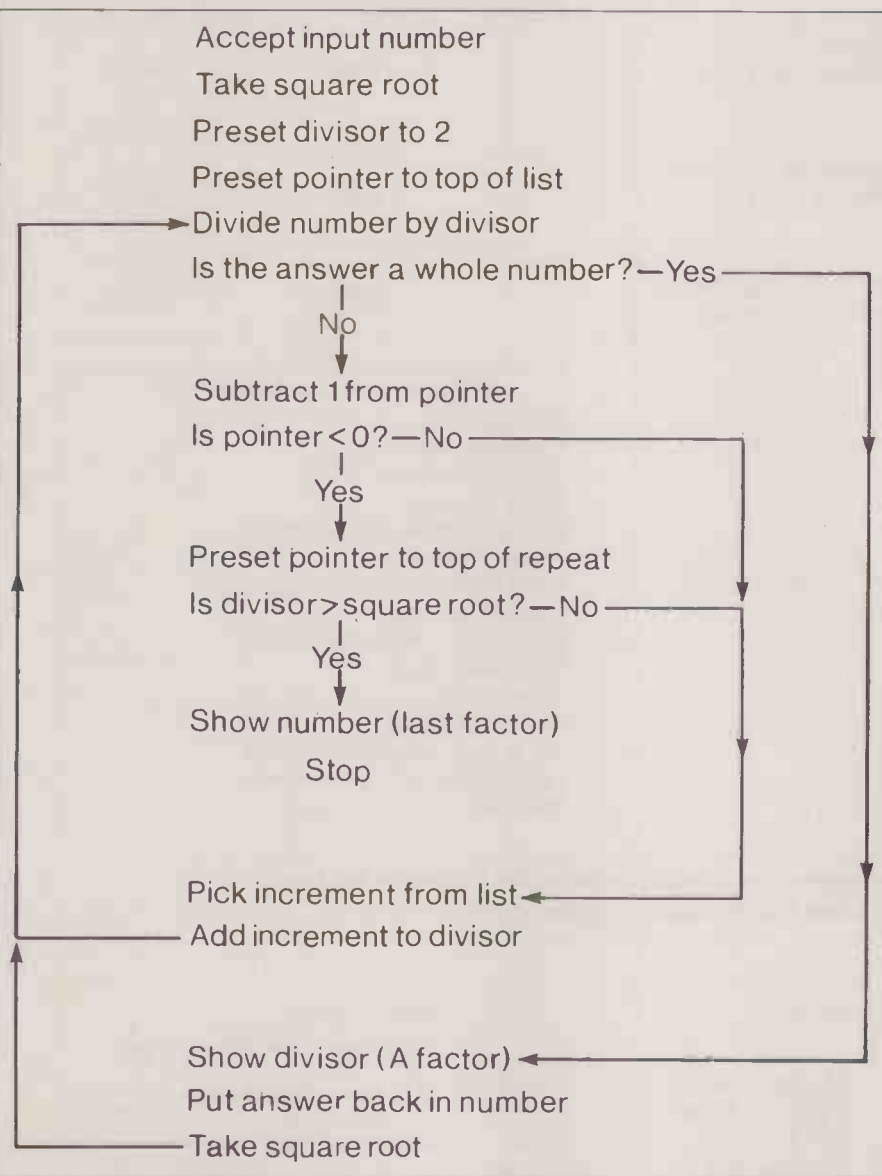

Figure 6: Generation of primes and increments from a single list



finding a factor is very slightly delayed, while the long tedious runs of the inner loop, when finding large factors or primes, is speeded up by a few percent. A few percent of hundreds or thousands of iterations of the inner loop is well worth buying at the cost of a fixed small overhead of a few iterations in showing the result — unless you are only interested in factoring small numbers, of course.

I leave it to you to adapt this algorithm for your own machine, and to compare its speed with any others you may have. As an example, I show it done in 41 steps on a Hewlett-Packard HP-29C programmable calculator, also easily adaptable to Texas machines.

I have only really begun the topic of good program design, but I hope this will get you started!

Remember the principles:
Refine the design, not the code.
Take everything possible out of the most iterated loops.
Don't code your first idea — generalised, extend, and compare.
Calculate benefits — don't optimise where it doesn't count.
Leave decisions as late as possible when refining design.
Don't code it yet!

Figure 7 (left): Even smaller, and faster too

Figure 8 (below): A program of 41 steps on an HP-29C calculator.

```

LBL 0;
STO .5; 1; 1; STO 0; 2; STO .4; (set up initial divisor and list pointer)
LBL 1;
RCL .5; RCL .4; —; FRAC; x=0; GTO 2; divide and test for integral answer
RCL (i); STO +.4; DSZ; GTO 1; increment divisor and loop on pointer
8; STO 0; RCL .5; RCL .4; x²; x<y; GTO 1; reset list pointer and test for big divisor
RCL .5; STO .4; GTO 1; set number as divisor to force out of loop
LBL 2;
Last x; STO .5; RCL .4; R/S; reset number to answer and show factor
x²; x<y; GTO 1; test for big divisor
RCL .5; R/S; show number at last factor
1; R/S; GTO 0; show 1 at end
    
```

Memory registers .1(11) → 1 contain 1,2,2,4,2,4,2,4,6,2,6

WALES LEADING
SYSTEMS HOUSE



Incorporating (Microcourier)

14 CHEPSTOW ROAD
NEWPORT, GWENT.
50528 / 841691 / 63310

At Micromedia we are usually asked for Complete Business Systems, here are a few examples.

Accounting Package Sales Invoicing / Credit Controls
Payroll on Alpha Micro, with 10 Megabyte Disk, visual
display unit and printer.

Purchase Price

17.950

Lease P/M

448.75

Purchase Accounts, Sales Accounts, Payroll on Cromemco
System III with work station, visual display unit and
180 c.p.s. printer.

7.950

198.75

Word Processing, Payroll, Accounts, on North Star Horizon
with printer visual display unit and additional monitor.

5.500

137.50

Call us for a quotation on :

Cromemco II & III

North Star Horizon

Alpha Micro

Compucolour II

Commodore Pet

S W T P 6800

Microstar 45

APPLICATION SOFTWARE

Mailing Lists
Data Base Management
Accounting Suites
Stock Controls
Simplex Linear Programming
Personel Records
Fleet Maintenance Records
Word Processing
Pert (Critical Path Analysis)
Purchase Ledger
Sales Ledger
Medical Records
These are a selection from the
range please call us to discuss
your particular application.

We specialize in systems for Business Industry and Education and have
specialist staff to discuss your applications.

Visual Display Units

	From £
Adds Regent 20	605
Adds Regent 25	645
Adds Regent 40	865
Cifer 2600	600
Dec VT 100	1100
Elbit 1920/30	725
Elbit 1920/30x	750
Infoton	610
Lear Siegler ADM 3A	595
Newbury Lab Range	From 495
Pericom 6801	985
Pericom 6802	1085
Pericom 6803	1285

Printers

	From £
Anadex DP800	575
S W T P PR 40	250
OKI E T 5200	485
Teletype 43 KSR	840
Dec LA 34	895
Dec LA 36	905
Dec LA 120 KSR	1675
Diablo 1640 RO	2098
Diablo 1640 KSR	2292
Texas 743	1195
Texas 810	1450
Tally Range from	1895

Odds 'n Sods

	£
M22 Paper Tape Reader Punch	975
M33 Paper Tape Reader	450
M63 Paper Tape Reader Punch	1495
Servogor Graphic Plotter	2750
Sigma Graphic Option Controller	2168
Single side mini Diskettes Per 10	30
Single side 8" Diskettes Per 10	35
C12 Cassettes Per 10	475
Large range of computer books send SAE for list.	

OEM TERMS & QUANTITY DISCOUNTS AVAILABLE WRITE FOR DETAILS

Start practising for the Amazing Micromouse Maze Contest

THE AMAZING Micromouse Maze contest has come to Europe, and the finals will be held in September 1980 during the Euro-micro Conference. A few changes have been made to the rules devised by IEEE Spectrum, who first ran the contest in the USA, and two new classes have been added to the contest. These are a 'free world' course in an open arena with obstacles and targets, and a 'virtuoso display', writes John Billingsley.

The maze is based on a matrix of seven-inch squares, with alley widths of six and a half inches. Maze walls are two inches high, and the mouse is allowed to bulge over the top within a ten-inch limit on length and breadth. There is no height limit, but remember that if it topples there must be no outside help. Of course, walls must not be crossed illegally.

When the contest was held in the USA, a high-speed wall-follower managed to put up an excellent time with no intelligence whatsoever. The new maze contest has its target at the centre, and the maze will be arranged to send the wall followers on a swift turn around the edges and back out of the entrance. Unlike the children's picture-book mazes, there will be many highly connected paths to the goal, some much shorter than others.

With this connectivity comes the possibility of running round and round a loop. That is where intelligence will start to score, from a simple 'haven't I been here before', to 'I must have circles the centre clockwise, so I should look for a turn to the right'. Remember that unless the mouse is equipped with a television camera or such, its only knowledge of the maze comes from remembering the walls it has touched.

To give a feel for the problem, and to give practice at developing strategies, a program has been written for the Commodore Pet. On the screen you are shown the mouse (an asterisk) and the cheese. No maze walls are shown until you explore them, by driving the mouse using the keys 4, 6, 8 and 2 as a 'joystick'. Your

MANY intending contestants may be finding difficulty with the underpinnings of their mice — the motors, and their control electronics, wheels, steering. We would draw their attention to the *Hebot* robot has been featured in the last three issues of the magazine *Hobby Electronics* (November 1979 to January 1980).

As it stands, or rather rolls, this is too wide for the Micro-mouse maze, but it could easily be reformed into a suitable shape.

Copies of the magazine are 63p each, inc. pp, from *Hobby Electronics*, 145 Charing Cross Rd, London W.C.2. A source for the hardware is mentioned.

moves are counted, and when you have painfully stumbled to the centre you can press D to display the whole maze,

A space will let you start again 'blind', whilst typing C allows you to construct or change the maze; in this case, key 5 rebuilds the walls around the current position of the mouse. At any time a maze can be written to tape using key 'W', or a new maze can be read by typing 'R'. In detail, the program runs as follows:—

1. Load and run the program. A summary of the directions is shown on the screen:
8, 4, 2, 6 as joystick, 5 to rebuild wall
Space to tray
Disclose Construct
Read Write
2. The program asks for maze dimensions. Start small with ten by ten — type 10, 10 (return).
The screen clears, the machine ponders a while, and then draws an array of squares, with an asterisk 'mouse' top left and the cheese in the middle. Now cut yourself a maze using the joystick keys. If you change your mind about a wall, you can rebuild the walls around the mouse by typing 5.

3. When you are satisfied, type 'space' to try out the maze. As you move the mouse to a new square, any right-hand or bottom walls are shown. Left-hand or upper walls appear if you try that direction, but they do not cost a move.

4. If you want to disclose the maze, type D.
5. If you want to modify the maze (ie construct it), type C.
6. If you want to try again, 'blind', type space'.
7. If you want to keep the maze for later use, type W. The Pet asks 'W. File name?'. Give it a name such as M01, so that you can later read mazes from a tape in turn with file name M.
8. If you want to read a maze from tape, type R. The Pet asks 'R. File name'. Type the file name (return), the maze will load, and you are ready to try it blind as soon as the mouse and cheese appear.
9. To start off with a recorded maze, just run the program, type in a very small maze dimension, say 2, 2, and then press R as soon as the mouse appears.

```

10 GOSUB2000
30 PRINT"008,4,2,6 AS JOYSTICK, 5 TO REBUILD WALLS"
40 PRINT"DISCLOSE TO TRY":PRINT"DISCLOSE, DISCLOSE"
50 PRINT"DISCLOSE, DISCLOSE"
100 INPUT"MAZE DIMENSIONS";IM,JM
105 IFPT=0AND(IM+1)*JM>256THENPRINT"ARRAY > 256; TRY SMALLER MAZE":GOTO100
110 DIMWZ(IM,JM):PRINT"0"
120 A=3:FORI=1TOIM:FORJ=1TOJM:WZ(I,J)=A:NEXT:NEXT
130 FORI=1TOIM:WZ(I,0)=2:NEXT
140 FORJ=1TOJM:WZ(0,J)=1:NEXT
150 GOTO000
190 IJ=D+I+L*J:A=WZ(I,J)
200 WAITP,Q,Q:POKEIJ,U:GETA$:WAITP,Q,Q:POKEIJ,A:IFA$=""THEN200
205 IN=I:JN=J
210 IFA$="6"THENIN=I+1:IT=I:JT=J:GOTO270
220 IFA$="4"THENIN=I-1:IT=I-1:JT=J:GOTO270
230 IFA$="2"THENJN=J+1:IT=I:JT=J:GOTO280
240 IFA$="8"THENJN=J-1:IT=I:JT=J-1:GOTO280
250 FORN=1TO6:IFA$=MID$("5 RWDC",N,1)THENC=N:N=6:NEXT:GOTO1000
260 NEXT:GOTO200
270 T=WZ(IT,JT)AND1:T1=1:GOTO290
280 T=WZ(IT,JT)AND2:T1=2
290 ONCGOTO300,400,500
300 IFIN=0ORJN=0ORIN<IMORJN<JMTHEIN190
310 WZ(IT,JT)=WZ(IT,JT)AND(3-T):POKED+IT+L*JT,V(WZ(IT,JT))
320 I=IN:J=JN
330 GOTO190
400 IFTHEIN420
410 I=IN:J=JN:K=K+1:PRINT"0";K;" MOVES ";INT((TI-T0)/60);" SECONDS":GOTO190
420 M=D+IT+JT*L:N=WZ(IT,JT):IFPEEK(M)=NTHEN190
430 IFPEEK(M)=V(T)THEN190
440 IFPEEK(M)=32THENPOKEM,V(T):GOTO190
450 POKEM,N:GOTO190
500 CLR:INPUT"R. FILENAME";A$
510 OPEN1,1,0,A$
520 INPUT#1,IM,JM:DIMWZ(IM,JM)
530 FORI=0TOIM:FORJ=0TOJM:INPUT#1,WZ(I,J):NEXT:NEXT
540 CLOSE1:GOSUB2000:GOTO1030
600 PRINT"0":INPUT"R. FILENAME";A$
605 IFPT=0THENPOKE243,122:POKE244,2:Z=59411:Z1=53
610 OPEN1,1,1,A$
620 PRINT#1,IM:PRINT#1,JM
625 IFPT=0THEN650
630 FORI=0TOIM:FORJ=0TOJM:PRINT#1,WZ(I,J):NEXT:NEXT
640 CLOSE1:GOTO700
650 FORI=0TOIM:FORJ=0TOJM:PRINT#1,WZ(I,J):POKEZ,Z1:NEXT:NEXT:GOTO640
700 C=2:PRINT"0"
710 FORI=0TOIM:FORJ=0TOJM:POKED+I+L*J,V(WZ(I,J)):NEXT:NEXT:T0=TI:GOTO1035
800 C=1:GOTO710
1000 ONCIGOTO1005,1030,500,600,700,800
1005 IFCC>1THEN200
1010 WZ(I,J)=3:A=V(3):WZ(I-1,J)=WZ(I-1,J)OR1:POKEIJ-1,V(WZ(I-1,J))
1020 WZ(I,J-1)=WZ(I,J-1)OR2:POKEIJ-L,V(WZ(I,J-1)):GOTO190
1030 T0=TI:PRINT"0":C=2
1035 I=1:J=1:IN=1:JN=1:POKED+INT((IM+1)/2)+L*INT((JM+1)/2),V(4):K=0
1040 GOTO190
2000 I=32810:L=40:P=59456:Q=32
2010 DIMW(4):PRINT"0":FORI=0TO4:V(I)=PEEK(32768+I):NEXT:U=PEEK(32768+5)
2020 PT=0:IFPEEK(61667)=165THENPT=1
2030 RETURN
3000 OPEN1,8,15:INPUT#1,A$,A$:PRINTA$:CLOSE1
READY.

```

Look, no hands!

C. G. CHRISTIE was interested to read of the problems of I. R. Sinclair and the remote plug on his cassette:

A month ago I took a delivery of a TRS-80 Level I which came with a CTR-80 cassette recorder. The CTR-80 has been designed for micro-computers and costs £41.95 from Tandy. The following points should be noted:

- The remote plug may be left in during rewind/fast forward. (No constant plugging/un-plugging. Neat, eh!)
- The dummy mic. plug should not be used during CSAVE. This results in blank tapes. This discovery took a lot of trial and error as the manual refers only to the old CTR-41.
- You should remove AUX plug when loading and the MIC plug when saving, as this will help reduce noise.

Debounce problem

Steve Baker has also been looking at the debounce problem (Tandy Forum, November 1979).

I had independently arrived at a very similar solution as Ed Phipps, based on the listing of A. J. Harding in your April edition — my program also crashes right at the end with a ?SN ERROR although it does seem to debounce the keyboard OK.

So armed with a homemade Hex Monitor program and a list of the Z80 op-codes, I decided to try to discover the cause of the error ... it turns out to be *your fault* for failing to spot a typo in A.J. Harding's code.

It seems that the first few instructions of the assembler patch routine load the address of the remainder of the program into the Keyboard device control block, call a routine in the Level II ROM to initialise the keyboard and then return to location 1A10 Hex which exists from the Basic program and causes Level II to print READY. This last part is given in your listing as

```
FFD7 CF191A JP 1A19
which actually does a RST 8 instruction
(which is where BASIC goes to report a
?SN ERROR I presume) so this line
should read ...
```

```
FFD7 C3191A JP 1A19; Return to
LEVEL II
```

Mea culpa! These things do happen—Ed.

Proper syntax

IN THE TANDY FORUM column in November, we published a keyboard debounce routine which apparently contained a syntax error in line 6. Laurie Heath, from New Malden in Surrey, has found the solution and has enclosed an amend DATA statement for line 3.

TRS-80 keyboard debounce correction

```
3 DATA 175,17,10,0,205,11,0,25,34,22,64,205,97,27,205,
25,26,33,54,64,1,1,56,22,0,10,95,174,115,163,32,8,20,
44,203,1,242,226,79,201,95,197,1,220,5,205,96,0,193,10,163
200,195,251,3
```

TANDY FORUM is devoted to the Tandy TRS-80. We will be using it to pass on news about the TRS-80 and its supplier and product announcements from Tandy and other vendors of compatible equipment. Above all, these are pages for users, and would-be users, of this personal computer. We want you to send tips, queries, moans and comments, and we want this page to become a market-place for TRS-80 information.



Dutch tip

ONE OF OUR DUTCH readers, R. A. Keijzer from Hilversum, has written in about the hint from Stephen Toop in the October Tandy Forum:

Stephen Toop's way of disabling the keyboard, by means of POKEing a 0 in location 16405 is great. However, this doesn't work under Disk Basic. When using Disk Basic it's necessary to POKE a value of 16 in location 16405 to get the same effect.

It's also possible to disable the display in a similar way. This is done with the following statement:

```
POKE 16413,0 under Level II Basic
or POKE 16413,16 under Disk Basic
```

This can be useful, if you want to input, for example, a secret keyword. These lines are necessary then:

```
100 POKE 16413,Y
110 INPUT A$
120 POKE 16413,7
```

When using Level II Basic, Y = 0; under DISK BASIC, Y = 16.

Using the lines 100-120 lets you input A\$ in the normal way; however, it won't be displayed. The POKE 16413,7 is used to put the display function back to normal again.

Automatic recording

W. T. COWHIG has discovered that waiting to record three or four copies of a program can be tedious. The following should make it automatic.

```
For N = 0 to 999: Next N: CSAVE "J":
for N = 0 to 444: Next N: CSAVE "J":
for N = 0 to 4444: Next N: CSAVE "J":
for N = 0 to 4444: Next N: CSAVE "J":
```

Press "enter" and return five or so minutes later and — hey presto! — four recordings will be ready. The initial delay allows the cassette recorder to settle down.

Machine artistry

I HAVE seen several programs which permit pictures to be drawn on a TRS-80 screen, and some that allow pictures to be recorded on tape, writes Mike Gardner — but they seem complicated and slow.

With this in mind he has developed the following program:

I have often seen the keys 'U', 'D', 'L', and 'R' used to cause movement up, down, left, and right respectively; my program makes use of the directional arrows to effect the appropriate movement. Further, if the shift key is held down with the appropriate direction key, a repeating movement in that direction will be obtained.

The program allows for text to be mixed with the graphics, though when in the text mode the repeating function is not used. By the inclusion of two machine-code routines, which are loaded automatically when the program is run, recording and loading the contents of the screen to and from tape is also possible, and takes approximately 21 secs regardless of the screen content.

As no instructions are included with the program, a description of its operation follows. The program is intended to run on a 16K Level II machine and will require a fair amount of modification for other sizes of memory. Before running the program, memory space should be reserved in response to the Memory Size request, the response being 32670. After entering run, there will be a short pause to load the machine-code routines, and then the screen will clear and the graphics point at (0,0) will be set; the program will now be in the Graphics Cursor Mode.

Graphics cursor mode: To return to the graphics cursor mode when in the graphics mode, press the 'C' key and the last graphics point set on the screen will become the graphics cursor.

In this mode, pressing the direction keys

Now, the complete MK 14 micro-computer system from Science of Cambridge

VDU MODULE. £33.75

(£26.85 without character generator) inc. p & p.

Display up to 1/2K memory (32 lines x 16 chars, with character generator; or 4096 spot positions in graphics mode) on UHF domestic TV. Eurocard-sized module includes UHF modulator, runs on single 5 V supply. Complete ascii upper-case character set can be mixed with graphics.

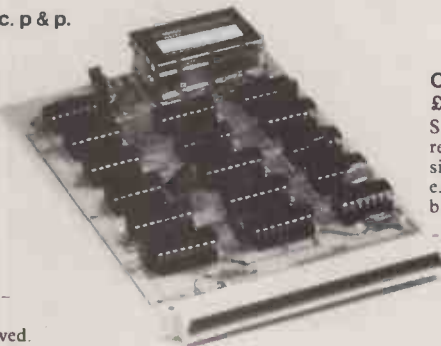

CASSETTE INTERFACE MODULE. £7.25, inc. p & p.

Store and retrieve programs on any cassette recorder. Use for serial transmission down single line at up to 110 baud (teletype speed), e.g. over telephone line, and to communicate between two or more MK 14s.



POWER SUPPLY. £6.10 inc. p & p.

Delivers 8 V at 600 mA from 220/240 V mains – sufficient to drive all modules shown here simultaneously. Sealed plastic case, BS-approved.



MK 14 MICROCOMPUTER KIT

£46.55 inc. p & p.

Widely-reviewed microcomputer kit with hexadecimal keyboard, display, 8 x 512-byte PROM, 256-byte RAM, and optional 16-lines I/O plus further 128 bytes of RAM.

Supplied with free manual to cover operations of all types – from games to basic maths to electronics design. Manual contains programs plus instructions for creating valuable personal programs. Also a superb education and training aid – an ideal introduction to computer technology.

Designed for fast, easy assembly; supplied with step-by-step instructions.

PROM PROGRAMMER. £11.85 inc. p & p.

Use to transfer your own program developed and debugged on the MK 14 RAM to PROM (74S571) to replace SCIOS monitor for special applications, e.g. model railway control. Software allows editing and verifying.

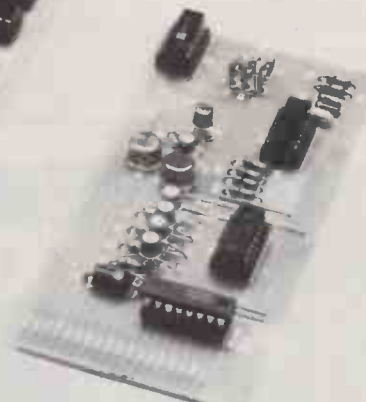

To order, complete coupon and post to Science of Cambridge
Return as received within 14 days for full money refund if not completely satisfied.

To: Science of Cambridge Ltd, 6 Kings Parade, Cambridge, Cambs., CB2 1SN.

Please send me:

- MK 14 standard kit @ £46.55.
- Extra RAM @ £4.14 per pair.
- RAM I/O device @ £8.97.
- VDU module including character generator @ £33.75.
- VDU module without character generator @ £26.85.

- Cassette interface module @ £7.25.
- PROM programmer @ £11.85.
- Power supply @ £6.10.
- Full technical details of the MK 14 System, with order form.

All prices include p+p and VAT.

I enclose cheque/MO/PO for £ _____ (total).

Name _____

Address (please print) _____

PC/2/80

Science of Cambridge Ltd

6 Kings Parade, Cambridge, CAMBS., CB2 1SN.
Tel: 0223 311488.

• Circle No. 201

```

10 DEFINT A,C,S,X,Y
20 POKE 16553,255
30 FOR A=32672 TO 32758:READ X:POKE A,X:NEXT A
40 DATA 243,62,2,205,18,2,205,135,2,33,2,60,1,2,4,126,229,197
50 DATA 205,100,2,193,11,62,0,184,202,195,127,225,35,126,195
60 DATA 176,127,185,194,189,127,205,248,1,251,201,243,62,2
70 DATA 205,18,2,205,150,2,33,2,60,1,2,4,229,197,205,53,2,193
80 DATA 225,119,35,11,62,0,184,202,238,127,195,219,127,185
90 DATA 194,219,127,205,248,1,251,201
100 CLS
110 S=1:C=1:X=0:Y=0:SET(X,Y)
120 IF PEEK(14464)=1 GOSUB 490
130 AS=INKEYS:IF AS="" THEN 130
140 A=ASC(AS)
150 IF A=91 GOSUB 410 :GOTO 120
160 IF A=10 GOSUB 430 :GOTO 120
170 IF A=8 GOSUB 450 :GOTO 120
180 IF A=9 GOSUB 470 :GOTO 120
190 IF A=31 THEN CLS:GOTO 110
200 IF AS="S" THEN S=1:C=0:SET(X,Y):GOTO 120
210 IF AS="R" THEN S=0:C=0:RESET(X,Y):GOTO 120
220 IF AS="C" THEN S=1:C=1:GOTO 120
230 IF AS="T" GOSUB 550 :GOTO 110
240 IF AS="P" THEN 270
250 IF AS="I" THEN 300
260 GOTO 120
270 POKE 16526,160:POKE 16527,127
280 A=USR(0)
290 GOTO 110
300 POKE 16526,204:POKE 16527,127

```

will move the cursor one graphics position in the direction chosen. By depressing both the shift key and a direction key, and keeping them depressed, repeated rapid movements of the cursor in the chosen direction will be achieved.

Complete wrap-round of graphics is always maintained.

Graphics set mode: When in the graphics mode, to enter or return to the graphics set mode, press the 'S' key.

In this mode, use of the direction keys and repeating function is as for the cursor mode, but this time all movements of the cursor will leave all previously set points in the set state. This allows lines to be drawn on the screen. Diagonal traverses are not supported and will have to be built up by careful use of the cursor mode and set mode.

Graphics reset mode: When in the graphics mode, to enter or return to the reset mode, press the 'R' key.

This mode is similar to the set mode, except previously set points will be reset.

Graphics clear: When in the graphics mode, pressing the 'CLEAR' key will clear the screen and cause it to return to the graphics cursor mode with the cursor at position (0,0).

Graphics print: When in the graphics mode, pressing the 'P' key will cause the contents of the screen to be recorded on

A professional printer-

200 c.p.s.
(bi-directional)

**12 month
warranty**

ONLY
£995*
+ VAT

MANNESMANN

*End user, quantity one, cash with order price.

tape; the user should make sure the recorder is ready before pressing this key.

Graphics input: When in the graphics mode, pressing the 'I' key will cause previously-recorded data to be read in from the tape and displayed on the screen, overwriting what was there before. This routine requires all 1024 bytes to be read; if a byte is missing, the program will hang up. Rewinding the tape and playing it again should overcome this, although the display will be corrupt, and you will be returned to the graphics cursor mode.

Graphics to text: When in the graphics mode, pressing the 'T' key will cause entry to the text mode.

Text mode: When in this mode, pressing the 'CLEAR' key will return to the graphics cursor mode with the cursor at position (0,0).

In this mode, the direction keys should be used with the shift key depressed and will move the text cursor one text position in the direction chosen, at each pressing. Any graphics in the path of the cursor will be restored after the cursor has passed by. Pressing all other keys in this mode will print their appropriate characters; the 'CLEAR' key is used to return to graphics cursor mode.

Once having mastered the use of the various modes of the program, the user should find it very easy to produce pictures on the screen. 

```

310 A=USR(0)
320 GOTO 110
330 IF S=1 THEN 350
340 GOSUB 360 :RESET(X,Y):RETURN
350 GOSUB 360 :SET(X,Y):RETURN
360 IF X>127 THEN X=0
370 IF X<0 THEN X=127
380 IF Y>47 THEN Y=0
390 IF Y<0 THEN Y=47
400 RETURN
410 IF C=1 THEN RESET(X,Y)
420 Y=Y-1:GOSUB 330 :RETURN
430 IF C=1 THEN RESET(X,Y)
440 Y=Y+1:GOSUB 330 :RETURN
450 IF C=1 THEN RESET(X,Y)
460 X=X-1:GOSUB 330 :RETURN
470 IF C=1 THEN RESET(X,Y)
480 X=X+1:GOSUB 330 :RETURN
490 IF PEEK(14464)=0 THEN RETURN
500 IF PEEK(14400)=8 GOSUB 410 :GOTO 490
510 IF PEEK(14400)=16 GOSUB 430 :GOTO 490
520 IF PEEK(14400)=32 GOSUB 450 :GOTO 490
530 IF PEEK(14400)=64 GOSUB 470 :GOTO 490
540 GOTO 490
550 POKE 16416,0:POKE 16417,0:PRINT CHR$(14):
560 AS=INKEY$:IF AS="" THEN 560
570 IF ASC(AS)=31 THEN PRINT CHR$(15)::RETURN
580 PRINT AS:
590 GOTO 560
600 END

```

within your reach!

The M80-MC 80 column printer from Mannesmann Tally

Higher reliability, longer life, faster operation... that's the M80-MC.

It may cost just a little more than some "personal computer" printers, but it offers a whole lot better value.

When other cheaper printers come to a halt in the middle of a heavy work load, the Mannesmann Tally M80-MC carries on. It's a proven, 200 c.p.s. bi-directional printer which is based on micro-processor electronics—hence the low price.

- * 80 column, 200 c.p.s., bi-directional, 7 x 7 matrix (64 character U.K. set).
- * Industry standard parallel interface—compatible with all popular microcomputers.
- * Simple DIY installation.
- * Only £995 + VAT (includes Securicor delivery).
- * 12 month comprehensive Warranty (return to factory); fixed price repair service thereafter.

- * Field service agreements available from our own nationwide maintenance organisation.
 - * Options include:- 16.5 c.p.i. condensed print, 9 x 9 matrix, 96 c. set, serial interface, etc.
- Applications assistance is only a 'phone call away.



**MANNESMANN
TALLY**

Send coupon for more details.
Tally Limited, Tally House,
7 Cremyll Road,
Reading,
Berks. RG1 8NQ.

Please send further details on the M80-MC to:-
Name _____
Address _____
Dept. C.E. _____

• Circle No. 204

Critics convince Commodore

COMMODORE have finally given in over the much-criticized calculator style keyboards, writes Julian Allason of Petsoft. Future shipments of 8K PETs will feature typewriter style keyboards — and the revised ROM set. Also new will be moulded plastic cases instead of the original steel case. There are rumours, too, of a third ROM upgrade which will include a revised DOS. This is said to simplify the rather complicated existing system.

Arguments about the pros and cons of Commodore and Petsoft disk systems abound. At present the latter, manufactured in California by CompuThink, outsells the CBM unit which has been in short supply. However, teething problems due to overheating appear to have been overcome on the Commodore system. Dealers report that the 400K and 800K Petsoft drives are going more to businessmen who need the extra speed and additional storage.

The trend appears to be for the 360K Commodore system to be sold somewhat more into schools and scientific establishments. Both systems are well supported by applications software.

There is in fact a third system on sale, the Petdisk by Analog Electronics. This is the original side-saddle unit which mounts on top of the PET with one drive on either side. First seen on the Commodore stand at Compec last year, there is still comparatively little software available for the system.

Anyone interested in discovering the authorship of the new ROM system software can have their curiosity satisfied by executing WAIT 6502,0.

Despite reports of a freeze in the appointment of new dealers, the number of retailers selling the PET has risen to some 220. Not all of them obtain their PETs from Commodore, an increasing number being shipped from the States, and the power supplies converted in this country. Discounts of up to 20% are being offered by some of these "unofficial" dealers.

What, no programs?

I HAVE FREQUENTLY searched through *Practical Computing* for compilers on cassette for languages other than BASIC for the PET. I have found such programs for the TRS-80 but none for the PET. Are there such programs as CP/M, Fortran, and Pilot available for the PET?, asks K. Keyle from Wigan.

If the availability of such packages is indeed as limited as the lack of advertisements suggests, it seems a pity, since the PET is clearly a very popular micro-computer.

Please read quickly

IN DECEMBER we published the listing of a splendid game called *Star Trader*. In ignorance, we failed to acknowledge its original appearance in the book *What to do after you Hit return*, published by People's Computer Co. Sorry about this.

Revenge yourself on PET

MAURICE FOZZARD of Southend writes: This particular game was devised to show the inability of Pet to learn from previous mistakes, to demonstrate the advantage of unorthodox play, and to show that a "points greedy" computer can be outfoxed quite easily.

Pet owners who wrestle with Peter Jennings's *Microchess 2* may like to revenge past defeats with this quick game at level 8. Has anyone managed to beat level 8 using fewer moves?

WHITE	PET RESPONSE (BLACK)	
D2-D4	Queen's pawn gambit	G8-F6
D4-D5	Push Pawn forward	D7-D6
C2-C4	Protect forward Pawn's position	C8-F5
B1-C3	Bring out Queen's Knight	B8-D7
G1-F3	Bring out King's Knight	B7-B6
F3-D4	Attack black Bishop	F5-G4
D1-A4	Queen's Knight pinned	A7-A5
A4-C6	Reinforce pin	A8-A6
C3-B5	Bring up cavalry!	E7-E6
B5-C7	Check!	E8-E7
C7-A6	Capture Queen's Rook	D7-E5
C6-B7	Check!	D8-D7
D4-C6	Check!	E5-C6
D5-C6	Pawn captures Knight, attacks Queen	D7-B7
C6-B7	Pawn captures Queen	F6-D7
C4-C5	Sacrifice Pawn	D6-C5
C1-F4	Bring out Bishop	E6-E5
F4-E5	Sacrifice Bishop	D7-E5
B7-B8	Pawn promoted to Queen	E5-C4
A1-D1	Move up Rook	C4-B2
B8-D6	Queen checks	E7-E8
D6-D8	You win!	

Pet tape cure

AS ANY PET user knows, the most annoying part of loading from cassette is waiting for the FOUND '-----' message, writes R. Cason.

This is mainly due to the lack of a tape counter, but even with a counter you would not know if the PET had passed the Program Header. You can sometimes miss the header — wait several minutes — only to find you are on blank tape.

My method is as follows:

Connect a Soundbox to the user Port Pin 6 (Cassette No. 1 Read) The Soundbox connection is Pin M (CB2 Line).

On both SAVE and LOAD you can then hear the following:

- The Header Tone
- The Header Token
- The Header 'Title'
- The Program DATA
- The 'Half Way Point'
- Second copy of DATA
- The end of file Token

By using the F.FWD, PLAY and REW keys you can then locate the header on a multi-program tape — Press Play — and

wait. If you do not get the message FOUND '-----' at the Header Title stage, rewind slightly and try again. Using this method you can CUE the tape to the right position.

Other advantages are that you can also hear:

- DROPOUTS
- CROSTALK
- NOISE
- VARIATION in PITCH due to tight Cassettes.
- The difference between DATA and PROGRAM tapes.

This is an invaluable aid, and is best implemented by fitting a small toggle switch to the cover of the user port connector.

- i.e. Position SOUND (Pin M)
Position 2 OFF (No Connection)
Position 3 CASSETTE (Pin 6)
With Pin N being the 'earth'.

For those who like to keep a 'Working Copy' of their programs in addition to the 'MASTER' a separate cassette is an advantage.

I use an Hitachi TRQ 299 which has an automatic level control (ALC) and a Cue and Review facility. In my case the ALC gives perfect results on the PET recordings every time. The Cue and Review facility allows you to fast wind using Cue to find the 'nth' program on the tape.

Position the header using Review and transfer the tape to your PET Cassette.

Perhaps somebody will devise a method to convert the PET Cassette to 'Cue and Review'.

Incidentally can anybody suggest a method of recovering data from a Program tape, on which the header and part of the first copy of DATA has been erased? (Caused by pushing RECORD instead of PLAY).

Fingertip fade

CLIVE HAND, who bought his PET in October 1978, notes that: as any 4K or 8K Pet owner knows, keytops don't die, they just fade away.

I noticed my keytops slipping away after two or three months' use. The answer is at your fingertips. First you must remove the plastic film which covers each key, when first bought. Then paint a layer of nail varnish over each keytop. Obviously you must use a clear varnish.

Two thin layers should work. Experiment before actually painting, because the varnish will dry very fast. Beware of dust and take care when painting the 'SPACE' and 'RETURN' key.

I can't say I admire the idea of using a new set of keytops, or even sticky tape. I painted my keys nine months ago, and I haven't had any fading whatsoever since, and don't expect any. Possibly the suppliers of Pets could perform this simple task before selling a Pet.

The Exidy Professionals

The Exidy Sorcerer is now one of the leaders in the world of micro-computers, being equally at home as an 8K cassette based system, or expanded to 48K with dual 315K disc drives and running CP/M, Microsoft BASIC, C-BASIC, FORTRAN, COBOL, ALGOL, etc. The Word Processor must be the best available in the price range and compares very favourably with purpose built word processors costing twice as much — do not confuse with other widely advertised but inferior packages on other machines! The video/disc combines dual disc drives together with a high quality display screen, all in one neat, compact unit.

SYSTEM 1 — Word Processing & Business

- 32K Sorcerer
- Video/disc unit
- Daisy wheel printer
- Word Processor PAC
- CP/M

£4150

SYSTEM 2 — Low Cost Disc System

- 32K Sorcerer
- VDU monitor (green)
- 315K single disc
- Daisy wheel printer
- Word Processor PAC & CP/M

to be
announced —
approx.
£3200

SYSTEM 3 — General Business Applications

- 48K Sorcerer
- Dual disc drives (630K)
- BD-80 matrix printer
- VDU monitor (green)
- Disc extended BASIC

£3250

SYSTEM 4 — Cassette based Word Processor

- 16K Sorcerer
- IBM Golfball printer
- TV monitor screen
- Cassette recorder
- W/P & BASIC ROM-PACS

£1675

SYSTEM 5 — Minimum System

- 8K Sorcerer
- TV monitor screen
- Cassette recorder
- BASIC ROM-PAC

£775

VAT to be added to all prices.
Full price list on application.
Most items in stock.

SPECIAL — Daisy Wheel Printer

For the first time you can buy a quality daisy wheel printer for a reasonable price. These printers are made by RICOH and are sold elsewhere for over £2000. They are built into many brands of expensive word processors.

We are supplying these printers together with a Centronics TM interface for direct connection to Sorcerer, Tandy, Apple etc.

Contact us for further details.

RS232 serial interface also available.

Tractor feed £200 extra.

only £1450!! + VAT
(Friction feed version)

Software — the key to success

Disc Based

Microstock — stock recording	£125 + VAT
Incomplete Records Accounting	£350 + VAT
Purchase Ledger	£125 + VAT
Sales Ledger	£125 + VAT
+ programming to your own specifications at reasonable rates.	

Cassette based — 'Sorcerers Apprentice'

LINK programmes together	£10.35 inc. VAT
DRAW on screen	£4.60 inc. VAT
STATS statistics package	£17.25 inc. VAT
CBOOK chequebook	£13.80 inc. VAT
PLOT 3 graph plotting (hi-res)	£6.90 inc. VAT
+ many others (send S.A.E.)	

All the above are available from these two Exidy Professionals:

Basic Computing
Oakworth Rd, Keighley,
W. Yorkshire BD22 7LA
Tel: (0535) 65094 — Mike Collier

Micropute
Communique Place, 9 Prestbury Place,
Macclesfield, Cheshire
Tel: (0625) 612818 Telex 666971
— Don Cooper

• Circle No. 205

You're invited to come and see the
Pet™ BUSINESS SYSTEMS

at your official
COMMODORE  and **Petsoft**
 dealers in ... *Stockton-on-Tees*

Combine the NEW large keyboard PET with the ACT PETSOFT Professional Disk Systems and Software, and the result is a powerful business tool. If your application includes Sales Ledger, Invoicing, Purchase Ledger, Payroll or Stock Control, then come and see us without delay.

Intex (Datalog) Limited

Eaglescliffe Industrial Estate, Eaglescliffe
 Stockton-on-Tees, Cleveland TS16 0PN England
 Telephone Eaglescliffe 781193 (STD Code 0642)
 Cables Intextrad, Stockton-on-Tees, Telex 58252



• Circle No. 206

DDM HOBBY CORNER
 Reconditioned Olivetti Printers incl. paper tape reader/punch and transmission £250
 VDUs - 2000 ch buffered screens and Honeywell keyboards £225
 Honeywell keyboards alone £180

DDM DIRECT DATA MARKETING 44 High Street, Brentwood, Essex CM14 4AJ. Tel. (0277) 229379

DDM MICROCOMPUTING

commodore
 Business Software
 Word Processing, Payroll, and Mailing Systems.

PET Growth Products
 Disk Systems
 Computhink Dual Drives
 400 (Old Rom)
 800 (New Rom)
 Interfaces
 DDM's IEEE to RS232 bidirectional interface

original
 Printers
 Epson LA34 Dcwriter tractor feed £825
 Microsense  Disk Drive with Controller £905
 Apple II 16K
 Apple II 32K
 Disk Drive without Controller £750
 Corvus II Fixed Disk (10 Meg) £888
 £898
 £355

New  Software
 Payroll, Stock Control and Comprehensive Accounting Systems.
 Full product list available on application
 Please return the coupon for more details.

SEND DIRECT TO DDM FOR PRODUCT LISTS & FURTHER DETAILS.

DDM POSTAL

ALL PRICES EX. VAT.

NAME.....
 COMPANY.....
 ADDRESS.....
 PHONE.....
 CURRENT MICRO.....
 PRODUCT INTEREST.....

commodore
 Pet
 Pet 2001-8
 Pet 2001-16N
 Pet 2001-32N
 IEEE to Pet Connector
 IEEE to IEEE Connector
 C2N Cassette Deck

£550
 £195
 £195
 £195
 £195
 £195

• Circle No. 207

High-speed stepper motors and the PET

THE COMBINATION of a computer and a stepper motor gives us one of the most precise methods of producing and controlling rotary and linear motion. Stepper motors come in all sizes, from the small motors used in calculator printers to multi-horsepower motors for use in computer-numerically-controlled (CNC) machine tools.

The ease with which a stepper motor can be controlled by a microprocessor based computer like the PET makes it an ideal subject for experimentation, especially for those interested in robotics.

A stepper motor is totally different in design from an ordinary electric motor, which is characterised by its continuous motion when energised. The shaft of a stepper motor, on the other hand, moves in small incremental angular steps on command and will maintain this position between commands.

To achieve this, the rotor consists of a permanent magnet with alternate poles magnetised around its periphery. The stator consists of a set of coils which can be magnetised under control of external electronics. Motion is produced by the alternate attraction and repulsion of the permanent magnet and the coils the rotor moving to the position of greatest magnetic attraction — a position which it will hold until the coil magnetisation is changed.

In a previous article in *Practical Computing* (April and May 1979), we looked at some methods of controlling stepper motors. However, the results were severely limited in both power and speed, being confined to just a few tens of steps per second.

The reason for this is that the designs were based on simple drive electronics which utilised only a small part of the start/stop operating curves for a given motor. These curves give the motor torque for a given speed at which the motor may be stopped or started instantaneously without loss of command position.

Cash limits

Beyond this curve is another, termed the slew curve, which, depending on motor and drive, may extend to thousands of steps per second. This is possible by accelerating the motor field up to and down from the high speed. The limit on these step rates is eventually the motor, but the drive cost also becomes an important consideration for the home user. So here we will consider high speeds as being in the motor's slew region, up to a

maximum of 5000 steps/sec, and a drive price of approximately £25.

There are many different types of motor, with varying numbers of steps/revolution. The motors driven and described here are four-phase hybrid stepping motors with 200 steps/rev. The motor phases (coils) may also be sequenced differently to produce the normal 200 steps or half-stepped to give 400 steps. The drive card used does this and all references to the step pulses assume 400 steps/rev.

Torque versus speed

The torque available will, as already stated, depend on the motor and drive combination. In figure 1 we see speed-torque curves for a 22 frame size motor driven from APKS 1186 drive card. The lowest curve is the start/stop curve, the upper curves represent the torque available when the field is accelerated.

If the motor is driven from its nominal voltage with no external resistors and a coil energised, the current will rise exponentially. The rate of rise is a function of the winding resistance and inductance. To reach 95% of full current will take 3LR.

If, however, we double the voltage and fit a series resistor equal to R, the time to reach the same current will only be 1.5LR, due to the time constant for the exponential being halved.

As the total resistance is doubled, the motor current remains the same but switching times are improved, allowing current to be maintained in the coils at higher step frequencies.

With the PKS 1186 drive card at nominally 24 volts, and a 6 volt 22 frame size motor, we have the L/2R torque curve. This may be extended to the L/4R curve by increasing the drive voltage to 48 volts if required.

Higher voltages and larger resistors are possible but losses are also high. More sophisticated drives, such as the PKS 1054, overcome this by current regulation. With this technique step frequencies of 20,000 steps/sec. (3000 RPM) may be achieved.

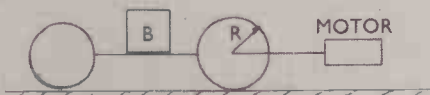

System torque calculations

Often the rotary motion of the motor shaft has to be translated into a linear movement. The most common forms are

a wheel moving along a surface, or a screw thread driving a nut. The torque required to drive such systems may be calculated and a motor chosen from its torque curve.

1. Wheel drive

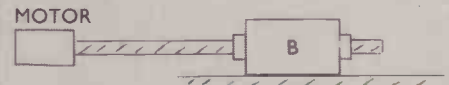

B = weight of system kp.

R = radius of wheel cm.

M = mass of wheel kg.

Inertia of wheel $JW = M \cdot R^2 / 2$ kp/cm²

Effective inertia of weight $JE = B \cdot R^2$ kp/cm²

If velocity = V cm/sec,

then angular $VEL W = V / 2 \cdot \pi \cdot R$ rev/sec.

If the motor is driven at 400 steps/rev, then clock frequency =

$(400 \cdot V) / (2 \cdot \pi \cdot R)$ Hz

If JM = motor inertia

TS = time to accelerate the system, then total inertia $JT = JM + JW + JE$

Torque $T = JT \cdot 400V / 2R \cdot TS \cdot 0.9 / 180 \cdot 1.021 / 1000$ kp/cm

Here friction has been assumed to be negligible. If this is not so, add the frictional load to T for the total value.

B = weight kp

P = pitch of screw mm/rev

E = efficiency of screw in %

Note:— The efficiency of a normal acme screw is only 35-45%. For best results a ball screw or acme screw with low friction nut (PTFE) should be used. The efficiency will then be greater than 80%.

Linear speed mm/sec = (steps/sec)/(steps/rev) * 60 * P * 1E-3

Axial force kp = $62.8 \cdot T / P \cdot E$

I = torque kp/cm

Rotational equivalent of weight

$JE = B \cdot P^2 \cdot 2.53 \cdot 1E-4$ kp/cm²

The inertia of the screw

$JS = D^4 \cdot L \cdot 7.721E-4$ kp/cm²

D = diameter of screw cm

L = length of screw cm

Note: The factor 7.72 assumes a steel screw.

As before, the total inertia $JT =$

$JM + JE + JS$

Where JM = motor rotor inertia

therefore if V = velocity in mm/min

step frequency $SF = (V \cdot 400) / (60 \cdot P \cdot P \cdot 1E-3)$ at 400 steps/rev

torque $T = JT \cdot SF / TS \cdot 9.9PI / 180 \cdot 1.021 / 1000$ kp/cm²

where IS = time to accelerate the system, torque to overcome friction F

$TF = F \cdot P / 62.8 \cdot E$ kp/cm²

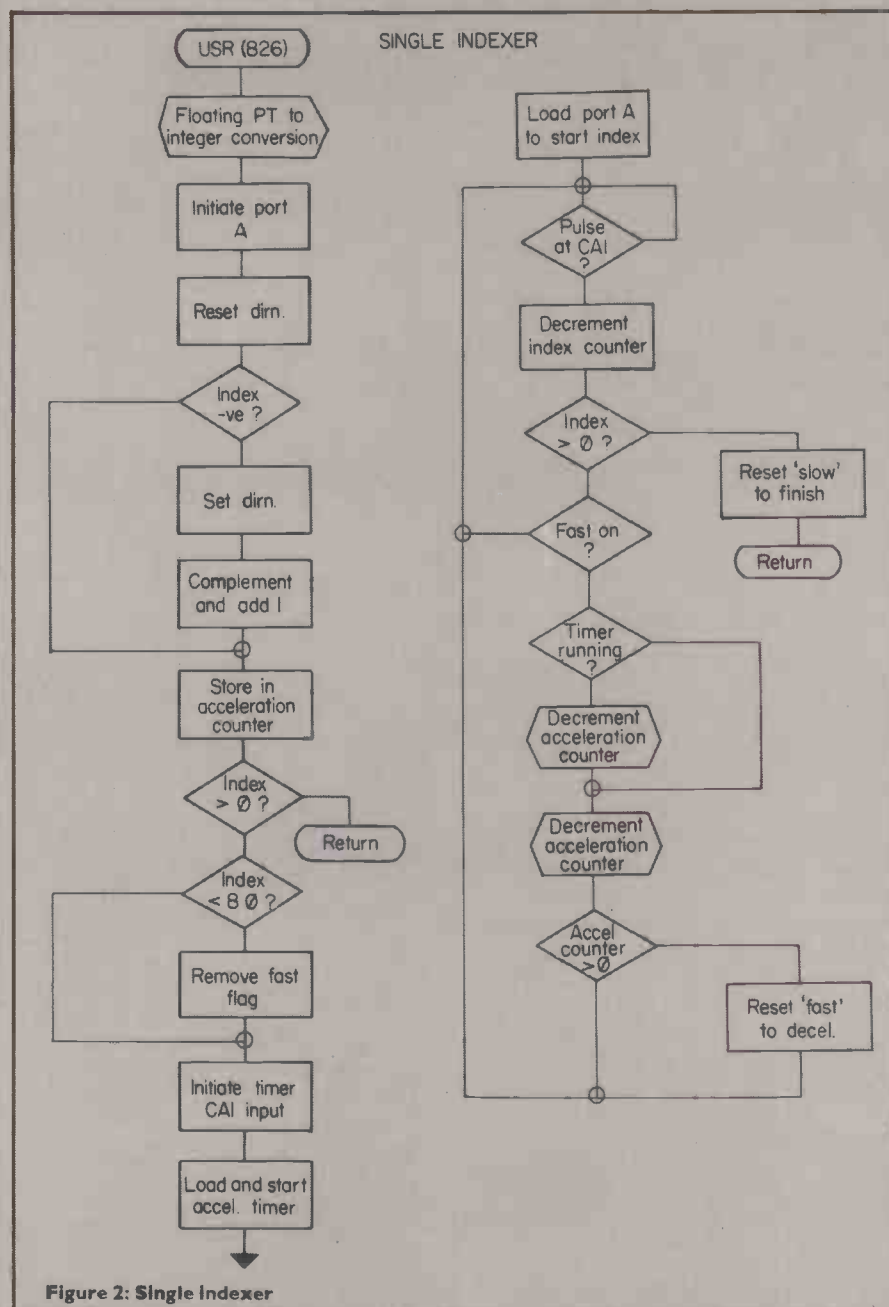

Figure 2: Single Indexer

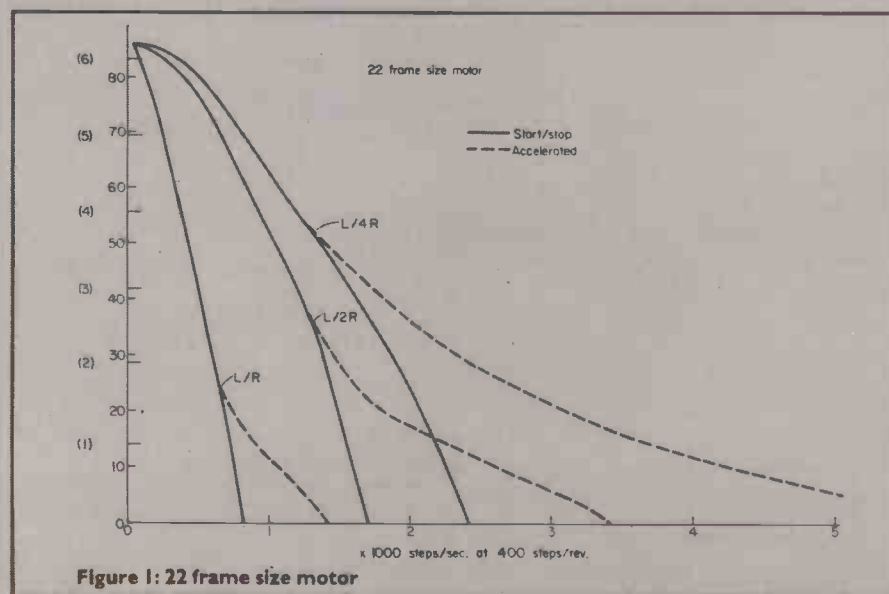

Figure 1: 22 frame size motor

The total torque is then the sum of these two torque values.

Gearing

Gearing of the motor to the load can be advantageous. Any gearing multiplies the motor torque by the gear ratio (G), but divides the effective inertia by the gear ratio squared (G^2). This therefore improves the loading of the motor, but requires G times the motor speed to keep the system speed the same. Gearing will always incur some losses and more motor torque is required to make this up. Despite this, advantages are to be gained from gearing, and where possible the effective inertia of the system should be equal to the motor's rotor inertia for maximum power transfer.

Drive card

The drive used here is a PKS 1186 bipolar L/R drive. The coils of the motor are driven from two bridges of four transistors each, the four coils being wired as two pairs. The use of a bridge enables the current to be driven through the coils in either direction (figure 6).

The oscillator to step the phases is incorporated on the card. Two inputs control this oscillator and are termed 'fast' and 'slow', variable resistors setting the frequency. The 'S' input gives frequencies in the range of the start/stop curve and thus will instantaneously produce and terminate motion. The 'F' input runs the oscillator into the motor's slew region and here the clock is accelerated, or ramped. This ramping is fixed by a capacitor on the card, but the acceleration time may be increased by addition of further capacitance. The sequence of the phase switching is controlled by the card with the 'dirn' input governing the stepping direction of the motor.

The card operates, and derives its cmos 12 volts, from one supply which is nominally 24 volts. No other supplies are necessary for operation.

Indexing

The algorithm used to control the positioning of the motor uses two counters and a timer. The timer is set to time the period in which the motor is accelerated, and this combined with one of the counters gives the deceleration point. This point is required to allow enough time, or steps, in which to decelerate the motor to a frequency at which it may be stopped without loss of rotor synchronisation.

During the timer period, the acceleration counter (AC) will be decremented from the total index value twice for each motor step pulse. The other counter, index counter (IC), is decremented only once for each pulse.

We start the index by loading AC and IC with the number of steps to run. The timer is loaded with the time taken to reach full speed. 'Fast' and 'slow' are

taken low to start the clock and the timer initiated. For each step pulse $AC = AC - 2$ and $IC = IC - 1$, in basic syntax. This will continue until the timer times out or $AC = 0$. If $AC = 0$ we must have been constantly accelerating and moved half the distance.

If this is so, we will arrive at $IC = 0$ if we now decelerate at the same rate. If the timer times out we start to decrement AC only once for each step pulse as IC . When AC now reaches zero, and if we had reached full velocity before the timer finished, then we have a difference between IC and AC that is equal to the acceleration distance. Thus if we decelerate at this point, we will again reach zero speed as $IC = 0$.

In practice we know that the motor in its start/stop region I.E. 'slow', may be stopped instantaneously without error. This being so, we decelerate to 'slow' and run to the end, $IC = 0$, at slow speed. Zero on AC controls the 'fast' input to the drive, removing 'fast' when $AC = 0$. Two profiles for a short index, $AC = 0$ before timeout, and a long index are shown in figure 4.

Computer implementation

To implement the indexing algorithm on a computer, the counters become consecutive memory locations and the timer may be an interrupt-driven counter or a hardware counter controlled by software.

The listings shown here are for a Pet computer using the 6522 via to give the timer function and port I/O's for drive card control.

The first listing and flow-chart shows a single-axis control direct from a basic program with the index value passed by the `USR` function. This allows ± 32767 steps as the index range, the value converted from a floating point number to an integer by the `$D0A7` subroutine. If a negative value is passed, the 16-bit integer is complemented and 1 added to find the absolute value and the direction output is set.

The timer values `TL` and `TH` are set by the program but may be modified with poke commands to 1013 and 1014.

The use of 'fast' to control the step pulse oscillator leads to a small problem for short indexes. When 'fast' is applied, the acceleration capacitor immediately starts to charge, so even if 'fast' is removed quickly, the clock will output pulses after 'fast' has gone. This gives extra pulses on these small moves. To overcome this, the index is checked for a value of (80 steps). If so, the index is performed with 'slow' only.

The remainder of the flow diagram is that of the indexing algorithm. The pulses generated are flagged by their negative edges in the 6522 IFR AS CA1 transitions. The program loops on this test waiting for a result. This gives a 7usec response to 'interrupt' where as if the `IRQ` interrupt was used, a large overhead would be in-

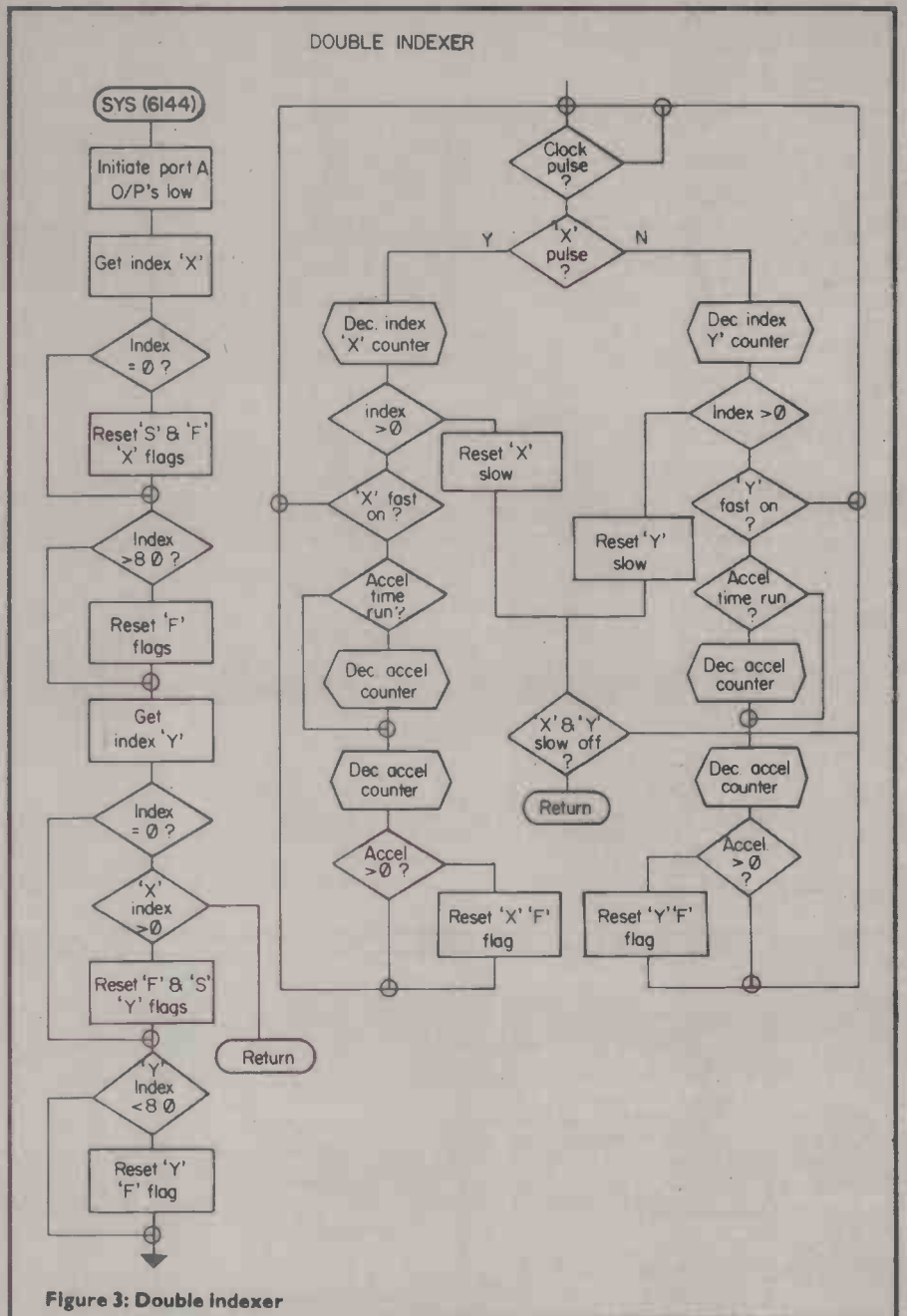

Figure 3: Double Indexer

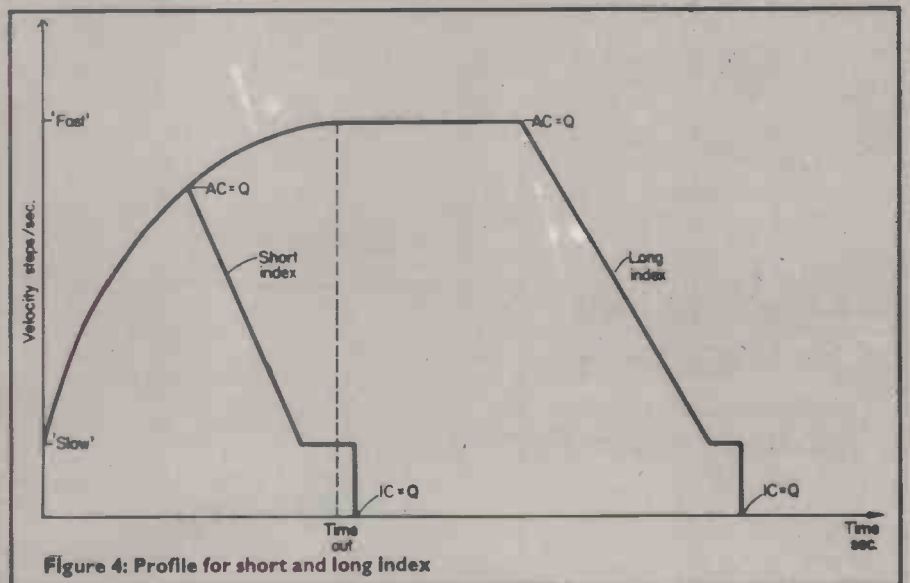
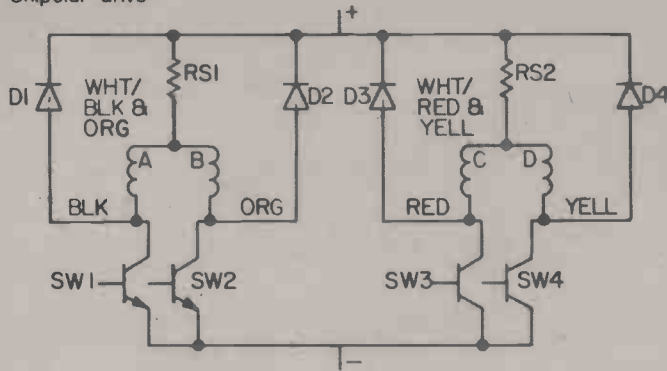

Figure 4: Profile for short and long index

CONNECTION DIAGRAM

Unipolar drive



Full-step

Step	Coil			
	A	B	C	D
1	1	0	0	1
2	1	0	1	0
3	0	1	1	0
4	0	1	0	1
5	1	0	0	1

Half-step

Step	Coil			
	A	B	C	D
1	1	0	0	1
2	1	0	0	0
3	1	0	1	0
4	0	0	1	0
5	0	1	1	0
6	0	1	0	0
7	0	1	0	1
8	0	0	0	1
1	1	0	0	1

Bipolar drive

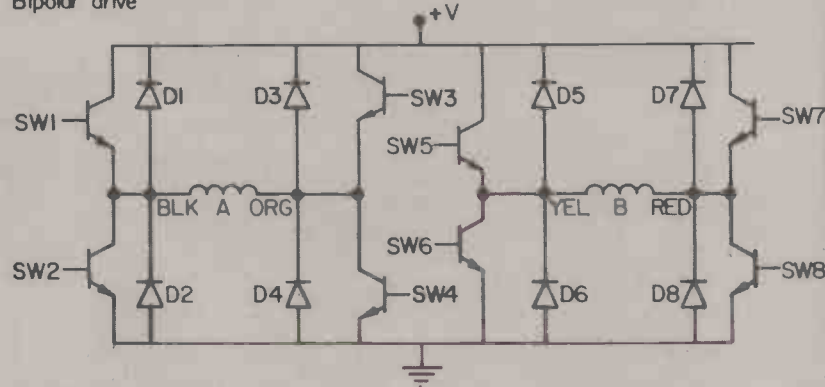

Full-step

Step	Coil	
	A	B
1	1	1
2	+1	-1
3	-1	-1
4	-1	+1
1	+1	+1

Half-step

Step	Coil	
	A	B
1	1	1
2	+1	0
3	+1	-1
4	0	-1
5	-1	-1
6	-1	0
7	-1	+1
8	0	+1
1	+1	+1

Figure 5: Connection diagram

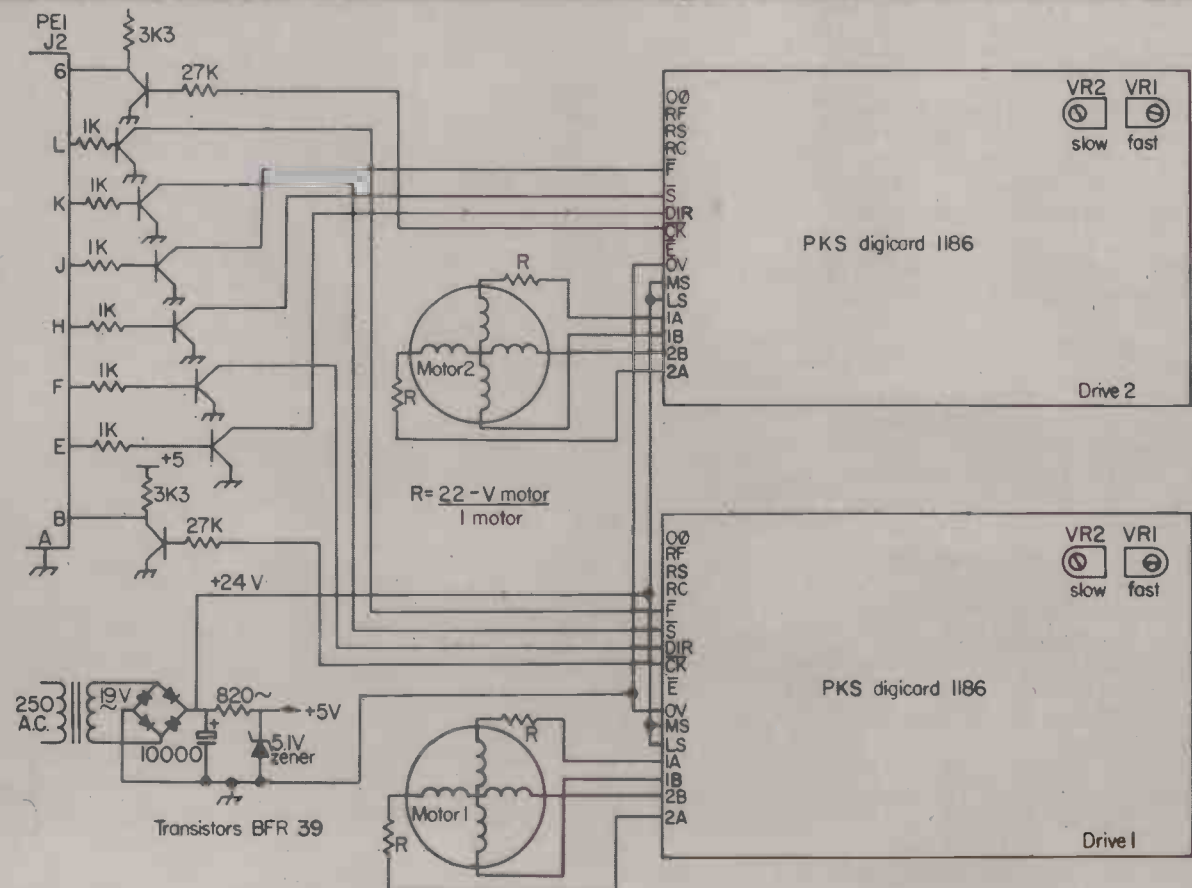

Figure 6

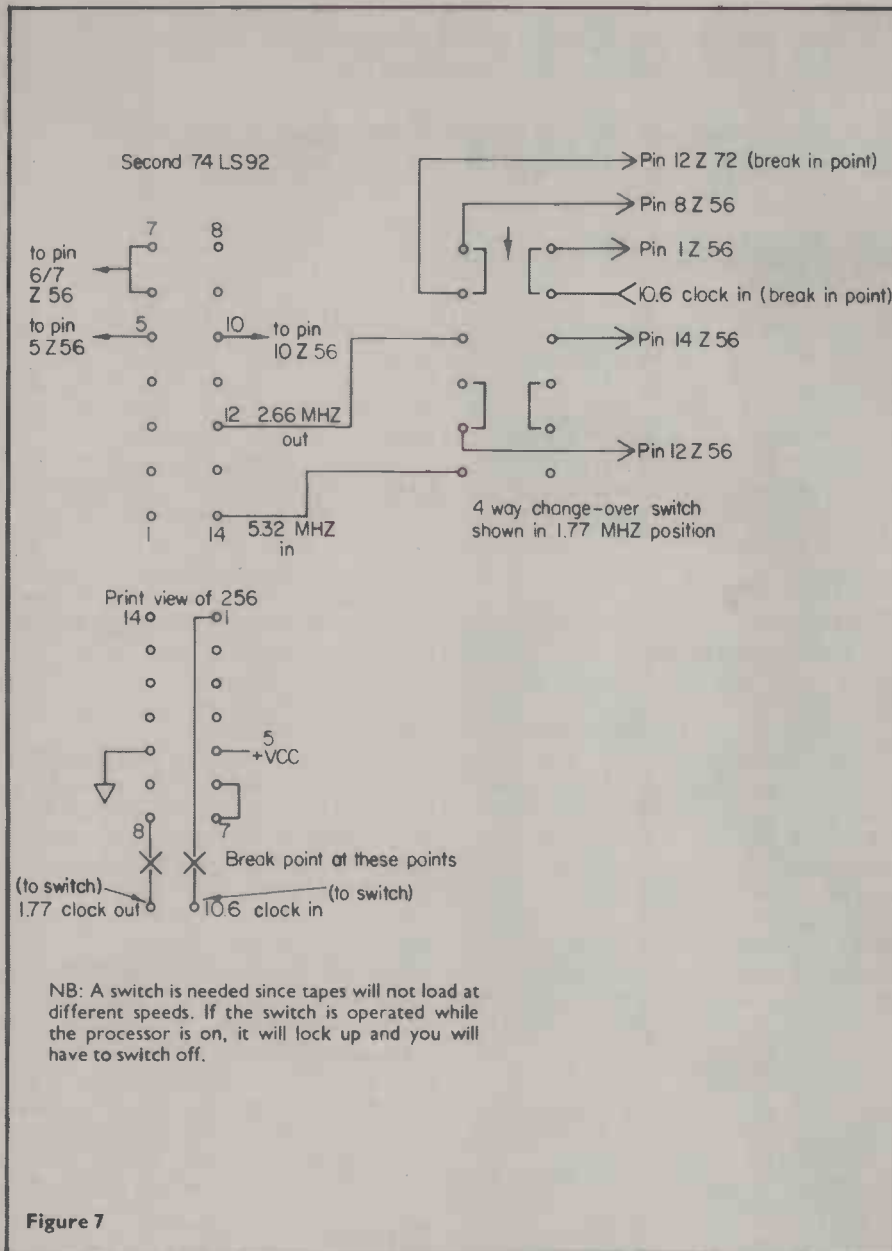

Figure 7

currred, saving all the registers as the Pet operating system does.

The second listing is just a doubling of the first to allow two simultaneous moves. The USR function is difficult to implement for two parameters to be passed so 'mailboxes' are used. Instead a small basic subroutine:—

```
10INPUT"index x":X
20INPUT"INDEX Y":Y
30GOSUB10000
10000AX%=ABS(X):XH%=AX%/256:XL%=AX%AND 255
10010AY%=ABS(Y):YH%=AY%/256:YL%=AY%AND 255
10020IFSGN(X)=-1THEN=SOR8
10030IFSGN(Y)=-1THEN=SOR4
10040POKE84,S:POKE6438,XL%:POKE6439,XH%:POKE 6440,YL%:POKE6441,YH%
10050SYS(6144):RETURN
```

loads locations 6438 — 6441 (\$1926 — \$1929) with the two indexes. Sys(6144) transfers operation to the indexing program. The program transfers these values to zero page and performs the indexing as before. Two flags CA1 and CB1 are now used to detect the pulses generated by the two aces. Sign is provided by 'S' in the

basic program and no negative conversion is necessary.

Due to the length of the double index program, the second cassette buffer cannot be used. Instead the top memory is lowered to 6144(\$1800),POKE134,0, POKE135,24, and the program assembled above here.

Interfacing

The PKS 1186 drive-card logic is all 12 volt cmos. To make the 5 volt port I/O's compatible, simple open collector transistors were used. A 5 volt supply for the CA1,CB1 input pullups is required and derived from the drive card voltage by a 400 MW zener diode.

The complete connection diagram for two drives is shown in figure 5.

A package is being offered that consists of a drive card, a motor and the listings shown here on tape ready to run on a PET. The cost of this is £55 and will give the same performance as shown in this article. The supplier is: PKS Designs Ltd, 40 Nuffield Rd, Poole, Dorset.

TOKEN "Spells for your SORCERER"

EASYGRAF assembler graphics routines for BASIC programs £6

- puts a character at (XY) on screen
- gets a char. from (XY) on screen
- positions the cursor to (XY) ... INSTANTLY ... not by steps
- senses the cursor position (XY)
- gets and displays keyboard chars.
- resides below 100 ... always in memory

EASYCHAR generator for graphic chars.

- lets you draw character using cursor controls this means ...
- NO NEED TO SKETCH ON PAPER FIRST!!!
- you can set any graphics character
- includes EASYGRAF £8
- needs 16K

TOKEN MICRO SYSTEMS,
5 Craufurd Rise, Maidenhead.

• Circle No. 208

CRICKET in BASIC (8K)

Name your own teams to contest 40 over matches.

Features include full scorecard at end of each over; bowling analysis; fall of wickets; extras etc.

Send £9.95 inc. VAT and postage to Q.P. Systems, 5, Beechwood Road, Swansea, SA2 9ZZ.

• Circle No. 209

DISCOUNT PETS

Latest 8K with large keyboard £475, 16K £560, 32K £650, Dual Floppy £680, BASE2 Printer £450, Programmers Toolkits £45, Challenger 1 4K £223, complete with RF converter.

++ TEXAS TI 99/4 £890 ++ with 13" colour monitor

The most advanced home computer, delivery March, order now.

AIM65 4K, cased, powered, Basic £420.

SEAWELL expansion chassis, memories etc.

S-100 16K Fully Static Memory 2MHz assembled and tested £150.

Complete S-100 System with Z-80 CPU, North Star double-density disk, 32K static memory £1200. Also other S-100 products.

Full technical support from MAPCON engineers.

Phone in case prices have fallen. VAT extra.

INTELLIGENT ARTEFACTS

Cambridge Rd, Orwell, Royston, Herts. Tel: Arrington (022 020) 689

• Circle No. 210



APPLE & ITT2020 BUSINESS SOFTWARE

Professionally written packages now available with comprehensive manuals, built-in validity checks, interactive enquiry facilities, user options, satisfying accountancy, Inland Revenue and Customs & Excise requirements. On diskette under DOS 3.2. in Applesoft with SPACE utility. Not adaptations. Written for Apple System. Support all printer interfaces. Sales, Purchases and General Ledgers £295.00 each. Manual only £3. Payroll £375. Manual only £4. General Ledger supports Incomplete Records, Jobs Costing, Branch and Consolidated Accounts etc. General Ledger Applications Manual £10. Prices exclusive of V.A.T. From our shop or your nearest stockist.

COMPUTECH SYSTEMS
168, Finchley Road, London, N.W.3.
Tel: 01-794 0202

• Circle No. 211

APPLE and PET in DUBLIN

- Come and see these fine computers in our new show-rooms.
- Try them and discuss your requirements.

Sensible Software for Apple

- Sales Ledger, Creditors Ledger, Financial Modelling.
- Shape Mapper, Fourier Analysis.
- Educational Systems in Maths, Physics, Geography, Commerce.

S O F T E C H

SOFTECH LTD. 51 Lr Camden St.,
Dublin 2, Ireland
Phone Dublin 784739

• Circle No. 212

MICROPROCESSOR COURSES

- 2 or 3 day intensive courses
- Emphasis on the small businessman
- Hands on use an internal part of all courses
- Course material tailored to individual needs
- Study centres throughout southern England.

For further information and booking form:

MICRO-SYSTEMS U.K.
16 Delta Road
Worcester Park, Surrey
01-337 4356

• Circle No. 213

That old clock keeps turning . . .

by Anthony Butcher

THE CLOCK with moving hands idea rang many bells and we were deluged with programs to do it. Here is the best-documented, though we don't guarantee it will work, since our TRS-80 is having a tantrum and we haven't been able to key-in the program. It is from 14-year-old Anthony Butcher, of Ware, Herts.

Moving hands

The program can be accommodated on a Level-11 machine with 4KB. On first running the program a circular array of numbers (1 to 12) will appear, and shortly afterwards, the clock hands, which begin at one minute past twelve. The hands move on the principal that one is blanked out with RESETs, and then immediately afterwards, another is formed with SETs, but a little further around the face.

This happens first for the minute hand, and then the lower hand, after which a delay of about 27 seconds takes place — to achieve exactly one minute between each cycle — after which the minute hand

The program

```
10 CLS
20 PI = 3.14159: FY = 2.41667: R = 45: X = 64: Y = 58: C = PI
30 PRINT 109, "1": PRINT 310, "2": PRINT 569,
"3": PRINT 758,
"4": PRINT 940, "5": PRINT 991, "6":
35 PRINT 915, "7": PRINT 713, "8": PRINT 518,
"9": PRINT 265, "10",
:PRINT 82, "11": PRINT 31, "12":
40 FOR A = 0 TO 2*PI*STEP PI/(2/3*R)
50 FOR B = 0 TO R
60 RX = INT(X + SIN(A)*R-B): IF ABS(RX-63.5) > 63.5
THEN 76
65 RY = INT(Y/FY-(R-B)*COS(A)/FY): IF ABS(RY-23.5)
> 23.5
THEN 76
70 RESET(RX, RY): RESET(RX-1, RY): REST(RX, RY-L):
RESET(RX+1, RY): RESET(RX, RY+1)
75 RESET(RX+1, RY+1): REST(RX-1, RY+1): RESET
(RX-1, RY-1):
RESET(RX+1, RY-1)
76 NEXT B
78 FOR B = 0 TO R
80 SX = INT(X + SIN(A + PI/(2/3*R)) * (R-B)): IF
ABS(SX-63.5)
> 63.5 THEN 90
82 SY = INT(Y/FY-(R-B)*COS(A + PI/(2/3))/FY):
IF ABS(SY-23.5) > 23.5 THEN 90
85 SET(SX, SY): SET(SX+1, SY)
87 IF B = 0 THEN RESET(SX+1, SY)
90 NEXT B
95 GOSUB 120
100 NEXT A
110 GOTO 40
120 C = C + PI/(16*(R/2))
130 FOR B = R TO R/2 STEP -1
140 RX = INT(X + SIN(C - PI/(16*(R/2)) * (R/2-B))
160 RY = INT(Y/FY-(R/2-B)*COS(C - PI/(16*(R/2)))/FY)
170 RESET(RX, RY): RESET(RX-1, RY)
:RESET(RX, RY; 1):
RESET(RX+1, RY): RESET(RX, RY+1)
172 RESET(RX+1, RY+1): RESET(RX+1, RY-1) _RESET
(RX-1, RY-1):
RESET(RX-1, RY+1)
175 NEXT B
180 FOR B = R TO R/2 STEP -1
190 SX = INT(X + SIN(C) * (R/2-B))
200 SY = INT(Y/FY-(R/2-B)*COS(C) /FY)
210 SET(SX, SY): SET(SX+1, SY)
220 NEXT B
230 FOR D = 1 TO 6700: NEXT DE
240 RETURN
250 END
```

moves again, so the cycle continues. The program obviously leaves room for improvement — for example, so that the clock can be started at any time, obviously making it easier to synchronise.

In line 20 of the program, FY is the scale factor (58/24), X and Y the coordinates for the centre of the clock face, and R the radius. Note that C is a double precision variable because, as it is used to determine the position of the hour hand, very small increments are required — see line 120 — which, due to the graphics resolution, results in a visible movement on the screen only every five or six movements of the minute hand.

Lines 30-35 display a circular clock-face but are not necessary, so can be omitted. Line 40 is the loop for the position of the minute hand, 2/3 being the correct increment to result in it making 60 movements around the face in each cycle; 100 closes the loop and 110 jumps back and begins again after each time round.

The "BP loop (50-76) is used to take all possible radii from O to R and re-set the graphics blocks there (70-75) where that radius intersects with A, hence the "B" in lines 60-65, which determines the coordinate; 78-90 are much the same, except that $PI/(2/3*R)$ is added to A; the line to be set, therefore, always slightly further around the face than the line to be reset.

Circles

The extra statements on lines 60, 65, 80 and 82 are to check for any points going off-screen, which should not happen if $R < 57$, and so can be omitted. The extra "SET"s in lines 85 and 210 are to provide hand of more even thickness all round the screen, due to the shape of the graphics blocks, although they require extra "RESET"s so as not to leave odd blocks left on as the hands go round. The RESET in line 87 is also required due to this, as otherwise the impression of a circle would be left behind by the minute hand.

Lines 120-220 form the hour hand. The principle is much the same as 40-90 and 100, except that smaller increments are used; the hour hand is only half the length of the minute hand (130 and 180) and that the previous position ($\dots -PI/(16*(R/2))$) is re-set and the present one set. Line 230 sets the time delay (about 27 seconds) and 240 returns to line 95, 100 loops back to 40 and so the process continues. Despite line 250, the END can never be reached, the clock having to be stopped with BREAK.



SOFTWARE BUYERS' GUIDE

This month we begin a new, regular feature. We feel there is now enough software for small business systems to be worth a Buyers' Guide. This will be supplemented by regular reviews of particular packages, in the same way that our hardware Buyers' Guide is supplemented by machine reviews.

The material is presented alphabetically by name of supplier. This may not be the most helpful method of indexing, but it is hard to think of a better. If we listed packages by the machines they run on, we would have to have multiple entries, with deleterious effects on pine forests needed for the extra paper; if we list by application, we would have to divide many entries up into half-a-dozen fragments.

The notation 'CP/M' means that the program will run on any machine using the CP/M disc operating system — Rair Black Box, North Star, Research Machines, etc.

The packages listed here cost between £50 and £1000, so we have excluded most of the small programs already available on cassette. In general, a machine will need at least 32K of RAM, discs and printer to use these programs.

Suppliers of relevant software not listed here are welcome to send details to the Editor.

by Mike McDonald

INITIALLY the microcomputer was intended to become another 'home entertainment' product. Early in 1978, the first shipments began to enter the UK and the term computer-store was the 'in word'.

Since then the micro has made a significant impact on the data processing world and also the education industry. The one place it has yet to conquer is the home, the very market it was originally designed for.

It is this shift of emphasis that has brought the microcomputer from its very simple hardware configuration to the present-day small business system look. With this metamorphosis has come the requirement for commercial applications software; it did not really exist a year ago.

Prime functions such as ledger systems, invoicing, stock control and management information have been the targets of recent developments. The tip of the commercial software iceberg is beginning to form.

Beginnings

The micro-processor chip was originally conceived in the early 70s as a process-

control device to replace the traditional electro-mechanical methods.

It was not until 1976 that its potential was seen as a CPU in a larger configuration amounting to a desk-top computer. In 1977, US companies such as Apple Corp, Tandy Corp and Commodore Business Machines put on the market machines specifically aimed at the home user.

The need to keep the price down to a consumer level meant economies in the design and manufacture. Equipment such as the audio cassette recorder as a low-cost storage device was 'pilfered' for use in this new breed of computer.

American systems were not radically altered, apart from the power supply, for sale in the UK. Interest in this country came from three main sources; the electronics hobbyist, Data Processing industry programmers, and education. Alas, the 'home user' was non-existent in the UK, where disposable income is nothing like that enjoyed by the American consumer.

Equipment problems soon became apparent in the form of slow data transfer rates, inconsistent loading and high error rates from the cassette recorders, failure of economy components such as keyboards and

A SUPERCASE FOR YOUR SUPERBOARD!

Precision formed in super quality ABS - supports a TV Complete with all screws & holes for instant fitting Exciting Flame Red (black base) or Ivory (brown base)

COMPUKIT model tool

Instant refund guarantee - or send for leaflet and Superboard software list

MICROCASE

15 Havelock Road Brighton Sussex

£26 plus VAT, post free "TURNS A BOARD INTO A REAL COMPUTER"

• Circle No. 214

Business & Leisure

MicroComputers

16 The Square Kenilworth Warwickshire CV8 1EB Tel (0926) 512127

Visit us for friendly helpful service Demonstrations given. Courses Run Distributors for Nascom & Commodore

New price Nascom 1 kits	£125.00
Nascom 1 Built	£140.00
Nascom 2 Kits	£295.00
Nascom 2 Built	£335.00

Sole distributors for Microtype case for your Nascom 1&2 also veroframes available

Pet 8K	522.50
Pet 16K	641.25
Pet 32K	755.25

Printers disk drives. Pet system dust covers. Full range of books & software C60 cassettes 80p inc. VAT. Printers paper 2000 sheets £13.50

All prices Exclusive of VAT Access & Barclaycard.

• Circle No. 215

SHOP WINDOW



COMMODORE PET SPECIALISTS

We stock the Commodore range of equipment and have a large selection of high quality software to go with it.

We also have programming facilities and fast reliable maintenance support.

In stock is a selection of secondhand and ex. demonstration machines all guaranteed.

Give us a call first to see what we have to offer.

DAVINCI COMPUTERS LTD.
Tel: 01-202 9630
Classic Offices
Rear of Classic Cinema
Hendon Central
London NW4.

• Circle No. 216

TOPMARK Computers

dedicated to

APPLE II



Simply the best!

Full details from Tom Piercy on
Huntingdon (0480) 212563 or circle
enquiry card.

• Circle No. 217

Vets for Pets

Anita Electronic Services (London) Ltd. are specialists in the repair and service of Commodore Pets.

We offer a fast on-site service, or alternatively repairs can be carried-out at our workshops should you wish to bring in your Pet.

Pet maintenance contracts are available at very competitive prices. Trade inquiries welcomed.

For further information tel. or write to:-

John Meade
Anita Electronic Services,
15 Clerkenwell Close, London EC1
01-253 2444

• We also specialise in the repair of all makes of office equipment.

• Circle No. 218

operating system software bugs and glitches.

The original OEMs to enter the market are now introducing their second-generation machines, with improvements in both hardware and software and more peripheral options.

System software (such as the operating system and high-level language) was written, in many cases, by the OEMs concerned, who did not have previous experience in such areas. This led to a wide variety of operating systems and monitors with no proven track record and, in some cases, major errors.

Some manufacturers held their systems on ROM which, had the advantage of protection from user corruption (enabled by the availability of PEEK and POKE commands). The disadvantage of this arrangement lies in the inability to load other versions of operating systems or high level languages unless the user was familiar with machine code routines.

The alternative loading systems software into the core from the tape or disc held the greater disadvantage of being easily corrupted by the user or his programs and also needing extra RAM to hold it.

Until floppy disks became more widely available, this software was often loaded from cassette storage, taking up to 20 minutes, and subject to load errors and data checks. In the same way each manufacturer offered his own version of Basic.

'Plug-in' programs

The revival of this language is indeed a good thing, as Basic is still considered by many to be the easiest language to grasp quickly.

Pascal has received considerable attention — it meets the criteria of small core space and its minimally non-procedural, but it has yet to make any major inroads on offerings from the leading suppliers.

Applications software was virtually non-existent when the personal computer was first made available. Surprisingly, the OEMs had not prepared adequately for this; they did not realize that the home user would require programs to turn his purchase into a useful machine.

Five distinct sources now provide a range of programs that can be 'plugged into' many of the 30-odd systems available today.

1. User groups: The user groups were founded primarily either by the manufacturers for a mass of information concerning internal workings of the machines and problems with them that many of the new owners were experiencing. Early systems were poorly documented and manufacturers had not organised after-sales support for their untried products. Independent groups even set up in competition with the OEM backed user group.

As problems were solved, the groups were able to spend more time on creating and distributing software.

The first programs written by the users included games, utility routines, and statistical and mathematical functions.

There were also the basic programs often used as demonstration modules on small systems and mini-computers which were quickly adapted to the micro and in general became readily available for swapping.

The standard of the software varied from appalling to fair. Very good software needs to be written for the system intended and experience was the missing ingredient.

Games received the greatest time and

attention, firstly because of the limited amount of usable memory. Most systems initially only offered 4 or 8Kbytes of memory. Programs for business applications need not necessarily be large, but often a greater proportion of memory is needed to store information handled by the program as in, for instance, ledger transactions.

The other problem was that computer architecture of this type was very new and programmers had to spend a reasonable amount of time learning the operating systems and determining what was and was not possible with the limited core and I/O facilities of the personal computer.

Writing games software is a good exercise in this respect — the requirements and rules are local knowledge for the programmer and his — or her — attention can be focussed on achieving the required result.

An interesting aspect of the microcomputer is the fact that the small core capacities (a maximum of 65535 bytes can be addressed with the 8-bit processors chosen by most OEMs) has created a new form of programming that is based on a discipline of byte scraping or efficient core utilization.

User groups are now fairly well organised and offer members a reasonable range of games and utility software at cost prices. There is not a great deal of interest in by business user in many of the existing user groups, but as commercial software becomes more widely available and used, it is likely that we will see sub-groups forming or possibly dedicated user groups for the businessman.

2. Distributors: As distributors were appointed by the OEMs, many found the lack of software a distinct disadvantage when selling systems to inexperienced people. Also the potential was seen early for the commercial system based on a personal computer and many sales were made on the premise that peripherals would soon become available, allowing upgrade of the basic hardware.

With the advent of such upgrades, the distributors set about organising software to sell to the user base and also to enhance the product into a total package hardware and software.

Some of them employed programmers as part of an investment in developing commercial applications packages. Others hired the services of software houses to do the design and coding.

The rest either have not entered this market, being content with hardware alone, or have approached the new users offering to act as marketing agents for any original programs written. This method is attractive since little investment capital is required. Much of the commercial software becoming available has been produced this way.

Now that the hardware is capable of commercial processing, the rush is on to produce 'good' packages, for sale to the business community.

3. Consultants and software houses: Neither of these sources are particularly new to this particular market. The micro-computer presents an excellent opportunity for the application of the wealth of experience gained by such organisations in the standard business systems software field.

Not all consultants are experienced or software houses perfect, but the user should expect a reasonably high standard from a company with an accredited name. Experi-



ence in the more traditional mini-computer area is relevant to the new breed of hardware and the user is wise to ask about a particular supplier's background.

Several software houses have been formed specifically to produce programs for the microcomputers and seem to be succeeding. A good example of this is PETSOFT, now called MicroACT, formed by Julian Allason.

Mr Allason started the company specifically to write programs for the Commodore Pet and was then taken over by ACT of Birmingham, a large bureau business with significant experience in the mini/micro scene.

Petsoft remains as a company primarily concerned with games, educational and miscellaneous software and MicroACT concentrates its efforts on the more commercial applications mentioned earlier.

Some firms also offer consultancy with a Turnkey solution which will consist of programming a chosen machine to a user's specific requirements. This is usually costs more but that can't be helped if a package cannot be found to suit the need. In this case the user should look for professionalism as well as experience in a supplier and make sure that the system is fully specified before coding begins. This will ensure that nothing is assumed or left out of a development, and that costs should not vary drastically from the original estimates.

4. Manufacturers: It is unfortunate that manufacturers were later entrants into the software scene. The OEMs have the advantage of the expert knowledge of their hardware and are in a good position to write efficient and sound programs for their equipment. Their main disadvantage is lack of experience in commercial application, although this can be bought-in.

Manufacturers are now beginning to release commercial packages for supply with their systems in an effort to gain a niche in what will become a very lucrative game and also to acquire a 'total product' capability to offer the business person. Some have written their own software and others are using software houses. OEMs have already established user groups to market software to, and to get libraries from.

5. The Press: The media have generally contributed greatly to the software scene. Since the launch of the microcomputer, many home-grown publications have appeared offering sensible articles on programming techniques, file management, and business applications.

When there was not a great deal of software available, they published source listings for games and useful applications, creating a new and novel approach to computing. The result was the breaking-down of the mystique of the computer world and can only be regarded as healthy.

American publications were about the only benefit brought over with the personal computer, and some of these have become relatively technical publications for those interested in systems software techniques.

The media have also acted as a strong voice, by way of hardware reviews, in getting the OEMs to correct faults. Many of today's readers are tomorrow's user's, so bad publicity is bad news for the supplier.

Another novelty on the computing scene are the books of instruction in Basic programs and program listing that are popping

up. These have proved to be highly popular.

Given the multiple supply sources of applications software, the user can begin to concentrate on the best possible configuration needed to meet his requirements. Hardware improvements, combined with dealer experience, will alleviate bug-hunting.

More often than not, the question of capacity will remain the prime question of microcomputer. Other makes of peripheral such as floppy disks and printers, are available for tagging onto proprietary makes of computer, and often offer improved throughput, capacity, efficiency, or reduced cost.

These hardware options should be considered, as they can often double the capacity of the system. The only question must be whether the software package being considered will work with the peripherals.

Software capability

Having determined that capacity is adequate, not just for current needs but also, future expansion, then the next aspect will be the software's capabilities. Many of the packages now available are low in price but fixed in format — they cannot be tailored to the user's requirements.

This is important, as it can cause a company to alter its method of working, which may be adequate, to a system not suited to its particular problem.

An example of this might be the modification of a stock numbering system to a computer-based system that would not indicate particular information previously shown or, worse still, would have less scope for growth and expansion.

Another aspect of computerisation that is often overlooked and yet represents a major cost element is that of data take-on. This is the initial keying and loading of existing information onto the system to allow day-to-day running to begin.

This will not be applicable if the system is phased-in slowly, say in the case of ledgers, against a manual system. From a certain point onwards, all new information is loaded and the files are built up slowly.

The disadvantage lies in the inability to report fully on the true current situation.

The advantage comes in the familiarisation process which allows users to acquaint themselves with the running techniques and check the workings against the manual system until confidence is gained and a full conversion date is chosen.

Packages will vary from source to source in terms of capacity, facilities for data entry and modification and reporting. Only the user will be able to determine exactly what will suit his particular purposes but beware of 'future developments'. If a facility you require is 'currently being developed', ask to see it first before you buy.

All commercial package offerings should have an associated security system. This should take the form of file duplication on a frequent and regular basis with a control form or log sheet (old/current/new), to ensure that files can be recovered against accidental loss caused by human or hardware failures.

The other aspect of security is file protection. Built into the program/s should be a check of file details to prevent processing to occur to the wrong file or diskette. This is particularly important in multiple diskette based systems.

TOWN & COUNTRY PEOPLE

Programmers and would-be programmers

We are looking for people for a new software company which we are setting-up in Milton Keynes.

We still want people for our London-based company.

Good money plus profit-sharing. Lots of mini and micro projects and the chance to play with the latest micro system which we review for *Practical Computing*.

Contact:

Martin Collins
AST Ltd
Staple Inn Buildings North,
High Holborn,
London WC1V 7PZ
01-242-4127 (daytime)
Hemel Hempstead 53549 (evening)

• Circle No. 219

GILBERT COMPUTERS

Gilbert Computers believe in the New **SHARP** MZ

- IMPECCABLY-ENGINEERED
- MODESTLY-PRICED
- BIG-HEARTED, COMPLETE MICROCOMPUTER

It is what we, and you, have been waiting for to solve the problems of the smallest business. You will be able, without specialist knowledge, to quickly and effortlessly handle your stock control; accounting; VAT records; invoicing and other chores.

Provided locally from centres in Market Harborough and Swindon by Gilbert Computers the ONLY suppliers offering these AND

- FREE initial demonstration and explanation at your office, shop or home with no pressure to buy
- Inexpensive tailor-made program service
- Equipment maintenance contracts available
- Finance facilities

Call or write for further details

Old Hall Lane,
Lubenham, Leics. LE16 9TJ 0858-65894

• Circle No. 220

EXIDY SORCERER

32K Micro Computer

£859.00+ VAT

Dealer for

Bristol and South West

ELECTROPRINT (Mr. Tasker)

5 Kingsdown Parade • Bristol 6 • 292375

• Circle No. 221



APPLE II IN SCOTLAND At New Low Prices

Compare new Apple prices and
Benchmark
PERSONAL COMPUTER WORLD
BENCHMARK TESTS

	Apple II	Nascom	RM.	PET
		2	380Z	
BM 1	1.5	1.1	1.4	1.7
BM 2	3.2	5.4	6.5	9.9
BM 3	7.3	11.1	13.2	18.4
BM 4	7.2	11.6	13.9	20.4
BM 5	8.9	12.6	15.0	21.7
BM 6	18.6	19.3	22.3	32.5
BM 7	28.2	27.6	31.6	50.9
BM 8		5.2	6.2	12.3

Apple II plus with 16k RAM £750
16K memory add-on £69

Apple disc drive c/w controller
board £398

Clock card — IMSEC by
388 days £140
Serial card £110

Analog input card 16 channel £170
Super Colour incl. 14 inch
monitor £440

(Allows 3 colour guns to be driven
directly. No modulator. Superb
colour.)

Pascal Language System £296

Hitachi 9 inch monitor £127

Hitachi 12 inch monitor £187

Dolphin BD 80 printer £595
Suitable interface card (Centronics
parallel) £132

Many other items in stock including
word processing packages

STRATHAND
44 ST ANDREWS SQUARE
GLASGOW, G1 5PL

Tel: 041-552 6731 Telex: 777268

CALLERS WELCOME

Telephone orders taken. Access,
Barclaycard and cheque
Hours of opening
9-5 Monday to Saturday



• Circle No. 222

Always try and get 'hands-on' experience of a package before buying it. A good program will be 'bomb proof' — it cannot be interrupted by miskeying, and it should not fall apart or display unintelligible messages as a result of abuse of the keyboard.

Data entry input should be verified by the program for validation of numeric or alpha fields and range checks should be made against numeric quantities such as part numbers, account numbers, transactions etc. The program should not accept invalid entries at the time they are keyed, given the above constraints.

A trait of the personal computer are the RESET, STOP, or INTERRUPT keys on the keyboard. Make certain that depression of this key does not affect a program. It should always be disabled by the software and the only exit from a program that is carrying out file handling should be the one shown in the manual.

Documentation is an equally important subject, especially with off-the shelf programs where no user training is given. It should be clear and concise, indicating all possible system responses to each operation.

If there are difficulties to be encountered, then these should also be covered in the manuals, detailing error messages and probable cause of the failure.

If training is available, then it is recommended the user spends the small amount extra for this. It can often prevent misunderstanding of fundamental issues.

It is also wise to ensure that more than one person in your organisation is capable of operating the equipment. This point is often overlooked.

Some package suppliers offer pre-printed continuous stationery for use with the software. While obviously more expensive than plain stationery, forms will make life easier for the user in the day-to-day running of the system and aesthetically more pleasing.

Support for the software, especially in these early days, is very important, so find out what level of support is available either from the dealer or original authors of the package, and what sort of turnaround can

reasonably be expected. Support can take the form of upgrades to the original programs or an ad-hoc advisory service to cope with the user's difficulties or queries.

It is essential to have a maintenance contract for all the hardware used in the running of prime commercial applications, especially where the hardware comes from several sources. The important thing about the agreement is the response time to a repair call — assuming an on-site repair can be made. As equipment becomes more widely used, perhaps other users can be approached about mutual backup.

Finally, the best possible assessment of any software package can be sought from an installed user. Suppliers should always be capable of supplying a reference user — the more the better — for you to visit. Have doubts if they cannot.

Summary

The market for the low-cost computer with suitable commercial applications is beginning to bloom and will spread to cover all aspects of the business community. Both hardware and software are breaking price barriers in an attack from the bottom upwards on the traditional data-processing industry.

Despite these low prices, software should be no less perfect than its predecessors used on larger machines. To Computerise the prime functions of a business is to computerise its life-blood, and there can be no room for error.

In the coming days of do-it-yourself computing, the user will be responsible for the selection of his system and must make sure that sufficient common sense is exercised in that process to diminish potential problems. Although there are few packages yet, things are moving quickly towards a buyer's market and competition will be keen.

If you are bewildered by the hardware software options and alternatives, then there is always a broad base of professional advice available, for a fee, to head you on the right track.

Let the buyer beware!

ALGOBEL COMPUTERS — payroll

Conforms to I.R. specifications offering the following: calculation of pensions, tax, NI, overtime, holiday, bonus, and additions on a weekly, monthly, fortnight, or four-week basis. Payslip, wages book, coin analysis, and annual tax prints. Capacity — 45 employees on single disk or 445 on dual disk.

Price: £235

APPLE

33 Cornwall
Buildings, New Hall
Street, Birmingham
B3 3QR.

COMMODORE BUSINESS MACHINES — stock control

This is a package for use on the new generation of PET with dual disks and printer. Information held is stock number, reference, description, current level, quantity on order, allocated quantity, cost and sales price, re-order level, total sales year to date, and unit of sale. A general-purpose housekeeping routine is provided to make global changes. Reports on demand cover stock list with highlighting of low/re-order items and totals for value at cost and sale, re-order report, stock-take report producing stock-take dockets for manual use. An interactive extract-and-print search facility is included, with searching on any field or part-field. Capacity is up to 1300 items.

Price: £150

PET

818 Leigh Road,
Slough Industrial
Estate, tel Slough
74111.



COMMODORE BUSINESS MACHINES — business information system

One of a few packages becoming available to allow the user to establish his own management information system without the need to learn a programming language. The user defines to the system the structure of his file and is given general-purpose search, display, and print routines to access his information base. Applications suited to this type of program are personnel records, prospect lists, subscription records, mailing lists, registers, stock files. Two print routines are provided with this package giving a print-label run and a general-purpose report. There is room in the program for user-supplied print formats. Searching is carried out on and off the fields and an index file is created for print purposes. These packages would not be used where calculation of fields is required. Individual records can be quickly accessed and displayed on the screen. Functions include insert, delete, modify, recover and free records.

Price: £150

PET

COMPUTASTORE — payroll

Weekly or monthly system with calculation of standard additions and deductions as well as after-tax adjustment facility. Pre-printed duplicate payslip stationery available. Master file reporting as well as department analysis. Coin analysis is standard and an upgrading service is provided for rate changes.

Price: on application

PET

16 John Dalton Street, Manchester M2 6HG, tel 061-832 4761.

GRAFFCOM SYSTEMS — payroll

This package has been designed to HM Inspectorate of Taxes specification and updates are being incorporated when required. A weekly or monthly system allows payments as cash, cheque or giro transfer. Features include contracted-in NI, cash payroll list, special deductions, pre-event holiday pay calculation, as well as the standard calculations. Reports simple and include employee master file details and payroll log. Capacity — 250 employees.

Price: £500

CP/M

52 Shaftesbury Avenue, London W.1, tel 01-734 8862.

GRAFFCOM SYSTEMS — company purchases system

This is a purchasing control system and records all purchase invoices and carries out purchase accounting (purchase ledger). Features include VAT analysis reports, cost-centre coding, batch totals on input transactions, and interfacing with GSL's general ledger system and name and address system. Capacity: 540-7000 invoices (depending on disks).

Price: £450

CP/M

GRAFFCOM SYSTEMS — company sales system

This is a sales ledgers system that is also compatible with other Graffcom packages, ie nominal ledger and names and address system. Volumes are similar to those shown above. Invoice details may be entered directly against a user chosen reference or account number or from the GSL order entry and invoicing package. Payments, and credits/debits are entered against an invoice number which are referenced to an account number. Facilities are: aged debtor analysis, VAT analysis, cost-centre coding, batch totalling, and reports on keyed entries: payments discrepancies, ledger, aged debtors, and VAT are available.

Price: £450

CP/M

GRAFFCOM SYSTEMS — name and address system

This is basically a mailing system that can be used to hold address information for the accounting packages. Up to six fields are stored for each entry with name, address, telephone, contact, and two user-definable fields. Reporting is left for the user to design and specify depending on requirements ie mail labels, directory lists etc. Capacity varies from 800-5000 entries depending upon the disks used.

Price: £250

CP/M

UNIVERSITY OF SUSSEX
SCHOOL OF BIOLOGICAL
SCIENCES

Experimental Psychology Subject Group ELECTRONICS TECHNICIAN GRADE 6

Applications are invited for the above post which will involve the design and construction of circuits to interface the departmental mini computers (PDP 11's) and microcomputers (M6800's) either to each other, or to I/O devices or other peripherals. A knowledge of digital circuit design is essential. The successful candidate will possess a sufficient knowledge of both hardware and software to carry through experimental ideas from inception to execution, to design and construct new equipment and apparatus in consultation with faculty and students, and to advise faculty on the use of new technology. The post offers an exciting opportunity to work in collaboration with faculty in the practical implementation of current computer technology.

Minimum qualifications HNC or equivalent. Minimum of 7 years relevant experience.

Salary within range £4243 — £5068 p.a. (under review)

ELECTRONICS TECHNICIAN GRADE 3 OR 5

Required in the Group's Electronics Workshop. Duties will involve construction and/or development of specialised electronic equipment for research and teaching purposes, e.g. the construction of interfaces for Departmental PDP 11 computers and M6800 microcomputers. Candidates should possess a good working knowledge of modern digital electronic design and construction.

Appointment to the appropriate grade will depend on the number of years relevant experience and qualifications.

Grade 5 — Salary range £3700 — £4320 p.a. (under review). Minimum experience normally seven years with ONC/City & Guilds or equivalent.

Grade 3 — Salary range £3122 — £3533 p.a. (under review). Minimum experience three years with ONC/City & Guilds or equivalent.

Both posts carry an entitlement of twenty days annual holiday plus Bank Holidays and University Closures.

Applications in writing, as soon as possible, to the Laboratory Superintendent, School of Biological Sciences, University of Sussex, Falmer, Brighton, Sussex BN1 9QT. Both posts open to men and women.

• Circle No. 223

NASCOMS 1 & 2

Up to 10 Channels I/O Board.
Other I/O Boards soon.
S.A.E. to:

BING SYSTEMS

8 Glen Road, Bingley,
West Yorks., BD16 3ET.

• Circle No. 224



Nelson Computer Services Ltd

BUY-SELL-LEASE-RENT-MAINTAIN



MEDIA

- MINI DISCS
- FLOPPY DISCS
- DISC CARTRIDGES
- DISC PACKS
- MAGNETIC TAPE
- PAPER TAPE
- TELEPRINTER ROLLS
- PRINTER RIBBONS



EQUIPMENT

- PRINTER TERMINALS
- TELETYPES
- IBM CARD PUNCHES
- UNIVAC CARD PUNCHES
- DISC & DATA STORAGE
- FIRE SAFES
- HAND PUNCHES
- BURSTERS
- DECOLLATORS
- SHREDDERS
- GUILLOTINES
- VDU DESKS
- DATA BINDERS



TEL: 07062-29125

ST. JOHN'S COURT, BACUP ROAD,
RAWNSTALL, LANCS BB4 7PA

• Circle No. 225

**GREAT PROGRAMS
FOR YOUR PET**

- 5 CARD STUD POKER £8 inc
 - TARGET GOLF £8 inc
 - AIR TRAFFIC CNTRL £5 inc
 - DOGS CHANCE £5 inc
 - TENPIN BOWLING £5 inc
- All on good quality cass.

★ SPECIAL OFFER ★

The above five programs
on one CBM Disk: £21 inc

LANDSLER SOFTWARE

29a Tolworth Park Road
Surbiton Surrey KT67RL

• Circle No. 226

FOR SALE

TELETYPE 43 (keyboard with Bi-directional Interface used with PET.
Cost over £1,200.00 Perfect Condition Seen Working.
Best offer over £800.00. Contact:
PHILIP H CARLOW TEL: 01-346 9677.

• Circle No. 227

**GRAFFCOM SYSTEMS —
stock control system**

CP/M

This stock reporting system allows details to be entered against each stock item showing: description, product code, unit, unit price, quantity on hand/on order/minimum. Stock movement reports may be produced for any period, with a comparison with those for the previous period. Features include on-line display of current situation for any one item, detailed reports of stock movements and analysis, and interfacing with GSL's order entry and invoicing system. Capacity is in the range of 520 items up to 6000 items, subject to storage.

Price: £350

**GRAFFCOM SYSTEMS —
order entry and invoicing**

CP/M

This package maintains order details and invoicing until completion of the transaction. Invoices are generated for part orders and part quantities within item, subject to stock availability. Sales analysis reports show movements by product code, or classification within any period. This package interfaces with the name and address system, the stock control system and the sales accounting packages. Functions are: add new orders, update orders, remove orders, produce invoices, sales analysis, and security back-up routine. Capacity ranges from 500 to 5000 active orders, subject to mass storage system.

Price: £350

**GRAFFCOM SYSTEMS —
lease rental and hire-purchase
system**

CP/M

This is an unusual package to control agreements and contracts that are payable at regular intervals at fixed amounts. The program handles four kinds of agreement — lease, rental, hire purchase and maintenance, with payments by invoice, standing order or cash. This package interfaces with the GSL sales system and name and address system. The system can calculate all payment types over any period and post these directly to the sales ledger system, for the appropriate period. Features include: cost-centre coding, various payment periods, on-line display of current agreement details. Reports are: agreement report, payment invoices, mailing labels, cash payments worklist, bank reconciliation list, and a sales ledger list if used with the company sales package.

Price: on application

**GRAFFCOM SYSTEMS —
time recording system**

CP/M

This is designed for service companies where the commodity is man-time. Information is gathered from employee time sheets and bills entered into the system. Billings can then be produced showing weekly costings and expenditures. Analysis can be weekly, fortnightly, monthly for account and sub-account codes and activities. Up to 100 activity codes may be assigned with a unique rate. This package can be interfaced with the sales accounting system for invoicing and also to the order entry system.

Price: on application

**GREAT NORTHERN
COMPUTER SERVICES —
general ledger**

Z80/8080

This is a double-entry booking system originally written by Serendipity Systems Inc (USA) and converted for UK use by the GNCS. Features include user-defined chart of accounts, month-end and year-end totals routines, data validation, and reports include: daily summary journals, monthly receipts, cash disbursements, and sales journal, chart of accounts, operating statement by user/department, and balance sheet and historical activity reports by account code or job number. Capacities will depend on hardware used.

Price: £275

GREAT NORTHERN COMPUTER — retailer stock control

This is a simple stock-control routine aimed at the retail user where movements are high and reporting is more detailed. Stock items are coded to user requirements with an alphanumeric code. Information is held on description, price, cost, minimum level, current level etc, with an update routine. Reports are produced for stock items — on hand, on order and on file, items at or below re-order level, week-to-date sales, month-to-date sales, three-month sales analysis, and year-to-date totals. There is also a user-specified report generator for special requirements.

Price: £275

Z80/8080

15 Wellington Street, Leeds LS1 4DL, tel 0532 450667.

GREAT NORTHERN COMPUTER — client billing

This is a man cost control system for service-type industries. The user can define client numbers, service codes and case numbers. Features include: auto-calc of activity by service code, auto-billing of fixed monthly charges, auto-account ageing. Reports are produced for clients list with ageing and last-payment details, master list of service codes and activities, list of current transactions both released and held, by clients and case numbers, and client statements and billing statements.

Price: £330

Z80/8080

GREAT NORTHERN COMPUTER — job order control

This package is suited for the one-off job environment and offers: user-defined customer and order numbers, order detail information and status entry, update of current records, partial shipment entry, and full data input validation. Reports include individual order details, lists of open orders and status, by customer type, overdue, and dates, and invoices with mailing labels for completed orders.

Price: £275

Z80/8080

GREAT NORTHERN COMPUTER — appointments system

This software package is aimed at the medical world and comes in the form of an individual system or group practice system. The program maintains records of appointments for each of several practitioners over 15-minute intervals. The group system holds details on appointments for groups (up to eight per 15-minute interval). There are user-defined practitioner schedules and reserved times and days. Data is entered interactively and look-up is available by time or by patient/client name with truncation/masking. Schedules can easily be modified and search is provided for free periods, by time of day. Reports are produced by individual practitioner by day and time utilization by practitioner by month. Load units can be pre-determined for the group system and load units assigned to a 15-minute interval.

Prices: £220, individual system, £275 for group system.

Z80/8080

GREAT NORTHERN COMPUTER — integrated business system

This is a consolidation of the Serendipity covering: general ledger, payroll, accounts payable, and accounts receivable system. The latter three programs produce a file containing debit or credit amounts with GL account numbers, transaction date, user-assigned reference number and appropriate employee/customer/vendor number. Whenever the daily entry program of the General Ledger is run, the file can be read in the reset. Facilities and features are those already stated for the other systems.

Price: £995

Z80/8080



STOP PRESS: Superboard Compatible!

COLOUR YOUR NASCOM!

DAZZLING COLOUR GRAPHICS FOR NASCOM 1

Genuine bit-addressable "pixel" system for straightforward programming of pictorial or mathematical functions.

8 Colour display plus 8 colour independent background facility. Full documentation with **FREE SOFTWARE**: powerful sub-routines for vector generation, demonstration program for animated effects. All runs in Nascom 1 without expansion. Complete with UHF Colour Modulator for operation with normal colour TV set. Superior design allows connection to most other micro-processor systems — send us diagrams etc of your b & w video circuitry for free advice. Don't be fooled by the price: this is a top quality product which will transform your computer.

NOW AVAILABLE FOR LIMITED PERIOD AT £45 Inclusive of VAT and postage

WILLIAM STUART SYSTEMS LTD Dower House, Bittercay Road, Herongate, Brentwood, Essex CM13 3SD. Telephone: Brentwood (0277) 810244

• Circle No. 228

ITT Apple 2020 (Palsoft + Colour)

BASIC SYSTEM from £867.00
BUSINESS SYSTEM from £2,400.00
 also
 a range of printers & VDU's including **DIABLO DAISYWHEEL** printers from £1740.00

Larger Business systems also available.
 Sales — Service — Supplies

BRINDIWELL LTD
Frampton Cotterell
BRISTOL
Tel: Winterbourne (0454) 774564

• Circle No. 229

Modata 30 ST. JOHNS ROAD TUNBRIDGE WELLS KENT
 Telephone: Tunbridge Wells (0892) 41555

DIGITAL MICROSYSTEMS
 LOW COST BUSINESS COMPUTERS

DSC-2 ONE to 29 MEGABYTES DISK STORAGE
 64 Kbytes of Main Memory — STANDARD
 Digital Research CP/M operating system — STANDARD
 TEXT PROCESSING, BASIC, COBOL, FORTRAN available

HEX-29 32 to 96 MEGABYTES DISK STORAGE
 32 USER & 16 TASK capability — STANDARD
 Reentrant ASSEMBLER & BASIC — STANDARD
 Floppy disk based development system available

MODATA still need DEALERS in parts of U.K. and IRELAND

• Circle No. 230



COMPUCOLOR II
 PAY FOR MOD.3 — MOD.4
 PAY FOR MOD.4 — GET MOD.5

PET
 UP TO £100 FREE SOFTWARE
 WITH NEW PET.
 4K TO 8K CONVERSION £79*
 8K TO 32K (from) £210*

APPLE
 AT LEAST £75 FREE SOFTWARE
 WITH NEW APPLE

TEXAS
 T199/4 COLOUR, MUSIC & GRAPHICS.
 P.O.A.

SHARP
 UP TO £75 FREE SOFTWARE WITH NEW
 MZ-80K

PETSOFT: GEMSOFT: LANDSLER
 PROGRAMS 'TAX FREE'

TELETEXT CONVERTOR
 WITH REMOTE, ONLY £199.95*

Most makes sold/bought/constructed.
 Many used bargains in stock
 * Plus VAT & Carriage

OPTELCO
 RAYLEIGH (0268) 774089 (to 8 pm)

• Circle No. 231

TRS-80 System

All items stocked, Barclaycard, Access & American Express are welcome, or apply for your own RADIO SHACK Charge Card. U.K. Delivery by Securicor. Direct and Personal Exports.

RADIO SHACK LTD.
 188 Broadhurst Gardens,
 London NW6 3AY.

Tel: 01-624 7174 Telex 23718

• Circle No. 232

MINE OF INFORMATION LTD

1 FRANCIS AVENUE,
 ST ALBANS AL3 6BL
 ENGLAND

Phone: 0727 52801
 Telex: 925 859

MICROCOMPUTER CONSULTANCY & BOOK SELLERS

• Circle No. 233

MICRO PEOPLE

Greenwood Associates (the D P Staff Consultants) are pleased to announce the formation of Micro Computers Staff Division.

If you are looking for a job in Microcomputing or have a requirement for staff contact Colin on 01-902 9044.

GREENWOOD ASSOCIATES

112-114 WEMBLEY PARK DRIVE,
 WEMBLEY, MIDDLESEX, HA9 8HG

• Circle No. 234

GREAT NORTHERN COMPUTER — accounts payable

Z80/8080

This ledger package offers the following features: user-defined payee numbers, interactive data entry and edit functions, automatic calculation of discounts, adjustments entry for retired goods, user-defined age categories, bill review program, statements and check listings, and a master payee list with aged balances and audit list of cheques paid.
 Price: £275

GREAT NORTHERN COMPUTER — accounts receivable

Z80/8080

This sales ledger again is sourced from Serendipity and has: user-defined customer numbers and service codes, user-defined default fees, calculation of activity by service code, finance charging, account ageing, ability to change past-due balances. Reports on master customer list, lists of service codes and activity on a daily, monthly, or yearly basis and, of course, statements.
 Price: £275

G.W. COMPUTERS — general

PET

Z80/CPM
 6800

A suite of 24 programs covering most business applications including: stock, invoicing, sales ledger, purchase ledger, incomplete records accounting, tax analysis, payroll and management information from the above. Each program covers either an entry, display or print against capacities of four companies, four bank accounts, 50 agents, 999 customers/suppliers, 1000 stock items, 200 employees; subject to disks.

Prices: Versions 1, 2, 3, & 4 increasing in complexity, £275 — £575

89 Bedford Court
 Mansion, Bedford
 Avenue, London
 W.C.1, tel 01-636
 8210.

PROFCOMP — incomplete records accounting

NORTH STAR

The package is aimed at practising accountants and is based on a single-client-per-diskette system, allowing each client to have a chart of accounts and individual formatting. The program allows for eight journal types and one adjustments journal. Reports are parameter-driven by the user and include a general ledger print; by account type, final accounts print and balance sheet. A maximum of 2000 journal entries can be processed in any one pass of the accounts update. A provisional entry routine allows the user to display the effects of the journals on the accounts before they are committed.
 Price: on application

107 George Lane,
 South Woodford,
 London E.18.

MICROACT (PETACT) — purchase ledger

PET

Very similar to the sales ledger in design and use. A suite of programs provided on a floppy disk with manuals allows the user to update supplier name and address file containing discount rate and payment method (cheque or giro), post transactions to the files, print remittance advice notes, ledger records and account balances, print a creditors list, and carry out month-end summarisation of accounts and clear down of the transactions file. Aged balances, over four months, are displayed for each account accessed. Built-in security system allows simple diskette duplication. All programs are accessed from a menu. Capacities as per sales ledger.
 Price: £350

Radcliffe House,
 66 Hagley Road,
 Edgbaston,
 Birmingham B16
 8PF.

MICRODIGITAL — mailing

APPLE

Another Apple-sourced package **Apple Post** is a data base system for the production of mailing lists. Entry and listing of up to 2500 names, address, phone number with masked searching of name field. Label runs can be keyed on name or Zip-code search.
 Price: on application

25 Brunswick
 Street, Liverpool
 L2 0PJ, tel 051-236
 0767.

MICROACT (PETACT) — sales ledger

This package was written for the PET using both the CBM drive and Computhink drive. Entry of invoices, credits, cash and transfers is through an account display routine giving full account details and updated totals. Reports include audit list, aged debtors list, control accounts, and statements. Account enquiry is simple with a print option. Account details can be spread over multiple diskettes in sections. Capacities: 200 accounts per section (diskette) with 700 transactions on the PET disk drive, or up to 2000 accounts and 7000 transactions on the Computhink drive.

Price: £350

PET

MICRODIGITAL — ledgers

The **Controller** is a suite of three programs sourced from Apple Corporation comprising general/sales/purchase ledger programs. Each package can have up to 250 accounts with up to 1000 transactions per account. Facilities include summaries of journal accounts, revenue/expenses, balance sheets, income statements, mailing label print, customer/supplier lists, sales commission reports and statement printing (48k min).

Price: on application

APPLE

STAGE ONE COMPUTERS — Petaid reporting system

Fairly similar in function to the Commodore offering, and again has a very wide application for information retrieval both for look-ups and print runs. This package allows the user to set up his file layout on the screen in a physical format and offers string searching within records and logical testing of matching results. Functions include insert, delete, browse, display, screen formatting, and create.

Price: £120

PET

6 Criterion Avenue, Old Christchurch Road, Bournemouth.

STRUCTURED SYSTEMS GROUP — mailing

NAD is offered by a number of dealers on different machines, therefore capacities will vary. The master file can contain a number of user-defined fields such as other contact names, comments etc, and each field can be searched using masking techniques. A file extract facility is available so that secondary files may be created from an extract run. Label runs allow for 1-4 across label printing.

Price: around £50

CP/M

LP Enterprises, 8 Cambridge House, Cambridge Road, Barking IG11 8NT, tel 01-591 6511 and A J Harding, 28 Collington Avenue, Bexhill-on-Sea, Sussex, tel 0424 220391 and other dealers.

STRUCTURED SYSTEMS GROUP — nominal ledger

General ledger system with user-definable reporting system. Standard reports include ledger print, balance sheet, income statement, chart of accounts, accounts distribution, and change in financial position. Full audit trail facility with an automatic back-up system. Statement format can be varied by the user. Batch entry is permitted for ease of data prep and trial balance is standard. Capacity will vary with hardware.

Price: £500

CP/M

STRUCTURED SYSTEMS GROUP — purchase ledger

This package is also compatible with the nominal ledger system and can transmit data across to the NL. Data entry is pre-formatted to a SSG pay-voucher system. The package can compute discounts, schedule payables by vendor or date, summarise expense activity, and print checks. A release program allows user-defined pay dates and amounts to be entered with analysis reports on aged balances and cash requirements. A check register is held for audit purposes. DMS provides formatted data entry routines on the VDU with full data validation.

Price: £460

CP/M



UPERSOFT
STILL SMALL ENOUGH TO CARE!

Our new **FREE** catalogue lists 38 PET programs from £1-£12. Many of our 17 utility programs are only available from us, and as for games, **AIR ATTACK** at £3 includes a free overlay which brings colour to your screen! Blank **RACAL** cassettes are £4.50 for ten C.12's.
SUPERSOFT 28 Burwood Avenue, Pinner, Middx.

STOP PRESS
BUSINESS PROGRAMS TO ORDER —
PET AND TRS80

• Circle No. 235

CUMBRIA & the N.W.

Our considerable experience in all aspects of running small/medium businesses gives us a rare capability to assist first-time computer users in language we can both understand. We supply 'Pet' Hardware and custom-written or 'standard' business programs.
For (free) application advice, contact:

MICROPUTERS Ltd
BERWICK FOLD HOUSE,
CROOK, KENDAL, CUMBRIA.
Tel: Windermere (09662) 4104

• Circle No. 236

PREELANCE & PERMANENT PROGRAMMERS AMS GROUP

Established Commodore Business systems dealers are organising a network of skilled PET programmers with commercial computing experience to assist purchasers with system development and implementation.

Tel 01-638 9319
AMS, 8 Moorfields
London EC2 9AA.

• Circle No. 237

LB ELECTRONICS

WE HAVE MOVED TO —
11 Hercies, Hillingdon, Middx.
(Just off the A40).

We stock RAMs, EPROMs, Keyboards; Disc Drives and one-off computer peripherals. We stock Pet 8K and many everyday components and surplus equipment TTL, CMOS, LINEAR, LEDS, Cannon D type, plugs/sockets etc, etc.
Also, software programs for PET and SORCERER at discount prices. Lists — SAE please.

We are open Monday, Thursday, Friday, Saturday 9.30-6. Tel. Uxbridge 55399.
Sorry but no catalogue yet. We keep *Practical Computing* magazine.

• Circle No. 238



Problems with your Micro?

Let us help. We have wide experience of the problems and pitfalls that can arise when a computer system is installed.

- Programs designed or written
- Help given in organising a computer system for best results and easiest use
- Independent advice in choosing hardware

Mc Millan Computing Services
3 Tithebarn Grove,
Calcot, Reading.
Tel: 0734 414751 (Ansaphone service)

• Circle No. 239

If you . . .

are thinking of using a microcomputer, or want to get more out of your system

Contact us for . . .

Programming & Systems design
Feasibility studies
(Independent) advice on machines/software

JAM Consultants
99/101 St Leonard's Road
Mercantile House
WINDSOR, Berks.

tel : Windsor 57340/9

• Circle No. 240

MICRO ADS

are accepted from private readers only, pre-paid and in writing, 20p per word, minimum charge £2.

TRS 80 16K LEVEL II mint, six month's old, including library 100 (100 programs). Also editor assembler. £485. 01-450 5049. Evenings.

PET Professional 2001-32N with cassette. Large keyboard, green screen. Used only ten hours. Tapes included. £775. EPSOM 23552.

Apple II, 32K applesoft card, r.f. modulator. NTSC/PAL switch, 3 months old, little used, perfect, unsuitable for requirement. £950 inc. VAT. Tel: 09627 9228, will delivery, London, Southampton, etc.

UK101 runs superbly, 8k RAM, cased. With star trek, graphics games, two disassemblers, plot routines, hex loader etc. etc. Offers around kit price 01-997 9437.

PET SOFTWARE. All Petsoft programs available at large discounts off list price, also Petact disc based business programs at low prices plus full range of pet accessories E.Gr Green Screen at £8.00. Contact 0742-699374 or Telex 547700 for details.

Z-PLUS Micromputer 64K/1MByte with Elbit DS1920-X terminal and IP125 Printer £3500. Tektronix Oscilloscope £100. Tel 543-1398. nascom 1 £150.

Minimal NASCOM games cassette: Lander, Minefield, Zombie, Dominoes, Minotaur, Submarine. Only £6 including documentation. M. J. Evis, 23 Quantock Road, Bridgwater, Somerset.

South West Technical 6800 system. 32K with serial and parallel interfaces, twin minifloppys, VDU, Centronics 779 printer, prom programmer and all software. Hardly used. Half price for quick sale £1500. D. G. Elliman Ferndown 891659.

STRUCTURED SYSTEMS GROUP — sales ledger

CP/M

An open-item package again offering customised statements. Reports include: aged trial balances, statements, reminder letters, sales reports, and transaction journals. Ageing is over 30, 60 or 90 days and processing can be carried out on a cyclic basis over 26 days to separate base by billing date location, status or size. Fully compatible with the nominal ledger.

Price: £400

TRIDATA MICROS — sales ledger

TANDY TRS 80

Written specifically for the UK, this ledger offers: update of customer file, transaction entry and update, display or list invoices and credit notes. Reports include statements, aged debtors control list, VAT analysis, sales day-book, cash day-book, customer names and addresses, labels, debtors list. Cash input and allocation is permitted and VAT rate change is possible. Capacity unknown, but 32K min with two disk drives required.

Price: £100—£225

Smithfield House,
Digbeth,
Birmingham, tel
021-622 6085.

TRIDATA MICROS — purchase ledger

TANDY TRS 80

Similar in design to the sales ledger, this package offers: supplier file create/update, hold/release payment, creditor control report, creditor list, remittance advice printing, cheque list, VAT analysis report, purchases day-book listing, suppliers name and address label and print list, and alteration of VAT rates.

Price: £100-£175

TRIDATA MICROS — nominal ledger

TANDY TRS 80

Functions available — nominal postings and updates, trial balance, profit-and-loss account, options, and file maintenance. It is not known if this package integrates with the sales and purchase systems.

Price: £175

TRIDATA MICROS — stock control

TANDY TRS 80

A simple stock package containing details of stock items, levels, and adjustments. Facilities available for updating master stock file, stock issues and receipts and minimum re-order levels. Other information held are prices and references. Reports are produced for stock movements, re-order situations, stock list, etc.

Price: £150

TRIDATA MICROS — payroll

TANDY TRS 80

The payroll program allows for creation of new employee records and deletion, amend employee record, amend parameter file (calculation rules), amend totals file, display of spare numbers file, calculation and print of payslips, coin analysis, print totals, year-end summary, and amendments to the package.

Price: £200

TRIDATA MICROS — order entry/invoicing

TANDY TRS 80

This package ties into the stock control offering and the sales ledger system to give order-entry functions and control with amendment and enquiry facilities. Reports produce invoices and order information.

Price: £225

A stand-alone invoicing program is also available to be used in conjunction with the stock and sales ledger systems to print invoices and at the same time reduce stocks and update the sales ledger.

Price: £75

COMPUTERMANIA

PRESENT

COMPUCOLOR II

Includes integral **floppy disc**
and full **colour display**

**sensational
offer**

£895

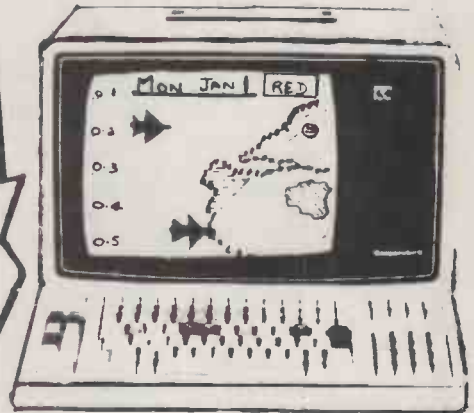

- * 13" COLOUR MONITOR for COLOUR GRAPHICS etc
- * Built in MINIFLOPPY DRIVE 51.2K per side
- * Impressive EXTENDED BASIC on 16K ROM
- * HIGH RESOLUTION GRAPHICS 128x128
- * RS232C port simplifies PRINTER or MODEM atch.

prices excl. VAT

8K user RAM	£895.00
16K user RAM	£998.00
32K user RAM	£1100.00
PRINTER 912S	£395.00

Computermania (08446) 729 102 WALTON ST OXFORD

Fantastic FREE OFFER!! worth £11!

With all purchases from COMPUTERMANIA

nascom-1
IN STOCK! £140

nascom-2
IN STOCK! £295

THE BASIC HANDBOOK

ENCYCLOPEDIA of the BASIC
by Dr. David A. Lien



ITT 2020

: TV output :	16 K	£ 815
: Loudspeaker :	32 K	£ 870
: Cassette interface :	48 K	£ 910

8K ROM Basic . 8K RAM . IBM type keyboard
Onboard Cassette, TV, Video interfaces
This must be the most powerful and
flexible development kit to hit the
European market
Phone for Computermania's mad offer!

PRINTER IMP

- Serial RS232 interface
- 80 characters wide
- Bidirectional printing
- 60 lines per minute
- 10 line print buffer
- 96 character ASCII set
(includes upper/lower case, \$ # £)
- Automatic CR/LF
- 8½" paper
- Optional tractor feed
- Baud rate from 110 to 9600
- External signal for optional
synchronisation of baud rate

ONLY

£ 325

Computermania

• Circle No. 250

Shopping List

Super software from the world's leading microsoftware supplier.

	Software with Manual	Manual Alone		Software with Manual	Manual Alone
DIGITAL RESEARCH					
CP/M* FDOS — Diskette Operating System complete with Text Editor, Assembler, Debugger, File Manager and system utilities. Available for wide variety of disk system including North Star, Helios II, Micropolis, ICOM (all systems) and Altair. Supports computers such as Sorcerer, Horizon, Cromemco, Ohio Scientific, RAIR Black Box, Research Machines, Dynabyte, etc.					£75/£15
CP/M version 2 (not all formats available immediately)					£95/£15
MP/M					£195/£25
MAC — 8080 Macro Assembler. Full Intel macro definitions. Pseudo Ops include RPC, IRP, REPT, TITLE, PAGE, and MACLIB. Z-80 library included. Produces Intel absolute hex output plus symbols file for use by SID (see below)					£55/£10
SID — 8080 symbolic debugger. Full trace, pass count and break-point program testing system with back-trace and histogram utilities. When used with MAC, provides full symbolic display of memory labels and equated values					£45/£10
ZSID Includes Z80 mnem	NEW	quires Z80 CPU			£50/£10
TEX — Text formatter to create paginated, page-numbered and justified copy from source text files, directable to disk or printer					£45/£10
DESPOOL — Program to permit simultaneous printing of data from disk while user executes another program from the console					£30/£1
MICROSOFT					
BASIC-80 — Disk Extended BASIC Interpreter Version 5, ANSI compatible with long variable names, WHILE/WEND, chaining, variable length file records					£155/£15
BASIC Compiler — Language compatible with Version 5 Microsoft interpreter and 3-10 times faster execution. Produces standard Microsoft relocatable binary output. Includes Macro-80. Also linkable to FORTRAN-80 or COBOL-80 code modules					£195/£15
FORTRAN-80 — ANSI '66 (except for COMPLEX) plus many extensions. Includes relocatable object compiler, linking loader, library with manager. Also includes MACRO-80 (see below)					£205/£15
COBOL-80 — ANSI '74 Relocatable object output. Format same as FORTRAN-80 and MACRO-80 modules. Complete ISAM. Interactive ACCEPT DISPLAY, COPY, EXTEND					£325/£15
MACRO-80 — 8080/Z80 Macro Assembler. Intel and Zilog mnemonics supported. Relocatable linkable output. Loader, Library Manager and Cross Reference List utilities included					£75/£10
XMACRO-86 — 8086 cross assembler. All Macro and utility features of MACRO-80 preserved. Mnemonics slightly modified from Intel ASM86. Comp. utility data sheet available					£155/£15
EDIT-80 — Very fast random access text editor for text with or without line numbers. Global and intra-line commands supported. File compare utility included					£45/£10
EIDOS SYSTEMS					
KISS — Keyed Index Sequential Search. Offers complete Multi-Keyed Index Sequential and Direct Access file management. Includes built-in utility functions for 16 or 32 bit arithmetic, string/integer conversion and string compare. Delivered as a relocatable linkable module in Microsoft format for use with FORTRAN-80 or COBOL-80 etc					£190/£15
KBASIC — Microsoft Disk Extended BASIC with all KISS facilities, integrated by implementation of nine additional commands in language. Package includes KISS REL as described above, and a sample mail list program					£295/£25
					£215/£25
MICROPRO					
Super-Sort 1 — Sort, merge, extract utility as absolute executable program or linkable module in Microsoft format. Sorts fixed or variable records with: data in binary, BCD, Packed Decimal, EBCDIC, ASCII, floating, fixed point, exponential, field justified, etc. etc. Even variable number of fields per record					£125/£15
Super-Sort II — Above available as absolute program only					£105/£15
Super-Sort III — As II without SELECT/EXCLUDE					£75/£15
Word-Master Text Editor — In one mode has super-set of CP/M's ED commands including global searching and replacing, forward and backwards in file. In video-mode, provides full screen editor for users with serial addressable-cursor terminal					£75/£15
Word-Star — Menu driven visual word processing system for use with standard terminals. Text formatting performed on screen. Facilities for text paginate, page number, justify, center, underscore and PRINT. Edit facilities include global search and replace, read/write to other text files, block move, etc. Requires CRT terminal with addressable cursor positioning					£255/£15
GRAFFCOM					
PAYROLL — Designed in conjunction with the spec for PAYE routines by HMI Taxes. Processes up to 250 employees on weekly or monthly basis. Can handle cash, cheque or bank transfer payments plus total tracking of all year to date figures. Prints emp master, payroll log, payslips and bank giro. Requires CBASIC-2					£475/£15
COMPANY SALES — Performs sales accounting function. Controls payments of invoices and prints sales ledger and aged debtors report. Suitable for any accounting period. Comprehensive VAT control and analysis of all sales invoices. Requires CBASIC-2					£425/£15
COMPANY PURCHASES — Performs purchase accounting function. Controls invoices, credit & debit notes. Prints purchase ledger, aged creditors report and payment advices. Comprehensive VAT control and analysis of all purchases. Interfaces with the NAD system. Requires CBASIC-2					£425/£15
GENERAL ACCOUNTING — Produces Nominal Ledger, Trial Balance, P/L and Balance Sheet. Define your own coding system. Interactive data entry plus optional data capture from Company Sales and Company Purchases. Requires CBASIC-2					£375/£15
STOCK CONTROL					
Maintains stock records, monitors stock levels to ensure optimum stock holding. Details include stock desc., product code, unit, unit price, quantity on hand on order/minimum. Stock analysis reports can be weekly, monthly, quarterly etc. Interfaces with Order Entry & Invoicing system. Requires CBASIC-2					£325/£15
ORDER ENTRY & INVOICING					
Performs order entry and invoicing function. Handles invoices for services and consumable items, part orders and part quantities. Sales Analysis report shows sales movements and trends for user-defined period Interfaces with Stock Control, NAD and Company Sales systems. Requires CBASIC-2					£325/£15
NAD — Complete control of all your names & addresses including suppliers, clients, enquiries etc. Assign your own coding system and select all output via the report generator. Will print anything from mailing labels to directories. Requires CBASIC-2					£225/£12
COMPLETE ACCOUNTING PACKAGE — Combined Company Sales, Company Purchases, General Accounting, and NAD systems					£950/£45
SALES ORDER PROCESSING PACKAGE — Combined Stock Control, Order Entry and Invoicing and NAD systems					£550/£30
STRUCTURED SYSTEMS GROUP					
ANALYST — Customised data entry and reporting system. User specifies up to 75 data items per record. Interactive data entry, retrieval and update facility makes information management easy. Sophisticated report generator provides customised reports using selected records with multiple level breakpoints for summarisation. Requires CBASIC-2, 24 x 80 CRT, printer and 48K system					£125/£10
LETTERRIGHT — Program to create edit and type letters or other documents. Has facilities to sort, display, delete and move text, with good video screen presentation. Designed to integrate with NAD for form letter mailings. Requires CBASIC-2					£105/£15
NAD Name and Address selection system — interactive mail list creation and maintenance program with output as full reports with reference data or restricted information for mail labels. Transfer system for extraction and transfer of selected records to create new files. Requires CBASIC-2					£45/£12
QSORT — Fast soft/merge program for files with fixed record length, variable field length information. Up to five ascending or descending keys. Full back-up of input files created. Parameter file created optionally with interactive program which requires CBASIC-2. Parameter file may be generated with CP/M assembler utility					£50/£12
SOFTWARE SYSTEMS					
CBASIC-2 Disk Extended BASIC — Non-interactive BASIC with pseudo-code compiler and runtime interpreter. Supports full file control, chaining, integer and extended precision variables etc.					£75/£10
GRAHAM-DORIAN SOFTWARE SYSTEMS					
APARTMENT MANAGEMENT SYSTEM — Financial management system for receipts and security deposits of apartment projects. Captures data on vacancies, revenues, etc. for annual trend analysis. Daily report shows late rents, vacancy notices, vacancies, income lost through vacancies, etc. Requires CBASIC-2. Supplied in source code					£300/£25
INVENTORY SYSTEM — Captures stock levels, costs, sources, sales, ages, turnover, markup, etc. Transaction information may be entered for reporting by salesman, type of sale, date of sale, etc. Reports available both for accounting and decision making. Requires CBASIC-2. Supplied in source code					£300/£25

Software for most popular 8080/Z80 computer disk systems including
**NORTH STAR HORIZON, VECTOR MZ, OHIO SCIENTIFIC,
 CROMEMCO, PROCESSOR TECHNOLOGY, RAIK BLACK BOX,
 DYNABYTE, SD SYSTEMS, RESEARCH MACHINES, ALTAIR,
 EXIDY SORCERER, IMSAI, HEATH, and 8" IBM formats**

- Software with Manual / Manual Alone
- CASH REGISTER** — Maintains files on daily sales. Files data by sales person and item. Tracks sales. Overrings, refunds, payouts and total net deposits. Requires CBASIC. Supplied in source code. £300/£25
 - MICRO FOCUS**
 - STANDARD CIS COBOL** — ANSI '74 COBOL standard compiler fully validated by U.S. Navy tests to ANSI level 1. Supports many features to level 2 including dynamic loading of COBOL modules and a full ISAM file facility. Also, program segmentation, interactive debug and powerful interactive extensions to support protected and unprotected CRT screen formatting from COBOL programs used with any dumb terminal. £400/£25
 - FORMS 2** — CRT screen editor. Automatically creates a query and update program of indexed files using CRT protected and unprotected screen formats. Output is COBOL data descriptions for copying into CIS COBOL programs. No programming experience needed. Output program directly compiled by CIS COBOL (standard). £100/£12
 - OTHER**
 - PASCALIZ** — Z80 native code PASCAL compiler. Produces optimised portable reentrant code. All interfacing to CP/M is through the support library. The package includes compiler companion macro assembler and source for the library. Requires 56K and Z80 CPU. Version 2 includes all of Jensen/Wirth except variant records. £155/£15
 - Version 3 Upgrade** with variant records and strings expected 2/80. £205/£15
 - PASCALMT** — Subset of standard PASCAL. Generates portable 8080 machine code. Symbolic debugger included. Supports interrupt procedure and BCD arithmetic for real variables. CP/M file I/O and assembly language interface supported. Lacks sets, Enumeration and Record data types. Manual explains BASIC to PASCAL conversion. Requires 32K. £65/£17
 - Source for PASCAL/MT run time package.** Requires MAC (See under Digital Research). £30
 - tiny C** — interactive interpretive system for teaching structured programming techniques. Manual includes full source listings. £45/£30
 - BDS C COMPILER** — Supports most major features of C language, including Structures, Arrays, Pointers, recursive function evaluation, linkable with library to 8080 binary output. Lacks data initialization, long & float type and static & register class specifiers. Documentation includes "C" Programming Language book by Kernighan & Ritchie. £60/£10
 - WHITESMITHS' C COMPILER** — The ultimate in systems software tools. Produces faster code than Pascal with more extensive facilities. Conforms to the full UNIX Version 7 C language, described by Kernighan and Ritchie, and makes available over 75 functions for performing I/O, string manipulation and storage allocation. Compiler output in A-Natural source. Supplied with A-Natural. Requires 60K CP/M. £325/£20
 - POLYVUE/80** — Full screen editor for any CRT with XY cursor positioning. Includes vertical and horizontal scrolling, interactive search and replace, automatic text wrap around for word processing, operations for manipulating blocks of text, and comprehensive 70 page manual. £70/£12
 - POLYTEXT/80** — Text formatter for word processing applications. Justifies and paginates source text files. Will generate form letters with custom fields and conditional processing. Support for dot matrix Wheel printers includes variable pitch justification and motion optimization. £45/£10
 - ALGOL 60 Compiler** — Powerful block-structured language featuring economical run time dynamic allocation of memory. Very compact (24K total RAM) system implementing almost all Algol 60 report features plus many powerful extensions including string handling, direct disk address I/O etc. Requires Z80 CPU. £110/£12
 - Z80 Development Package** — Consists of (1) disk file line editor, with global inter and intra-line facilities; (2) Z80 relocating assembler, Zilog Mostek mnemonics, conditional assembly and cross reference table capabilities; (3) linking loader producing absolute Intel hex disk file for CP/M LOAD, DDT or SID facilities. £50/£12
 - ZDT** — Z80 Debugger to trace, break and examine registers with standard Zilog/Mostek mnemonic disassembly displays. Facilities similar to DDT £20 when ordered with Z80 Development Package. £30/£7
 - DISTEL** — Disk based disassembler to Intel 8080 or TDL/Xitan Z80 source code, listing and cross reference files. Intel or TDL Xitan pseudo ops optional. Runs on 8080. £35/£7
 - DISILOG** — As Distel to Zilog Mostek mnemonic files. Runs on Z80 only. £35/£7
 - TEXTWRITER III** — Text formatter to justify and paginate letters and other documents. Special features include insertion of text during execution from other disk files or console, permitting recipe documents to be created from linked fragments on other files. Has facilities for sorted index, table of contents and footnote insertion. Ideal for contracts manuals, etc. £75/£3

- Software with Manual / Manual Alone
- POSTMASTER** — A comprehensive package for mail list maintenance. Features include sorted record extraction and label production. A form letter program is included which provides neat letters on single sheet or continuous forms. Requires CBASIC. £75/£15
 - WHATSIT?** — Interactive data-base system using associative tags to retrieve information by subject. Hashing and random access used for fast response. Requires CBASIC. £70/£15
 - XYBASIC** Interactive Process Control BASIC — Full disk BASIC features plus unique commands to handle bytes, rotate and shift, and to test and set bits. Available in integer, Extended and ROMable versions. Integer Disk or Integer ROMable. £165/£15
Extended Disk or Extended ROMable. £215/£15
 - SMAL/80** Structured Macro Assembly Language — Package of powerful general purpose text macro processor and SMAL structured language compiler. SMAL is an assembler language with IF-THEN-ELSE, LOOP-REPEAT-WHILE, DO-END, BEGIN-END constructs. £40/£10
 - SELECTOR III-C2** — Data Base Processor to create and maintain multi Key data bases. Prints formatted, sorted reports with numerical summaries or mailing labels. Comes with sample applications including Sales Activity, Inventory, Payables, Receivables, Check Register, and Client/Patient Appointments, etc. Requires CBASIC Version 2. Supplied in source code. £185/£12
 - CPM/374X Utility Package** — has full range of functions to create or re-name an IBM 3741 volume, display directory information and edit the data set contents. Provides full file transfer facilities between 3741 volume data sets and CP/M files. £125/£7
 - BASIC UTILITY DISK** — Consists of (1) CRUNCH-14 Compacting utility to reduce the size and increase the speed of programs in Microsoft Basic or TRS-80 Basic. (2) DPFUN — Double precision subroutines for computing nineteen transcendental functions including square root, natural log, log base 10, sin, arc sin, hyperbolic sin, hyperbolic arc sin, etc. Furnished in source on diskette and documentation. £30/£10
 - THE STRING BIT** — Fortran character string handling. Routines to find, fill, pack, move, separate, concatenate and compare character strings. Package completely eliminates the problems associated with character string handling in FORTRAN. Supplied with source. £30/£10
 - BSTAM** — Utility to link one computer to another also equipped with BSTAM. Allows file transfers at full data speed (no conversion to hex), with CRC block control check for very reliable error detection and automatic retry. We use it! It's great! Full wildcard expansions and *.COM, etc. 9600 baud with wire, 300 baud with phone connection. Both ends need one. Standard and M versions can talk to one another. £75/£5
 - Flippy Disk Kit** — Template and instructions to modify single sided 5 1/4" diskettes for use of second side in singled sided drives. £6



Orders must specify disk type and format, e.g. North Star-Horizon single density.

Add VAT to orders for software (not manuals alone) Add 50p per item postage and packing (minimum £1)

All orders must be prepaid (except COD or credit card) Make cheques POs etc payable to Lifeboat Associates.

Manual costs are deductible from subsequent software purchase

Lifeboat Associates
 32 Neal Street
 London WC2H 9PS
 01-379 7931

Modified version available for use with CP/M as implemented on Heath and TRS-80 Model 1 computers.

User license agreement for this product must be signed and returned to Lifeboat Associates before shipment may be made.

*CP M is a trademark of Digital Research

**Z80 is a trademark of Zilog Inc.

The Software Supermarket is a trademark of Lifeboat Associates.

EFFECTIVE JANUARY 1980

TANDY

NEW LOWER PRICES ON THE TRS 80

OVER
100,000
SOLD



TRS - 80 Model I
4K Level I.
£385.25
inc. vat.
£335.00 plus vat.

TRS - 80 Model I
16K Level II
£546.25
inc. vat.
£475.00 plus vat.

**Meet TRS-80's Big Brother!
The new TRS-80 Model II.**

Level refers to version of BASIC language. Level I is a beginners' language. Level II is very advanced. Level and memory can be expanded. All systems include Users Manual and game cassette.

For Business, Learning and Entertainment

Just think what the incredible TRS - 80 microcomputer could do for your family or business.

The TRS - 80 will take you into the world of tomorrow for less than the price of a set of encyclopedias and it can free you from routine tasks that waste so many valuable hours.

Properly programmed, it can help with your budget, manage your mailing list or teach children maths.

And, when the work is finished you can spend many enjoyable hours playing one of several pre-programmed games.

Visit a Tandy Computer Centre or any of our 180 nationwide stores and dealers for full details.



We've added a bigger, more powerful "brother" to the TRS - 80 family. It's TRS - 80 Model II - a completely new microcomputer for business applications.

Its capabilities start where TRS - 80 Model I approaches its upper limits. Order now for delivery within four-five months.

FROM £1,999 plus vat.

(Illustration. Central Processing Unit, Monitor and Disc drive TRS - 80 Model II)



The big name centers for little computers

Tandy are opening specialist TRS-80 micro-computer centers the length and breadth of Britain—(Four) are already open and new ones will be appearing all the time. So you'll be able to drop in and experiment with the TRS-80 range, discuss your needs with a TRS-80 expert and buy one over-the-counter. Each store will be backed by a service engineer to iron out any problems you may encounter when commissioning your system.

Short Teaching Courses.

Every TRS-80 Computer Center has its own classroom where inexpensive practical short courses in TRS-80

use and programming take place regularly. Anybody can use a TRS-80 the courses are designed to prove it—fast

Level 1 Basic Course—1 day

Level 2 Basic Course—2 days

Level 3 (TRS-Disc operating system) 2 days.

New TRS-80 Computer Centers Now open

Bradford—2-4 Forster Square, 0274 28431/2

Bristol—Colston Centre 0272 214721/2

Birmingham—EDGBASTON, 6 Shopping Precinct, Hagley, 021-445 9175

Manchester—30 Market Place, Deansgate. 061-832 2242

The TRS-80 48K Business System



Includes 2 Mini Disk Units and Friction Drive Line Printer for Hard copy. The ideal business system.

- 26-1006 16 K TRS-80
- 26-1142 32K Interface
- 26-1162 Disk
- 26-1161 Disk
- 26-1301 System Desk
- 26-1401 Printer Cable
- 26-1150 Friction Printer
- 26-9502 Disk Cable

Price
£2580.04
Plus VAT
£2967.05
Inc VAT

TRS-80 Model II Bigger Business System

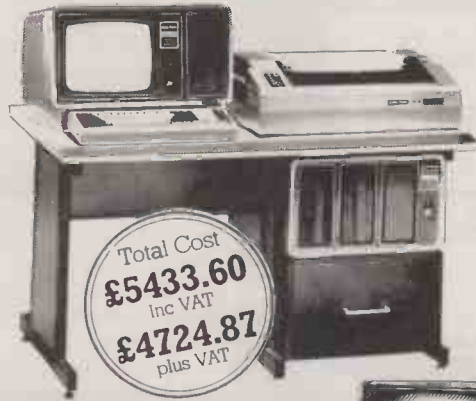

64K 2 Megabyte Model II Interfaced with Advanced Lineprinter and System Desk

Total Cost
£5433.60
Inc VAT
£4724.87
plus VAT

TANDY

THE BIGGEST NAME IN LITTLE COMPUTERS

Offers subject to availability. Instant credit available in most cases.



Access: Barclaycard and Trustcard. Check your telephone directory for your nearest store.

OVER 180 STORES AND DEALERSHIPS NATIONWIDE.



• Circle No. 252



PET 2001



from
£475

commodore
authorised dealers

TRS 80



from
£365

From Radio Shack Corp.

APPLE II

from
£750

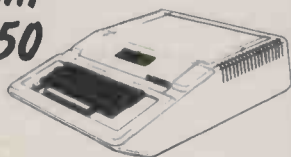

apple & ITT 2020
authorised dealers

SORCEROR

from **£740**

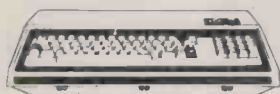

ES
authorised dealers

COMPUCOLOR

from
only
£999



148
for computer with colour monitor, keyboard and
integral disk drive. Second disk drive £316.00

MICROCOM

For Hardware, Software, Peripherals

BASIC SYSTEMS

PET 3016 (16K RAM and large keyboard)*	£675.00	PET 2001-8 (PET with 8K memory + integral cassette)	£515.00
PET 3032 (32K RAM and large keyboard)*	£795.00	New 8K PET with large keyboard	£475.00
		PET C2N External Cassette Deck	£53.00

ACCESSORIES

IEEE/RS232 Serial Interface 'A' Output only	£106.00	IEEE-448/Centronics type parallel Interface	£45.00
IEEE/RS232 Serial Interface 'B' Input/Output	£186.00	IEEE to Pet Cable	£19.00
		IEEE to IEEE cable	£24.00
		Interface to S100 (4 slot mother-board)	£112.00

BASIC SYSTEMS

TRS 80, 4K Level I consisting of Keyboard with 4K memory, Video Unit, Cassette Drive and 240v power supply unit	£365.00	TRS 80, 16K Level II (as above with 16K memory)	£499.00
TRS 80, 4K Level II (as above with Level II Basic)	£425.00	TRS 80, Expansion Interface with 16K RAM	£275.00
		TRS 80, Expansion Interface with 32K RAM	£360.00

ACCESSORIES

TVJ 232C serial Interface	£35.00	Radio Shack Phone Modem	£160.00
Centronics Parallel Printer Interface (direct to keyboard)	£54.00	UHF Modulators (encased with leads for 625 lines)	£20.00
TRS 80, Voice Synthesizer	£345.00	RAM upgrade (4-16K, 16-32K, 32-48K) supplied and fitted at our premises (Kit £80.00)	£85.00
TRS Voxbox - speech recognition system	£135.00	S100 interface for TRS 80 (6 slots)	£375.00
TRS 80, Numeric Key Pad supplied and fitted	£49.00		

BASIC SYSTEM

Apple II Plus computer - APPLESOFT extended basic in ROM - (16K RAM) - video output £750*

ACCESSORIES

Apple black and white modulator for domestic TV	£20.00	Real time clock/calendar card - 1/1000 sec to 388 days with interrupt, software controllable	£140.00
Eurocolor card - provides colour on domestic TV	£69.00	Speechlab - provides voice control for the Apple	£127.00
Parallel Printer Interface Card	£110.00	Supertalker - adds human speech output!	£205.00
High Speed Serial (RS232C) Interface Card	£110.00	ALF Music Synthesizer Card	£215.00
Communications Card	£132.00	A1-02 Data Acquisition Card	£170.00
Centronics Card	£110.00	Graphics Tablet	P.O.A.
Integer Basic Firmware Card	£110.00	AC Line Controller	£270.00
PASCAL language system - includes language card to provide user with PASCAL, PALSOFT & INTEGER BASIC	£296.00	RAM Upgrade (16-32K, 32-48K)	£69.00
		Hobby Prototype Card	£20.00
		Romplus - u, l/c, mixed text/graphics	£120.00

BASIC SYSTEMS

Sorceror 16K RAM (inc. UHF Modulator)	£740.00	Sorceror 32K RAM (inc. UHF Modulator)	£840.00
---------------------------------------	---------	---------------------------------------	---------

ACCESSORIES

Exidy Video Monitor (High Resolution)	£240.00	Exidy S100 Bus with Interface motherboard PSU	£200.00
Exidy Video Disk Unit	P.O.A.	CP/M for Sorceror on Disk	£145.00

ADVANCED SYSTEMS

Altair, Equinox, Billings, Heath, Rair, Horizon.
Installations include hard disk and multi tasking. Prices on Application.

NEWS

CORVUS 11mb Hard Disk for TRS 80 & Apple. Complete with interface & D.O.S. £3500.00

TANDY Model II now available for demonstration at our Camberley Office. (by appointment only)

P.O.A.

PUTERS ETC

Consultancy and Competitive Prices.

Registered business name



DISKS

PET	
CBM 3040 (dual drive) 343K User storage*	£795.00
Computhink (dual drive) 400K storage	£895.00
Computhink (dual drive) 800K storage	£1145.00
TRS80	
Shugart drive	£315.00
Micropolis drive	£315.00
Percom FD200 drive 110v	£299.00
Micropolis Dual Drive (394K storage)	£995.00
Corvus Hard Disk (11mB)	£3500.00
APPLE	
Apple Drive - 116K storage 1st drive	£398.00
Apple Drive - 116K storage 2nd drive	£355.00
Corvus Hard Disk (11mB)	£3500.00
SORCEROR	
Exidy - 143K storage	£495.00
Exidy Dual drive (630K storage)	£1195.00
Corvus Hard Disk (11mB)	£3500.00

PRINTERS

PET	
CBM 3022 (80 col with PET graphics - tractor feed)*	£675.00
TRS80	
TRS 80 Screen Printer (text - graphics) (110v)	£445.00
New Radio Shack Micro Printer	£245.00
GENERAL	
Teletype 43 KSR Serial (pin or pinch feed, 132 cols)	£825.00
Teletype 33 KSR Serial (110 Baud) Reconditioned	£550.00
OKI parallel serial (pin or pinch feed, 80 cols)	£499.00
Centronics 779 parallel (tractor feed, 132 cols)	£825.00
Anadex DP 8000 serial parallel (112 cps bi-directional tractor feed, 40, 80 cols selectable)	£560.00
Centronics Micro Printer (20, 40, 80 cols selectable)	£395.00
Heath WH 14 serial (80, 96, 132 cols selectable)	£510.00
QUME daisy wheel printers	P.O.A.
TCM100/MICROHUSH Thermal Printer (40 cols) inc. interface for PET/APPLE TRS80	£266.00

ETC.

Diskettes 5 1/4" (blank) boxed (min order 10) each	from £3
C12 Cassettes (min order 10) each	£0.35p
Ansaback 'phonemate' telephone answering machine, voice operated twin cassette	£190.00
Pace EZ-PHONE - Cordless Telephone	£225.00
Computalker Speech Synthesis for S100	£350.00

BOOKS - Large range of microcomputer-related books and magazines

TERMINALS

Pentland V1, 80 char./24 lines 2 page memory	£580.00
--	---------

IF YOU DON'T SEE IT - ASK IF WE HAVE IT

SOFTWARE

PET

PETSOFT authorised dealers - over 160 programmes on cassette and disk. Send for catalogue.

STAGE ONE COMPUTERS S/W dealers - PETAID, Stock Control, etc. Send for list. Programmers Toolkit - 10 powerful new commands for your Pet - plug in ROM chip 8K and 16/32K resp

74 Common BASIC Programs on one tape £75/£55
 PETAID Business Software - Sales and Purchase Ledger £15.00
 P.O.A.

CBM DISK-BASED BUSINESS SOFTWARE:-

Commodore Word Processor powerful word processor package £75.00
 CSTACK - STOCK CONTROL - gives complete stock report £150.00

CBIS - BUSINESS INFORMATION SYSTEM - Storage & Retrieval of all types of company records £150.00

(We are authorised CBM Business Software Dealers)

JOYSTICK PACKAGE - complete with connector software £25.00

CAR INSURANCE QUOTATIONS - computerised car insurance quotation

suitable for insurance brokers (TVJ S/W) £25.00

MORTGAGE QUOTATIONS - suitable for agents/mortgage brokers (TVJ S/W) £25.00

TRS 80

COMAC III SUITE - computerised accounting for TRS 80 (TVJ SOFTWARE) £75.00

STOCK CONTROL - complete inventory control - recorder level - P/O's etc. £115.00

CP/M

CBASIC £95.00

FORTRAN includes compiler, relocatable assembler text editor and linking loader £75.00

PASCAL - tomorrow's programming language today £85.00

ELECTRIC PENCIL - powerful word processor allows full cursor movement, insert/delete, string search block movement, adjustable line length, justification on cassette £195.00

ELECTRIC PENCIL as above - disk version £65.00

LOWER CASE MOD KIT for Electric Pencil £115.00

DATA MANAGEMENT/REPORT GENERATOR - easily formats disk files, allows entry, edit, delete and list of records and retrieves data for display or calculation on screen or printer £28.00

RSM-2D DISK MONITOR - powerful system manipulates disk data, has Z-80 break routine £200.00

ISAM - INDEX SEQUENTIAL ACCESS METHOD - sub routines to facilitate control of random data files £25.00

ST80D communications software £45.00

NEWDOS - TRSDOS with corrections and enhancements £60.00

NEWDOS - as above but with further facilities - £25.00

KBFIX, Renum, Screen to printer in one step, DOS commands from BASIC, Level I in II, Superzap, Disassemble, load and save faster, list variables £45.00

LIBRARY 100 - an assortment of 100 programs £49.00

SARGON CHESS - 16K Level II - the 1979 Champ Version I £39.00

SARGON CHESS - 16K Level II - the 1979 Champ Version II £14.00

£24.00

APPLE

EASYWRITER - word processing system £85.00

A2FP FUNCTION PLOTTER - Comprehensive graph plotting £18.00

PILOT - programming language suitable for educational purposes £35.00

U-DRAW II - High Resolution graphics editor. Create a figure then intake, expand, contract etc and store on disk £27.00

PROGRAMMERS AID No. 1 - Plug-in ROM gives numerous facilities including renumber, merge, high res in integer etc £29.00

3D GRAPHICS - High res plotting in 3D! £30.00

LISP - programming language suitable for research in artificial intelligence £30.00

3-MILE ISLAND - Complex disk based game simulating nuclear reactor £27.50

MUSE authorised dealers. Many programs on cassette and disk. Send for list.

SORCEROR many programs available - send for list.

COMPUCOLOR full lists available

* 5% DISCOUNT ALLOWED FOR EDUCATIONAL ESTABLISHMENTS



T&V JOHNSON (MICROCOMPUTERS ETC) LTD

Hours of business
 Mon-Fri. 9.30 - 5.30
 Sat. 9.30 - 1.00

Member of the TV Johnson Group of Companies

Camberley (Head Office)
 165 London Road, Camberley
 Surrey, GU15 3JS.
 Telephone (0276) 62506

Oxford
 148 Cowley Road, Oxford
 OX4 1JJ.
 Telephone (0865) 721461

Bristol
 48 Gloucester Road, Bristol
 BS7 8BH
 Telephone (0272) 422061

Ansaback eyes and w/ends.
 Telex 858893



PRICES EXCLUDE VAT, FREIGHT & HANDLING SEND OR PHONE FOR PRICE LIST & BROCHURES (All prices correct at time of compilation)

Directors: Dr. R.V. King BA, MIEE
 S.G. Johnson, BSc. (Hons.)
 T.S. Johnson, ABIBA, ACMB, FBSC, MBIM
 A.S. Barton ACII, ABIBA, CdiPAF

Branches at: 149
 Birmingham, Bristol, Edinburgh, Leeds, London, Louth, Newmarket, Nottingham, Oxford, Byfleet, Wokingham.

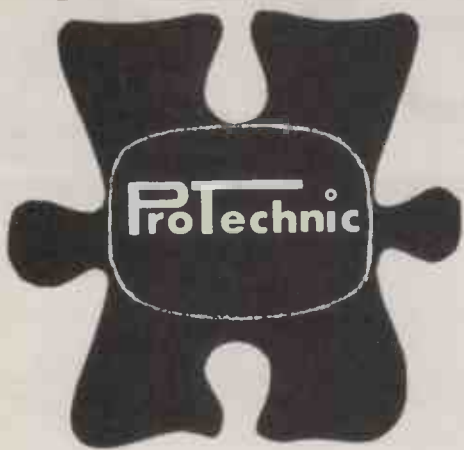

WE HAVE ALL THE PIECES!

COME TO CAMBRIDGE AND SEE THE SOLUTION

We can demonstrate practical business systems,
with proven software, for many applications.

Leasing, installation and training available.

PROTECHNIC COMPUTERS LTD.

264 Newmarket Road, Cambridge.

0223 - 314855

• Circle No. 254

PRINTERS FOR PET

- Plug connectable. 2001 and 3001
- Full Character Set and Graphics and Cursor Signs
- Variable Character Size
- Reverse Print
- Paper roll or Reversible Tractor Feed
- £ sign
- 100-120 CPS Bi-directional
- 5×7, 6×7, 9×7, Dot Matrix
- 52-80 Print Positions
- Alternative Interfaces — RS232 and Centronix

PRICES FROM £450

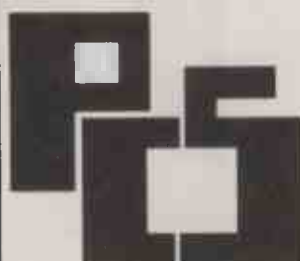

PARAMETERISED
COMPUTER
SYSTEMS LTD

250 Brompton Road
London SW3

• Circle No. 255

TRS-80 OWNERS!

LEVEL II CASSETTE

ADVENTURE (LAND)*	£ 7.50	ACCOUNTS RECEIVABLE	£ 12.50
ADVENTURE (PIRATES)*	£ 7.50	APPOINTMENT LOG	£ 5.00
AIR RAID*	£ 7.50	ASTRONOMY II	£ 6.50
AMAZIN' MAZES	£ 4.00	BIORYTHMS	£ 3.00
BACKGAMMON	£ 4.00	CALENDAR FUNCTIONS	£ 6.50
BALLOON RACE	£ 5.00	CALCULATOR	£ 3.00
BARRICADE*	£ 7.50	CASH REGISTER	£ 5.00
BASEBALL	£ 4.00	COMPLEX MATHS	£ 6.50
BATTER UP	£ 3.00	CURVE FITTER	£ 6.50
BINGO	£ 3.00	ELECTRIC PENCIL*	£ 50.00
BOWLING (TEN PIN)	£ 4.00	ELECTRONICS ASSISTANT	£ 5.00
BREAKAWAY	£ 3.00	ESP TESTER	£ 3.00
BRIDGE CHALLENGER	£ 7.50	FILE HANDLING	£ 6.50
DOGSTAR	£ 5.00	FINANCE (LOANS & INVEST)	£ 6.50
END ZONE	£ 4.00	FINANCIAL PACK I	£ 6.50
FASTGAMMON*	£ 7.50	FINANCIAL PACK II	£ 6.50
GALACTIC BLOCKADE	£ 4.00	FOURIER TRANSFORMS	£ 6.50
HAMURABI	£ 3.00	GENERAL ACCOUNTING	£ 7.50
HANGMAN	£ 3.00	HAM RADIO	£ 5.00
KAMIKAZE	£ 4.00	HOME FINANCE	£ 5.50
KENTUCKY DERBY	£ 3.00	INVENTORY MOD.	£ 10.00
LUNAR LANDER	£ 4.00	INVENTORY FP.	£ 12.00
MASTERMIND*	£ 4.00	INVENTORY CONTROL	£ 10.00
MICROCHESS*	£ 10.00	KEYBOARD-80	£ 5.00
MISSION IMPOSSIBLE*	£ 7.50	KVP EXTENDER	£ 12.50
OTHELLO III	£ 3.00	LEVEL III BASIC	£ 25.00
PENTOMINOES	£ 5.00	LINEAR PROGRAMMING	£ 6.50
PORK BARREL	£ 5.00	MATH DRILL	£ 3.00
REMAINDER	£ 4.00	MICROTEXT	£ 5.00
ROBOTS	£ 3.00	MORTGAGE CALCULATOR	£ 4.00
ROUND THE HORN	£ 5.00	NUMERICAL INTEGRATION	£ 6.50
SAFARI	£ 4.00	PERSONAL FINANCE	£ 5.00
SANTA PARAVIA	£ 4.00	PRE-FLIGHT	£ 10.00
SARGON*	£ 10.00	RPN CALCULATOR	£ 5.00
SINK'UM	£ 3.00	RENUMBER*	£ 7.50
SPACE BATTLES	£ 7.50	ROOT FINDER	£ 6.50
STARTREK III	£ 7.50	SCREEN PLOTTER	£ 6.50
TIME BOMB	£ 3.00	SIMPLE SIMON	£ 3.00
TREASURE HUNT	£ 3.50	STATISTICS I, II, III	£ 5.50
TREK 80	£ 5.00	STAR FINDER	£ 6.50
TAIPAN	£ 7.50	SYSTEM COPY*	£ 7.50
TYCOON	£ 4.00	LIBRARY 100	£ 37.50
X-WING FIGHTER	£ 4.00	75 BASIC PROGRAMMES	£ 20.00
WARFARE I	£ 4.00	MANJAL FOR ABOVE	£ 6.00

DISK

ACCOUNTS RECEIVABLE II	£ 40.00
ADVANCED PERSONAL FIN.	£ 12.50
AMATEUR RADIO SYSTEM	£ 12.50
GENERAL LEDGER II	£ 40.00
INVENTORY 2.2	£ 30.00
INVENTORY 2.3	£ 40.00
INVENTORY II	£ 50.00
LEVEL I IN LEV II RAM	£ 12.50
MAIL LIST II	£ 50.00
NEVDOS+	£ 47.50
TEXT-80	£ 30.00
ST 80-D	£ 40.00
TARANTO & ASSOCIATES CONVERSION OF OSBORNE & ASSOCIATES BUSINESS PROGRAMMES.	
ACCOUNTS PAYABLE	£ 90.00
ACCOUNTS RECEIVABLE	£ 90.00
GENERAL LEDGER	£ 90.00
PAYROLL	£ 90.00
MANUALS FOR ABOVE	£ 10.00
76 BASIC PROGRAMMES	£ 15.00
MANUAL FOR ABOVE	£ 6.00
* DENOTES MACHINE LANGUAGE SEND 50P FOR FURTHER DETAILS OF ABOVE PROGRAMMES. ADD 50P TO ORDERS UNDER £20.00 DEALER ENQUIRIES INVITED. ALL LISTED PROGRAMMES IN STOCK. FOLLOWING AVAILABLE TO ORDER.	
FORTRAN	£100.00
CP/M	£ 75.00
MMSFORTH CASSETTE	£ 20.00
DISK	£ 25.00
PILOT	£ 12.50



MICROCOMPUTER APPLICATIONS

11 Riverside Court, Caversham,
Reading, RG4 8AL, England.

Buy here at discount prices!

- ☆ Full after-sales service in our own workshops
- ☆ One year guarantee on all machines

Save money.

Improve your 8K PET with memory expansion boards

internally mounting, full instructions supplied, plug and socket connections only

24K £249

24K to support disc drives £320
32K to support disc drives £432

Free Installation

Credit terms available

The only 16k complete computer for under £400

keyboard, computer, power supply, UHF modulator and all cables to plug into your own TV set and cassette recorder and go!!

16K of user RAM for decent size programmes and data, sophisticated level II microsoft basic.

Fully converted to UK standard including frame sync, frequency (no wobbly display).

Tandy don't do this! Complete with level I and level II programming manuals. What more could you ask?

£399

Extra numerical keypad £33.95

Expansion interface complete with 32K RAM £299

This lot must be today's best buy!

Get into print this easy way!

Fast! Immaculate! Silent!



Anadex DP 8000 dot-matrix printer

*Speedy 112 ch/s bidir. *Fits A4 page—up to 80 cols. *Up to 4 copies. *Precision form-filling with sprocket feed. *Special headings using double-width chars. *Modern paper format to match A4 filing systems. *Other paper sizes with adj. sprocket. *Full punctuation, U/L case, £ sign, 96-ch. set. *Reliable — strongly built, 100 M.ch. head.

Knock down price!

£499

Interfaces - Pet £45 Ohios £10
TRS-80 £12 Sorcerer £6
Apple £69



IBM golfball printer ideal for word-processing

*Forget expensive Spin-Wheel printers — the Golfball produces equal quality at up to 15 ch. per sec. *Match various typewriter styles with IBM interchangeable heads. *Completely reliable — each machine rebuilt by IBM trained engineers and fully guaranteed. *Precision form-filling possible with 15 in. pin-feed platen.

Limited supply!

£595

Interfaces - Pet £45 Ohios £10
TRS-80 £12 Sorcerer £6
Apple £69



Trendcom 100 thermal printer

*Stop disturbing others with noisy printout! *Neat, clear, 96-ch.set, U/L case & symbols. *Matches Pet/Apple line lengths. *Fast, 40 ch/s bidir. *Reliable — robust — only two driven parts. *Plug in and go, built in PSU, detailed manual. *Thermal paper 4½ in wide x 80 ft, less expensive than electro-sensitive paper.

A snip!

£249

Interfaces - Pet £45 Ohios £10
TRS-80 £12 Sorcerer £6
Apple £45

While stocks last



NEW 2001-8N

(8K RAM
New large keyboard)

£499

2001 — 16N (16K RAM and new large keyboard) £590
2001 — 32N (32K RAM and new large keyboard) £690

External cassette deck, suitable for all Pets £53
CBM dual drive mini floppy £745
CBM tractor feed printer with Pet graphics £605

PET

Converted to UK frame sync.
(no wobbly display)
— no one else does it!

Make PET talk to the outside world

IEE/RS232 serial i/f input/output £140
IEE/RS232 serial i/f output £89
Pet to S100 4-slot motherboard £112
Pet to TV improved adaptor — connects to aerial socket £25

IEE/Centronics parallel i/f **£45**

COMPUTERAMA

LTD.

Tel: Bath (0225) 28819

Your dealer for Bath, Bristol and S.W.

Computerama Ltd.
Harpers Kensington
Showrooms
London Rd. Bath, Avon



Credit card orders accepted by telephone for immediate despatch.

Please add £10 Securicor delivery on computers etc. plus 15% VAT on all prices

Leasing available to companies

• Circle No. 257

REAL-TIME SPECTRUM ANALYZER £340

You can now buy, for about one-sixth the price of current products, a third-octave spectrum analyzer with more features and capabilities than were previously available at any price. What's the catch? If you don't already own a Commodore PET computer (or, soon, a Radio Shack TRS-80 or Apple), you'll have to get one. This will raise the price to somewhat under one-half the price of competing products, but of course you'll also have a COMPUTER!

The THS 224 REAL-TIME FREQUENCY ANALYZER comprises a single circuit board which installs inside the PET. This board contains a set of 31 third-octave filters (20 Hz to 20 kHz), detectors, an analog-to-digital converter, a 1K Read Only Memory containing machine language routines which allows the PET processor to interface with the Analyzer, and the peripheral circuitry necessary to transfer analog data into the PET memory. The simplest BASIC program required to turn the PET into an analyzer is only three statements long! Much longer programs can be written to allow complete user interaction with the analyzer, including many new forms of statistical signal processing, curve weighting, voice recognition etc.



EXPANSION MEMORY

with space for eprom

Price break-through

24k
£280

32k
£325

All items can be seen and demonstrated at our London showroom. Orders accepted by mail, phone or in person.

PETS 8k from £495

PET IS A TRADEMARK OF COMMODORE BUSINESS SYSTEMS

Prices exclude VAT. Send or phone for further details and brochure.

Access, Barclaycard, and Trustcard accepted.



UK Distributors

Feldon Audio Ltd.,

126 Great Portland Street, London W1 Tel: 01-580 4314 Telex: London 28668

• Circle No. 258

You're invited to come and see the **Pet**™ BUSINESS SYSTEMS at your official

COMMODORE  and **Petsoft**

dealers in ... *South West London*

Combine the NEW large keyboard PET with the ACT PETSOFTE Professional Disk Systems and Software, and the result is a powerful business tool. If your application includes Sales Ledger, Invoicing, Purchase Ledger, Payroll or Stock Control, then come and see us without delay.

MICRO COMPUTER CENTRE

Virage Holding Co. Ltd.

314 Upper Richmond Road West
East Sheen
London SW14

Tel. 01-876 6609

• Circle No. 259

Buy a System...Not just a "Pretty Box"

The SD System* — From about 97p per hour (40-hour week)



*The SD System includes:

SDS-200 Microcomputer T.I. 810 Printer (or equivalent)
i.e., NEC SPIN WRITER £1,899. SDS 200 £4,750, T18 10
£1,499

The SDS-200 TOTAL System features:

System Hardware

The SDS-200 gives you features that are not found in systems costing thousands more. State-of-the-Art Engineering. Quality Production and Full Reliability testing make the SDS-200 a dependable, compact and easy to operate data processing system.

- Up to 256K Bytes RAM
- Full Keyboard with Special Accounting Key Pad
- Large 12in. Video Display Screen
- Full Cursor Control including Addressable Cursor
- Blinking, Underlining, Reverse and Protected Fields
- Uses 8in. Flexible Diskettes for Permanent Storage 2 Mbyte on-line
- Forward and Reverse Scrolling
- Capable of up to 160 Special Characters
- Expandable with Memory and Peripheral Equipment
- Will Operate as a Remote Batch Processor for Large Systems
- S 100 industry standard bus
- 4 spare S100 slots.

System Software

A range of Business Programs are available from CAP-CPP written in Microcobal.

The system will support all normal high level languages including:—

Fortran
Cobol
Basic
CP/M

Authorised dealers are:

Anglo American Computers Ltd
Milburn House, Suite D, Dean Street
Newcastle-upon-Tyne.
Tel: 0632 29593

Bell Computing Ltd
62 Lowther Street
Carlisle 0228 43690

Peter McNaughton Ass.
Anfield, Glenalmond
Perthshire 073-888 267

Codified Computer Systems Ltd,
69 Calabria Road,
London N5 1HX
Tel: 01-226 1319.

Picodyte
Linton House,
Catherine Street
Aston, Birmingham
Tel: 021-328 4840
Telex: 335511

Optimal
142 Britannia Street
Valletta, Malta
Tel: 356 21818
Telex: Malta 683.

A Total System

SD Systems knows that small businesses do not keep full-time programmers on staff. We also know that individually designed business programs can be expensive on a one-time basis. That is why we offer the SDS-200 and compatible business software.

Leasing Available

The SDS-200 is available by leasing. This gives the small business the opportunity to select the method of acquisition that best fits their needs.

SD SYSTEMS

SDS-200 Expandable

The SDS-200 is designed in a manner to give you expansion capabilities. As your needs change the computer system that you select today should be able to change with you. By the addition of memory and peripheral equipment, the SDS-200 can expand to fit your needs.

Barcellof Ltd
Kimberley House,
Vaughan Way, Leicester

UK Distributor:
AIRAMCO LTD
Unit A2, 9 Longford Avenue, Kilwinning Ind. Est.,
Kilwinning, Ayrshire KA13 6EX.
(0294) 57755 Telex 779808

Dealer enquiries invited

• Circle No. 260

INTEGRATED SMALL BUSINESS SOFTWARE

- ISBS -

FAST AND EASY TO USE ISBS MEANS INCREASED EFFICIENCY AND PROFITABILITY - PUT IT TO WORK FOR YOUR BUSINESS

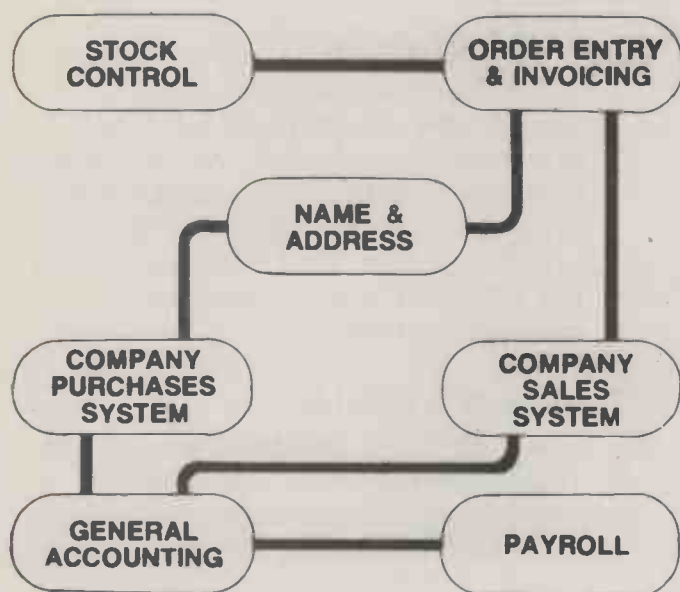

ISBS	£
STOCK CONTROL	350
ORDER ENTRY & INVOICING	350
NAME & ADDRESS SYSTEM	250
COMPANY PURCHASES SYSTEM	450
COMPANY SALES SYSTEM	450
GENERAL ACCOUNTING	400
PAYROLL	500

Packages supplied on floppy disk with easy to follow Reference Manuals — NO PREVIOUS COMPUTER KNOWLEDGE REQUIRED TO OPERATE. ISBS runs on 48K Northstar Horizon, Rair Black Box or other systems supporting CP/M* — plus VDU and 132 col printer. Complete suite or individual packages available now and are fully supported.

Other software packages available include Time Recording Systems, Finance Control and many others. Special application software undertaken for Northstar & Black Box and also complete TURNKEY SYSTEMS.

*CP/M registered trademark of Digital Research.
Costs shown exclusive of VAT.
Dealer enquiries welcome.

GRAFFCOM

52 SHAFTESBURY AV. LONDON W1.
01-734-8862

• Circle No. 261

YOU NEED MICROCOMPUTERS NOW!

Don't be left behind. In five years every progressive business in the country will have computer facilities. This will enable a reduction in their administration costs, therefore lowering their unit cost price plus being able to release administrative staff for more cost effective work.



Micro Management will help you harness this new technology and allow you to compete successfully in the future. We can provide technical and accounting expertise in a language you can understand.

He who hesitates

MICRO MANAGEMENT

The Computer People

13-15 CONNAUGHT AVENUE, FRINTON-ON-SEA
Tel: Frinton 4592.

• Circle No. 262

Considering a Microcomputer?

Be Sure to Check Out the Product Offerings of the World's Largest Full Line Microcomputer Company.

All Ohio Scientific machines come with microcomputing's fastest full feature BASIC-in-ROM or on-Disk for instant use.

Challenger I Series

Economical computer systems that talk in BASIC.

Ideal for hobbyists, students, education and the home.

	Minimum Configuration	Base Price
Superboard II - World's first complete system on a board including keyboard, video display, audio cassette, BASIC-in-ROM and up to 8K RAM	4K RAM	£ 188
Challenger IP - Fully packaged Superboard II with power supply	4K RAM	£ 238
Challenger IP Disk - Complete mini-floppy system expandable to 32K RAM	16K RAM	£ 865

Challenger IIP Series

Ultra high performance BUS oriented microcomputers for personal, educational, research and small business use.

C2-4P - The professional portable	4K RAM	£ 404
C2-8P - The world's most expandable personal machine for business or research applications	4K RAM	£ 548
C2-4P Disk - The ultimate portable	16K RAM	£ 1050
C2-8P Single Disk - Ideal for education, advanced personal users, etc.	16K RAM	£ 1199
C2-8P Dual Disk - Most cost effective small business system	32K RAM	£ 1790

Challenger III The Ultimate in Small Computers

The unique three processor system for demanding business, education, research and industrial development applications.

C3-S1 - World's most popular 8" floppy based microcomputer	32K RAM dual floppys	£ 2334
C3-OEM - Single package high volume user version of C3-S1	32K RAM dual floppys	£ 2334
C3-A - Rack mounted multi-user business system directly expandable to C3-B	48K RAM dual floppys	£ 3403
C3-B - 74 million byte Winchester disk based system. World's most powerful microcomputer	48K RAM dual floppys	£ 8654
C3-C - 29 million byte Winchester disk based system.	48K RAM dual floppys	£ 6320

Full Business and Data base Software

OS.AMCAP - A complete small business accounting package including inventory, invoicing, A/R, A/P, CR, CD, general ledger and P/L	£ 656
OS.DMS - Data base Management System designed specifically for small business information management.	£ 175
-DMS based modules for Inventory/order, A/R & A/P, General Ledger, personnel/payroll, Query, Word Processing.	£ 175 each
WP-2 - Complete word processing system with character justification, global editing, paging, text justification, proportional spacing and hyphenation.	£ 116

-ALL PRICES ARE EX VAT.

OHIO SCIENTIFIC also offers you the broadest line of expansion accessories and the largest selection of affordable software!

Compare the closest Ohio Scientific Model to any other unit you are considering. Compare the performance, real expansion ability, software and price, and you will see why we have become the world's largest full line microcomputer company.

I'm interested in OSI Computers. Send me information on:

- Personal Computers Small Business Computers
 Educational Systems Industrial Development Systems

Name _____ MICROCOMPUTER BUSINESS MACHINES
 Address _____ 4 Morgan Street,
 _____ London E3 5AB
 _____ Tel: 01-981 3993
 Phone _____

WE ARE LOOKING FOR DEALERS THROUGHOUT EUROPE
 PHONE MARK STRATHERN ON 01-981 3993



The C2-4P
The Professional Portable
by Ohio Scientific

Ohio Scientific now offers you the world's most powerful portable personal computer in both BASIC-in-ROM and more floppy configurations.

C2-4P Model 8 Standard Features

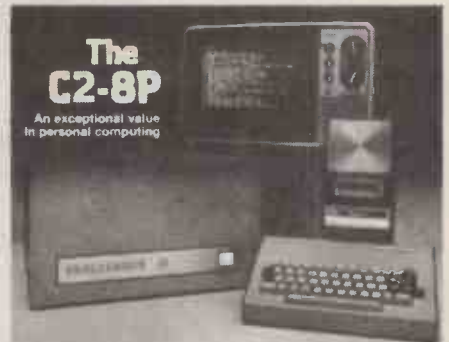

The C2-8P
An exceptional value
in personal computing

If you are interested in an ultra high performance microcomputer which can be fully expanded to a multi-user data microcomputer, look for the C2-8P.



The C3-B

The world's most powerful microcomputer system is far more affordable than you may think!

STANDARD FEATURES

**data
dams**
OFFICE EQUIPMENT LTD.,
30-36, Dale Street,
Liverpool

WE CAN HELP YOU WITH:

PETS: PRINTERS: DISKS

2001(32K) £715	CBM 3022	£675 inc cable	CBM 3040	£880
2001(16K) £607	ANADEX	£650	COMPU	{400K £875
2001(8K) £495	TELETYPE 43	from £889	THINK	{800K £1095

SOFTWARE

PETAID: From Stage One Computers, disk based file handling in hours, not weeks – possibly the most useful piece of software available for PET. CBM or COMPU-THINK £140

PETACTION: Well written business systems covering Sales & Purchase Ledger, Invoicing, and Stock Control: from £270

Many more items in stock

For details of these and many more products and services; telephone:-

IAN KENDRICK ~ 051-227-3301

• Circle No. 264

Tridata + MICROS = SOFTWARE

Business systems available now for the TRS 80

Sales Ledger (OPEN ITEM/DEBTORS ANALYSIS/STATEMENTS/INVOICES/VAT/DAYBOOKS etc.) from £150

Purchase Ledger (OPEN ITEM/CREDITORS ANALYSIS/REMITTANCE ADVICE/VAT/DAYBOOK etc.) from £150

Invoicing (UPDATES SALES LEDGER/DOWNDATES STOCK/MAINTAINS BACK ORDERS) £75

Stock Control (ISSUES/RECEIPTS/MOVEMENT, USAGE, VALUATION, RE-ORDER REPORTS etc.) £200

Payroll (WEEKLY, MONTHLY, CASUAL STAFF/BONUS SCHEMES/COIN ANALYSIS/PAYSLIPS etc.) £218

Nominal Ledger (Available shortly)

12 MONTH WARRANTY ON ALL PACKAGES - TAILORED SYSTEMS TO YOUR REQUIREMENTS

FOR THE BEST IN PROFESSIONAL MICRO BUSINESS SOFTWARE CONTACT US DIRECT OR CALL YOUR NEAREST TRIDATA DEALER FOR A DEMONSTRATION.

CAMBRIDGE COMPUTER STORE (CAMBRIDGE)	0223 68155
COMPUTER DEVELOPMENT SERVICES (SWANSEA)	0792 26085
ELECTRON SYSTEMS (SANDY, BEDS.)	0767 81195
A. J. HARDING (BEXHILL, E. SUSSEX)	0424 220391
KATANNA MANAGEMENT SERVICES (CHELMSFORD)	0245 76127
OPTRONICS (TWICKENHAM)	01 892 8455
GPW ELECTRONICS LTD (PORTSMOUTH)	0705 693341

Tridata Micros Ltd.
Smithfield House
Digbeth
Birmingham B5 6BS
Tel: 021 622 6085

• Circle No. 265



A division of
CRAYWORTH (COMPUTER SERVICES) LTD.

SHOWROOM and OFFICES

34B London Road, Blackwater,
Camberley, Surrey.

Telephone: 0276 34044. Telex 858893

open Monday-Friday 9 a.m.-6 p.m.

Saturday 10 a.m.-5 p.m.

by appointment only

Personal Callers Welcome.

Please phone first if you require a personal demonstration.

*Sorcerer CP/M Software

CP/M operating system MAC macro assembler
SID symbolic debugger TEX text formatter.
DESPOOL simultaneous print utility.
TEXT WRITER II text formatter.
SELECTOR II multi-key database (requires CBASIC 2)
CBASIC-2 pseudo-code compiler.
DIZILOG Z-80 disassembler.

*Specially designed software need not be expensive

We specialise in producing well designed and constructed software with full documentation, user training and a guarantee.

We can quote on a fixed price or time and materials basis. We require only one third payment on commencement of software projects, one third on delivery and one third AFTER the guarantee period. We can then provide an annual maintenance agreement.

Cromemco System 3

- *multi-user
- *Fortran
- *Word Processing
- *early delivery
- *Basic
- *Assembler
- *Mailing lists
- *finance available
- *Cobol
- *Data-Base management
- *Labels

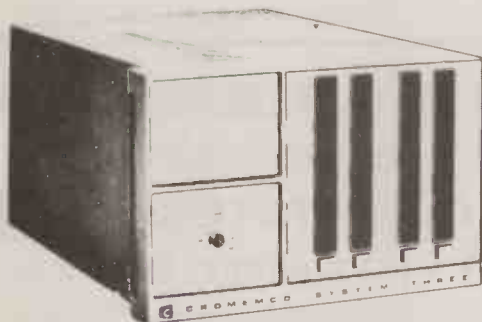

Cromemco Z2

The outstanding Cromemco Z2 with fast Z-80 CPU and 21 slot S-100 backplane. Software includes EXTENDED BASIC, ASSEMBLER FORTRAN, COBOL, DATA BASE MANAGEMENT and WORD PROCESSING.



Exidy Sorcerer

32K Machine with Z80 processor and 8K ROM BASIC.
128 character ASCII keyboard and superb graphics.
DOUBLE DRIVE configured MICROPOLIS DISK SYSTEM with MDOS or CP/M 630Kb. Professional quality monitor, various sizes up to 16".

Alternatively, now available, the new VIDEO-DISC UNIT incorporating dual disc drive and screen. Printer — optional 80 or 132 column printer. Software packages are available, including the Word Processing EPROM PAC, or can be written to your own specification. The system can be expanded to suit your own applications.

Dolphin BD-80 Printer

80 column, bi-directional, the best in its price range.

Dealer enquiries invited.

PRINTERM 879 — Matrixprinter 120 cps.

OKI DP100 — 132 column 275 cps 1251 pm.

SPINWRITER — high quality printer, ideal for word processing functions.

BURNT HILL BH720 VDU.

ELBIT DS 1920X.

MONITORS — Professional quality 9" & 16".

COMPUTER BOOKS — A wide range of micro, mini & mainframe books. Full catalogue available.

MEDIA — Floppy discs, library cases, cassettes.

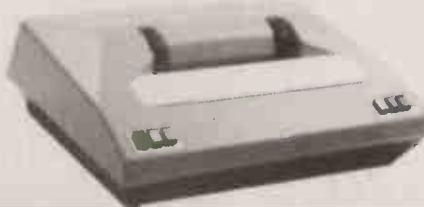

SLOUGH MICROSHOP

We stock:

Commodore PET
Exidy Sorcerer
North Star Horizon

Full demonstration equipment available now.

Extra services include:

A complete hardware maintenance service

A software service; tailor-made or packaged software available

Call in at our showroom

120 High Street,
Slough, Berkshire

Tel: Slough 22855/72470

• Circle No. 267

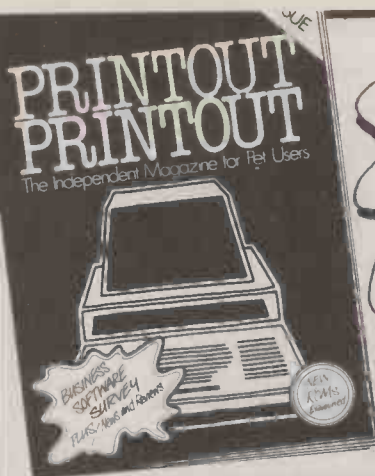

Exclusive arrival
of the
SUPER PETS

Interested in **PET?**

PRINTOUT

The Independent Magazine for Pet Users

... reports on the latest developments in the Pet world and conducts tests on software and peripherals.

Send 95p for a sample issue or £9.50 for a year's subscription (10 issues).

Printout Publications

Greenacre House, North Street, Theale, RG7 5EX

Telephone: Slough (0753) 20814

• Circle No. 268



databank software services.

101 PROGRAMS FOR FIVE COMPUTERS

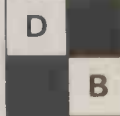

INTRODUCING

SOFTSPOT

IF YOU HAVE AN 8K OR LARGER VERSION, OF ONE OF THE COMPUTERS LISTED BELOW- THEN THIS IS FOR YOU!! A CASSETTE MAGAZINE....

EACH ISSUE OF 'SOFTSPOT' WILL HAVE LOTS OF INTERESTING GOODIES ABOUT COMPUTING. i.e.

GAMES, EDITORIAL, TECHNICAL TALK, AT LEAST 5 PROGRAMS, COMPUTER PROBLEMS PAGE etc.

SOFTSPOT COSTS ONLY £3.50 PER ISSUE, OR £30 YEARS SUBSCRIPTION. (10 ISSUES PER YEAR).

- APPLE II · PET · SORCERER · I.T.T.-2020 · TRS-80 -

CASSETTE SOFTWARE

PAYROLL-£20, STOCK CONTROL-£25, BANK ACCOUNT TALLY-£6, SALES & PURCHASE-£20, CASH REGISTER-£15, DATABASE-£25, MAILING LIST-£18, BINARY-£5, HEXADECIMAL-£5, BASIC TUTOR-£8, SNOOKER-£10, PHYSICS-£5, MATHEMATICS-£5, JET FLIGHT-£5.

PHONE US- OR WRITE FOR DETAILS, YOU MUST SEE OUR CATALOGUE NOW!

66, QUEENS ROAD,
LOUGHBOROUGH, LEICESTERSHIRE. LE11 1HD.

SPECIAL OFFER:-

TWO GREAT OFFERS FROM THE DATABANK-

EVERY ORDER OVER £10 WILL RECEIVE THE CURRENT ISSUE OF 'SOFTSPOT' ABSOLUTELY FREE OF CHARGE.

SO WHY DELAY ?
ORDER NOW!!

ALSO- AT A FRACTION OF THE NORMAL PRICE- ANY SIX OF OUR GAMES/EDUCATIONAL PROGRAMS FOR ONLY: **£20** inc. P & P.

OUR CATALOGUE IS YOURS FOR THE ASKING- LOUGHBOROUGH 0509 217671

ITT & APPLE DISK USERS:

AT LAST- A MAILING ADDRESSER AND A STANDARD LETTER PRINTER BASED ON DISK FOR THESE TWO FINE COMPUTERS.

UP TO 1000 ADDRESSES PER DISK, ALL DISK COMMANDS ARE EXECUTED BY THE PROGRAM. ADDRESSES MAY BE PRINTED FOR ENVELOPES, OR USED ON ANY STANDARD LETTERS STORED WITHIN THE PROGRAM.

£150 ON DISK. INC POSTAGE.

NOTE:- ALL OF OUR STANDARD PROGRAMS ARE NOW AVAILABLE ON DISK FOR APPLE II & I.T.T 2020. JUST ADD £2 PER DISK, MAX. 10 PROGRAMS PER DISK.

RING US NOW FOR A FREE COPY OF OUR CATALOGUE. LOUGHBOROUGH (0509) 217671.

WE WRITE MICRO-COMPUTER PROGRAMS:

PHONE US AND DISCUSS YOUR SOFTWARE REQUIREMENTS, WE CAN WRITE PROGRAMS IN:- BASIC * COBOL * FORTRAN * PASCAL, MAYBE ONE OF OUR STANDARD PROGRAMS WILL SOLVE YOUR PROBLEM, WE HAVE 101 IN OUR LATEST CATALOGUE- AT INCREDIBLE PRICES!!

(0509) 217671 FOR A FREE CATALOGUE.

WHY BUY A MICRO-COMPUTER FROM

PETALECT ELECTRONIC SERVICING LTD.

BECAUSE

- 1) Established company trading since 1971
- 2) Electronic servicing is our speciality
- 3) We have in-house programmers/systems analysts
- 4) We have our own service engineers
- 5) We will demonstrate the PET at your premises
- 6) We can customise the PET to your requirements
- 7) We can arrange finance
- 8) We offer, after the three-month warranty, a service contract from £69.50
- 9) You benefit from our experience of having sold over 450 micro-computers to industrial, educational and business, personal users.
- 10) We specialise in programs and interfaces for weighing applications for average weight control and counting etc.



All 'PETS' sold with a Basic Tutorial Tape

8K £550.00 + VAT
16K £675.00 + VAT
32K £795.00 + VAT

New Large
Keyboard 'PETS'
Now in Stock

In our showroom we sell
Books, Programs, etc.

Also available:

24K Memory Expansion Boards (disk-compatible), only £320 + VAT
PET-compatible : dual floppy disk unit with advanced operating system, only £840 + VAT
Large Extension Keyboard for the PET £89.50 + VAT
Telephone for complete system prices : Wide Range of Printers Available

If you require any more information or demonstration regarding the PET 2001/8 or any associated equipment, programs, etc., please contact Mr. P.J.A. Watts or Mr. D.W. Randall at:

PETALECT ELECTRONIC SERVICES LTD
33/35 Portugal Road,
Woking,
Surrey.
Tel. Woking 69032/68497

Shop at:
PETALECT
Chertsey Road,
Woking,
Surrey.
Tel. Woking 21776/23637

February

- **1** **Pascal — the language of microsystems.** Venue: Wembley Conference Centre, Avon Suite. Intensive one-day course during Microsystems 80 — the major conference and exhibition at Wembley. Fee: £85. Contact: IPC, tel: 01-261 8437 or ICS Publishing Company (UK) Ltd, Pebblecoombe, Tadworth, Surrey, KT20 7PA, tel: (03723) 79211.
- **4-5** **Fundamentals of Microprocessors.** Venue: London. For staff with little or no detailed computer hardware background. Gives participants a sound, practical understanding of microprocessors and how they work to form complete systems. Fee: £230 + VAT. Contact: The Course Registrar, Infotech International Ltd, Nicholson House, Maidenhead, Berkshire SL6 1LD, tel: (0628) 39101.
- **4-6** **Microprocessor Workshop.** Venue: Birmingham. Designed for engineers with little or no knowledge of microprocessors. The course is based on the AIM65 board and introduces all aspects of software development by practical programming sessions. Fee: £195 + VAT. Contact: Microsystems Consultants Ltd, PO Box 65, Camberley, Surrey GU15 1QN, tel: (0276) 27417.
- **4-8** **Tools and techniques for systems development.** Venue: London. Five-day course on the major methods and techniques of software engineering. Fee: £495 + VAT. Contact: Keith London Associates, 6 St Albans Road, Codicote, Hitchin, Herts, tel: 0438 820309.
- **5-8** **Digital image processing.** Venue: London, Royal Horseguards Hotel, Whitehall Court, London, W1A 2AU. Gives information on industrial, scientific and military applications and provides a comprehensive introduction to state-of-the-art digital image processing techniques. Fee: £470 + VAT. Contact: ICSP (UK), Pebblecoombe, Tadworth, Surrey, KT20 7PA, tel: 03723 79211.
- **6-8** **How to program microprocessor systems in assembler.** Venue: London. Designed for engineering and software staff with a fundamental knowledge of microprocessor systems; enables the participant to produce reliable, efficient programming using the facilities of his own specific microprocessor system. Fee: £340 + VAT.
- **11-15** **APL.** Venue: Cannock, Staffs. The course is designed to enable staff with some experience to program in this powerful and increasingly utilised language. Fee: £245 + VAT. Contact: Compower Training School, Cannock, Staffs, WS11 3HZ, tel: Cannock 2511.
- **13** **Principles of teleprocessing and VTAM/SNA concepts.** Venue: Cannock, Staffs. A one-day seminar designed to introduce these topics to operations staff. Fee: £50 + VAT. Contact: Compower Training School, Cannock, Staffs, WS11 3HZ, tel: Cannock 2511.
- **14-15** **Introduction to Microprocessing.** Venue: Bedford.
 & **28-29** Designed for participants from a wide range of backgrounds who need to acquire the intuitive 'feeling' needed to implement or supervise the implementation of microprocessing in their work environment. Fee: £95 + VAT. Contact: Mike Hughes, Microprocessor Training Centre, Texas Instruments Ltd, Manton Lane, Bedford, MK1 7PA, tel: 0234 67466.
- **15** **Introduction to computers and their applications.** Venue: London. Provides an awareness of the potential for computer application within the small company, and provides participants an opportunity to use main-frame and microcomputers in an informal small-group environment. Fee: Members, £50 + VAT; non-members, £60 + VAT. Contact: London Chamber of Commerce and Industry, 69 Cannon Street, London, EC4N 5AB, tel: 01-248 4444.
- **15-17** **Home computing II: Basic and beyond.** Venue: Woodlands Park, Woodlands Lane, Stoke D'Abernon, Cobham, Surrey, KT11 3QB. Second part of course on home computing, for those who wish to enhance their style and extend their knowledge and programming abilities by using hex and decimal machine codes. Fee: £30 Contact: Norman Day, Woodlands Park Residential Education Centre, Woodlands Lane, Stoke D'Abernon, Cobham, Surrey, KT11 3QB, tel: Oxshoot 2215.
- **18-22** **Interactive testing (CMS).** Venue: Cannock, Staffs. Enables programmers to use a terminal to develop, edit, compile and test their Cobol programs. Fee: £245 + VAT. Contact: Compower Training School, Cannock, Staffs, WS11 3HZ, tel: Cannock 2511.
- **20-22** **Advanced microprocessor prototyping laboratory software.** Venue: Bedford. Designed for the technician or engineer who can write 9900 assembly language programmes and can use the FS 990/4 development system. Enables the participant to debug target system software and hardware. Fee: £250 + VAT. Contact: Mike Hughes, Microprocessor Training Centre, Texas Instruments Ltd, Manton Lane, Bedford, MK1 7PA, tel: 0234 67466.
- **21** **How to negotiate computer contracts.** Venue: London. Designed to make delegates aware of the pitfalls, and how to avoid them, in negotiating contracts with manufacturers. Covers difficulties which face new users and endeavours to enable them to achieve their objectives. Fee: Members: £19 + VAT. Non members: £24 + VAT. Contact: The London Chamber of Commerce and Industry, 69 Cannon Street, London, EC4N 5AB, tel: 01-248 4444.
- **25-26** **Microprocessor-based systems for instrumentation and measurement.** Venue: London. Shows how microprocessors can be used to enhance the performance of instrumentation and measurement systems and will be equipped with the practical knowledge to design such systems incorporating microprocessors. Fee: £230 + VAT. Contact: The Course Registrar, Infotech International Ltd, Nicholson House, Maidenhead, Berkshire, SL6 1LD, tel: 0628 39101.
- **26-29** **Fiber optic communication systems.** Venue: London. Designed for engineers, scientists and managers involved in the planning, design and practical implementation of all types of communication systems. Covers the fundamental principles of fiber optic-based systems. Fee: £470 + VAT. Contact: ICSP (UK), Pebblecoombe, Tadworth, Surrey, KT20 7PA, tel: 03723 79211.
- **26-29** **Filetab.** Venue: Cannock, Staffs. Filetab is report generator and file maintenance package designed by NCC. Gives instruction for the TAB-N (ICL) version. Fee: £215 + VAT. Contact: Compower Training School, Cannock, Staffs, WS11 3HZ, tel: Cannock 2511.
- **26-29** **Structured Programming.** Venue: Royal Horseguards Hotel, Whitehall Court, London, SW1A 2EJ. Course in scientific and engineering applications. Will enable participants to gain a clear understanding of the concepts and applications of structure methodology, and develop skills which will enable the production of reliable, well-documented and maintainable programs. Fee: £470 + VAT. Contact: ICSP (UK), Pebblecoombe, Tadworth, Surrey, KT20 7PA, tel: 03723 79211.

A PRACTICAL GLOSSARY

Continuing the terminological gamut with P

Prefix multipliers

This is a bit of maniac fun, some of the most useless information you could hope to acquire. You might have noticed that scientists and jargon generators generally like to express numbers by a factor of 10. Here's what they mean:

prefix	symbol	meaning
deci	d	10
hecto	h	100
kilo	k	1000
mega	M	1,000,000
giga	G	1,000,000,000
tera	T	1,000,000,000,000

Note the difference between 'k' and 'K'. One means 'times 1,000'; the other means 'times 1,024'. Why such an odd number? It's 2^{10} , and is handy, being so nearly 1,000 — in working decimal to binary conversions.

Getting smaller, you get:

centi	c
milli	m
micro	μ
nano	n
pico	p

There are two more, 'feinto' and 'atto', meaning 10 followed by 14 and 17 zeros respectively, but you can safely forget them.

Processor Technology

A pioneer and an early casualty of the US personal computer business, manufacturer of the well-liked Sol system which featured several novel ideas, including an operating system in ROM. Processor Technology was also one of the first companies to make S-100 boards as accessories for the Altair computer. The company went into liquidation this year.

Proprietary software

Programs for which the legal title is held by someone other than the user. The point is that in law you are not allowed normally to copy, re-sell, or amend someone else's program. The question of who 'owns' software is still in the air, though you would have to change someone else's programs very thoroughly to claim them as your own.

Prototype

Prototyping is the development phase in a microprocessor-based product. We tend to see only the man-machine end of computing, with people creating and running programs as the normal use of a micro system. Most microprocessors

are used in products where they are almost invisible, like sewing machines, ovens, cars, automatic manufacturing, and even pocket calculators.

To develop the software for these you need a *prototyping* system, which is a programmable version of your chosen micro configured with a terminal and some storage. You will probably have a PROM programmer attached, too; that allows you to correct your program and then burn it into a PROM which will be buried eventually in the end-user product along with your micro.

Obviously the first fruits of this process will be a *prototype*; because you will be expecting errors, you will produce only a few and you will spend a good deal of time checking them.

Power fail

Or rather, 'power-fail option' or 'power-fail/re-start' or 'power-fail/auto-re-start', since it is obvious what power failing will mean. The better class of computer includes a device which monitors the power level. When voltage drops below a pre-set figure, this hardware option signals an imminent power failure and uses the milliseconds available to store the current contents of all important registers in some kind of non-volatile memory.

This could be core or battery-powered MOS. When the power can be returned, the registers are all re-instated so that things can proceed as before.

Practical Computing

What can one say? Thanks for buying it, and don't stop now.

Preventative maintenance

Things go wrong with computers, and when they do they can be expensive to repair. Even small personal computers should have regular service with the aim of preventing any faults, rather like car services.

Printer

Check *matrix* and *line* printers. A printer is a device which prints information sent from a computer on to paper. The principal examples are *matrix* printers — characters formed by dots when a pin thumps an inked ribbon on to paper; *chain* or *band* line

printers — fast, noisy and expensive; *thermal* printers — dots formed by heating points on treated paper; *electron sensitive* printers — much the same but using electricity; *daisywheel* or *petal* printers — good-quality output; and *ink-jet* — complicated but possibly the coming thing.

Printwheel

Same as *daisywheel*, when that term is used to refer specifically to the print element, the removable disc-like bit with the characters formed on it.

Private line

Also called *leased line* or *private wire*. It is possible to rent your own telephone line from the Post Office. You have to specify where it goes from and to, of course, but once you have it, you can send data to the other end at any time.

With ordinary public telephone systems you pay by 'connect time'. You might not make contact when you want and you will suffer all the inevitable electrical interference as well as any crossed lines and poor connections. None of that applies if you lease a private line. You will pay for the privilege, of course.

Procedure

In programming, this word will probably be used to mean a sequence of steps required to solve some problem. You might meet it in the phrase 'procedure-orientated language'; synonymous is 'problem-orientated language'.

Either way, it means a programming language in which the way you write programs reflects directly the process of solving a problem. The obvious example is something like Algol, where a statement in a program is an explicit algorithmic sequence of operations to be done. Most high-level programming languages are also procedure-orientated, some more formally than others.

Processor

Same as CPU. That portion of the computer which processes instructions. To back-track slightly, a computer comprises processor, internal memory, some kind of input-output device(s), and probably some external storage. Programs are received by the processor from an input source, from memory, or from

storage; they are decoded by the processor, probably with reference to system software held in memory; they are executed by the processor, which probably will involve calling information from memory or backing store on which operations are performed; and the results are despatched by the processor to an appropriate destination, like an output device or a disc store.

The terms 'computer' and 'processor' are employed usually rather more loosely, though, and are treated frequently as being synonymous. To some extent they are; many, but not all, of the essential characteristics of a computer system derive directly from the characteristics of the processor. Even so, it is important to realise that the processor is only one element in the system.

Production control

Running a manufacturing organisation is another classic case for computerisation. The problem is to meet orders placed; applying computers means that everything is so organised that the customer receives the goods on time. Other benefits might include faster delivery, less capital tied-up in inventory, and better use of machinery.

On the other hand, to obtain all those benefits you have to integrate every possible factor. This will involve sales forecasting, planning what raw materials and other resources you will need, and when; deciding what levels of stock-holding you require; and so on. It can all become big and complex; you might need a big computer to cover it all, and you might have to be a big company to derive any benefit from the outlay on your system.

Smaller companies and smaller computers can have parts of the full idealised system, of course — forecasting and stock control are the obvious examples. Anyone who can produce a flexible, full-blown production control system on a micro ought to clean up.

Production run

Like running a program, as opposed to test runs.

Programme

A collection of ads and the case list for which you pay exorbitantly when you pay your thrice-annual visit to *No Sex Please We're British*.

£7,000
OR LEASE AT £182PM — OR RENT
COMPLETE SYSTEM
FOR THE
NOT SO SMALL BUSINESS

(though it may not be a multi-national it is vital to to you
and important to us)

SOPHISTICATED APPLICATION
SOFTWARE

(IN COBOL — THE PROFESSIONAL BUSINESS LANGUAGE) Comprehensive in
content (just compare it), easy to use.

INVOICING, SALES LEDGER, PURCHASES LEDGER, MAILING; CASH & BANK
ACCOUNT, ANALYSIS, ASSETS REGISTER; NOMINAL LEDGER, MANAGEMENT
& FINAL ACCOUNTS, PAYROLL ORDER PROCESSING, JOB COSTING, STOCK
CONTROL WORD PROCESSING.

PRICE INCLUDES CHOICE OF *ANY FIVE*.

FIRST CLASS POWERFUL
MICRO COMPUTER

64K MEMORY, 1 MEGABYTE DISC STORAGE (EXPANDABLE) ATTRACTIVE DESK, GOOD VISUAL
DISPLAY UNIT, 180 cps 132 pos QUALITY PRINTER. CP/M OPERATING SYSTEM.

£7,000 — inclusive of Hardware, Software and (very important) training, document-
ation, implementation assistance and full professional support.

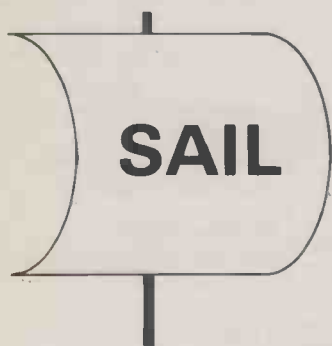

SAIL INFORMATION SYSTEMS

(A Division of Software Aids International Ltd.)
EMBASSY LODGE, 167 GREEN LANES,
LONDON N16 Tel 01-359 2818

LOCAL CONSULTANTS WITH DEMONSTRATION MACHINES IN:
BIRMINGHAM, CAMBRIDGE, STOKE-ON-TRENT, HORSHAM (SUSSEX), HARLOW (ESSEX), ST. ALBANS (HERTS)

• Circle No. 273

DATRON of SHEFFIELD

for

Cromemco the ultimate name in micros



DATRON import direct from Cromemco, California.
 DATRON can supply Nationwide.
 DATRON can provide maintenance nationally
 by C.F.M.

DATRON can give you the realistic prices.
 DATRON have in stock:-

System 2 46K £1995
 System 3 64K £3292
 Hard Disc £4998

DATRON can supply Systems 2 and 3 with
 Multi-Tasking facilities. (Hard Disc soon)
 DATRON easily accessible - in the centre of
 the country.

Write or telephone for FREE colour brochure on System 3 or Z-2H.
 We use Cromemco for our own business, why not call in for a demonstration.

DATRON MICRO CENTRE
 DATRON INTERFORM LTD

Latham House, 243 London Road, Sheffield S2 4NF.
 Telephone 0742 - 585490. Telex 547151.

• Circle No. 274

Advertisement Index

A							
Act	86	Crofton	26	Lifeboat Associates	144, 145	Praameterised Computer	
Acorn	104	Crystal Electronics	16	Lion Microcentre	91	Systems	150
Aculab	10	D		Logitex	54	Printout	34
Adda	10	Digitas	50	Lotus Sound	155	Protechnic	150
Aim	164	DAMS	156	Lowe Electronics	39	R	
Airamco	153	Databank	158	LP Enterprises	23	Rair	109
AJD Direct Supplies	18	Datalink	103	LTT	18	Research Resources	14
Algobel Computers	42	Data Systems Supplies	36	M		Rohan	20
Analog Electronics	40	Datron Interform	165	3M Data Recording	89	Rostronics	13
		DDM	126	Microbits	157	S	
B		E		Microcentre	2	Science of Cambridge	121
Basic Computing	125	Electronic Brokers	40	Micro Computer Application	150	Seed	59
Bits and PC's	26	Ensign Computer Systems	41	Micro Computer Centre	152	Sintrom Microshop	29
Bristol Software Factory	8, 9	Equinox	11	Micro Control	32	Sirtom Products	36
Business Computer Services	34	Essex Computer Services	32	Microdata	28	Slough Microshop	158
Butel Compco	17	F		Microdigital	14, 84, 85	Software House	34
Butterworth	48	Feldon Audio	152	Micrologic	30	Stack	19
Bytehurst	158	Flyde Micro Services	42	Micromanagement	154	Stage One	12
		G		Micromedia (Systems)	118	Strutt	24
C		Gemsoft	24	Microsolve	16	Systematics International	20
Cambridge Computer Store	38	Graffcom	154	Microsystems '80	43	T	
Cambridge Learning		Grama (Winter)	4	Microtek	34	T & V Johnson	148, 149
Enterprises	24	H		Midlectron	31	Tandy	146, 147
Camden Electronics	28	Happy Memories	18	Muller	25	Tally Printers	122, 123
CCS Microhire	44	Harding, A.J.	44	Mutek	22	Tangerine Computer	
Chromasonic Electronics	46	HB Computers	28	N		Services	45
C.J. Communications	46	I		Newbear	26	Technalogs	30
Comart	5, 97	Interactive Data Systems	42	Newtronics	94	Telesystems	16
Commodore	65, 67, 69	Interface	160	O		Terodec	33
Comp Computer		Intersystems	52	Online	27	Transam	162
Components	166, 167	Intex	126	P		Tridata	156
Computastore	15, 108	K		Padmede	48	V	
Computerama	151	Keen Computers	60	Peripheral Hardware	30	V & T Electronics	22
Computer Centre	37	Kingston Computers	168	Petalect	159	Video Genie	48
Computercrop	46	L		Petsoft	77	Vlasak	49
Computermania	143	L & J Computers	106	Personal Computers	110	W	
Computopia	38	Landsler Software	89	Plessey	32	Westrex	35
Couchmead	6, 7			Portable Microsystems	47	Willis	71
CRA	10					X	
						Xitan	21

8MHz Super Quality Modulators	£4.90
6MHz Standard Modulators	£2.90
C12 Computer Grade Cassettes 10 for	£4.00
Super Multi-rail P.S.U. +5 -5 +12v	£29.50
Nascom I with Nas-sys Kit	Special Price Limited quantities £125.00
Assembled	
ETI Breakout Game - Chip and PCB	£9.90
S100 Expansion Motherboard for Nascom I	£39.00
Anadex Printer Paper - 2000 sheets	£25.00
Floppy Disks 5 1/4" Hard & Soft Sectored	£3.50
Floppy Disk Library Case 5 1/4"	£3.50
Lexicon Language Translator	£125.00
Modules for Lexicon	£29.00
Eprom Boards	£63.00
8K Static Ram Boards - S100	£110.00
Grandstand Video Game	£59.00
Cartridges for Grandstand	£11.99
George Risk Ascii Keyboard	£39.00
Cartridges for Atari - Full Range in Stock	£13.90
Interface PET IEEE - Centronics Parallel Not decoded	£49.00
Decoded	£77.00
Interface to Centronics parallel for TRS80	£75.00
Verocases for Nascom 1 & 2 etc.	£22.50
Keyboard Cases	£9.90
Electric Pencil for TRS80	£29.00

only **£399** + VAT



TRS80 LEVEL 2 16K

Fully converted to UK T.V. Standard. Comes complete with easy to follow manuals UK Power Supply - Cassette Leads - Sample tapes. Special box to enable you to plug into your own TV. Recommended for first time-buyers. Just plug in and go. Full Range of Software Available

NEW REDUCED PRICES

8K **£449** + VAT
16K **£549** + VAT
32K **£649** + VAT

RRP £795 for 32K

The PEDIGREE PETS

Very popular for home & business use. 8K Microsoft Basic in ROM. 8K Pet 32K & 16K with new improved keyboard. All with green screen. Extra cassette deck **£55** Full range of software available.



32K **£690** + VAT
48K **£790** + VAT

EXIDY SORCERER

RRP £859 for 32K

For Personal or Business Use. 32K or 48K memory. 8K Microsoft Basic in ROM. Dual Cassette I/O. RS232 I/O. Parallel I/O (Centronics). Expansion available through optional extra S100 Motherboard. 69 Key keyboard including 16 key numeric pad.

S100 EXPANSION - £199



RRP £975 for 48K
48K - **£690** + VAT



ITT 2020

Full colour into your own colour T.V. PALSOFT 9 digit floating point Basic in ROM as standard. Low and High resolution graphics. Built in loudspeaker. Compatible with most Apple Hardware add-ons and software.

only **£295** + VAT

TRS80 EXPANSION INTERFACE

Expand your TRS80 by 32K. 32K Memory on board. Centronics parallel port. Disk controller card. Real time clock. Requires Level II Basic. Interface for 2 cassette decks complete with power supply.



RRP £540
only **£499** + VAT

ANADIX DP8000

Super Quality - Low cost printer. Tractor Feed with full 96 ASCII character set. Accepts RS232C at band rates between 100 and 9600 and Parallel Bit data. Attaches either directly or through interfaces to Pet, Apple, TRS80, Sorcerer, Nascom, CompuKit etc.



RRP £690
only **£590** + VAT

IBM SELECTRIC GOLFBALL

Refurbished IBM Golfball Printers to new specs. Accepts Centronics parallel data. Friction feed. Prints at 15 cps. Attaches either directly or through interfaces to Pet, Apple, TRS80, Sorcerer, Nascom, CompuKit etc.



video 100

12" BLACK & WHITE LOW COST VIDEO MONITOR

RRP £79
only **£69** + VAT

- Ideal for home, personal and business computer systems
- 12" diagonal video monitor • Composite video input
- Composite video input • Compatible with many computer systems
- Solid-state circuitry for a stable & sharp picture
- Video bandwidth - 12MHz + 3dB
- Input impedance - 75 Ohms
- Resolution - 650 lines Minimum In Central 80% of CRT; 550 Lines Minimum beyond central 80%.



NASCOM-2 MICRO-COMPUTER

only **£295** + VAT

FREE POWER SUPPLY



Microprocessors Z80A 8 bit CPU. This will run at 4MHz but is selectable between 1/2/4 MHz. This CPU has now been generally accepted as the most powerful, 8 bit processor on the market.

INTERFACE

Keyboard New expanded 57 key Licon solid state keyboard especially built for Nascom. Uses standard Nascom, monitor controlled, decoding. T.V. The tv peak to peak video signal can drive a monitor directly and is also fed to the on-board modulator to drive the domestic T.V.

I.O. On-board UART (Int.6402) which provides serial handling for the on-board cassette interface or the RS232/20mA teletype interface. The cassette interface is Kansas City standard at either 300 or 1200 baud. This is a link option on the NASCOM-2. The RS232 and 20mA loop connector will interface directly into any standard teletype. The input and output sides of the UART are independently switchable between any of the options - i.e. it is possible to house input on the cassette and output on the printer.

PIO There is also a totally uncommitted Parallel I/O (MK3881) giving 16, programmable, I/O lines. These are addressable as 2 x 8 bit ports with complete handshake controls.

Documentation Full construction article is provided for those who buy a kit and an extensive software manual is provided for the monitor and Basic.

Basic The Nascom 2 contains a full 8K Microsoft Basic in one ROM chip with additional features like DEEK, DOKE, SET, RESET for simple programming. With free 16K RAM board.

HITACHI PROFESSIONAL MONITORS

9" - **£129**
12" - **£199**

- **Reliability** Solid state circuitry using an IC and silicon transistors ensures high reliability.
- **500 lines horizontal resolution** Horizontal resolution in excess of 500 lines is achieved in picture center.
- **Stable picture** Even played back pictures of VTR can be displayed without jittering.
- **Looping video input** Video input can be looped through with built-in termination switch.
- **External sync operation** (available as option for U and C types)
- **Compact construction** Two monitors are mountable side by side in a standard 19-inch rack.



A PROFESSIONAL WORD PROCESSING SYSTEM AND IT'S A COMPUTER AS WELL.

FOR ONLY **£3250** + VAT



PET 32K - This is the standard 32K Pet from Commodore. Reverse video and graphics allow the WordPro Package to give simple clear and easy to read displays.

2040 Disk Drives Twin disk drives allow large high speed storage for your letters, or paragraphs. Plugs in the back of the PET.

NEC Spinwriter NEC's high quality printer uses a print "thimble" that has less diameter and inertia than a daisy wheel, giving a quieter, faster, more reliable printer that can cope with plotting and printing (128 ASCII characters) with up to five copies, friction or tractor fed. The ribbon and thimble can be changed in seconds. 55 characters per second bidirectional printing - with red/black, bold, subscript, superscript, proportional spacing, tabbing, and much, much more.

WordPro II The heart of the system - consists of a ROM and diskette. The ROM is inserted into a space socket inside the Pet. One of the most versatile Word Processing Packages around.

COMPUKIT UK101

EUROPE'S FASTEST SELLING ONE BOARD COMPUTER



Simple Soldering due to clear and concise instructions compiled by **Dr. A.A. Berk, BSc. PhD.**

- ★ 6502 based system — best value for money on the market.
- ★ Powerful 8K Basic — Fastest around
- ★ Full Qwerty Keyboard
- ★ 4K RAM Expandable to 8K on board.
- ★ Power supply and RF Modulator on board.
- ★ No Extras needed — Plug-in and go.
- ★ Kansas City Tape Interface on board.
- ★ Free Sampler Tape including powerful Dissampler and Monitor with each Kit.
- ★ If you want to learn about Micros, but didn't know which machine to buy then **this is the machine for you.**

Build, Understand and Program your own Computer for only a small outlay.

KIT ONLY £199 + VAT
NO EXTRAS NEEDED

AVAILABLE READY ASSEMBLED & TESTED
READY TO GO FOR **£249 + VAT**

Specially designed case for CompuKit in orange/black. With room for accessories **£29.50 + VAT**

6502 Assembler/Editor for CompuKit £14.90 + VAT

The **CompuKit UK101** comes in kit form with all the parts necessary to be up and working, supplied. No extras are needed. After plugging in just press the reset keys and the whole world of computing is at your fingertips. Should you wish to work in the machine code of the 6502 then just press the M key and the machine will be ready to execute your commands and programs. By pressing the C key the world of Basic is open to you.

This machine is ideal to the computing student or Maths student, ideal to teach your children arithmetic, and is also great fun to use.

Because of the enormous volume of users of this kit we are able to offer a **new reduced price of £199 + VAT**



THE NEW TRS80 SURPRISE — MODEL II

Fast and expandable!

Model II operates at twice TRS-80's high speed.

In addition to either 32 or 64 thousand characters (bytes) of internal Random Access Memory, one built-in 8" floppy disk stores an additional one-half million bytes, including the Disk Operating System. And you can easily expand up to a four-disk system for up to two-million bytes of storage.

Model II features upper and lower case letters. Its built-in 12" high-resolution video monitor displays 24 lines of 80 normal characters. The professional 76-key keyboard (with "calculator" keypad) includes advanced functions such as Control, Escape, Caps, Hold, Repeat. The keyboard is detachable and moveable for convenient data entry.

You get the enhanced Level III version of TRS-80's already-famous Level II BASIC language and "TRSDOS" operating system, automatically loaded in memory when you "power up." (About 24K of RAM is used by this software.)

Each time you power up, Model II thoroughly tests itself to insure proper operation. Your chosen program can appear immediately, without any intermediate steps or questions to answer.

Versatility ... plug-in expandability

Built-in input/output capabilities include two RS-232C channels, and one Centronics parallel port. Future expansion is provided through four plug-in slots for optional PC boards.

32K 1-Disk Model II
£1999.00 + VAT

64K 1-Disk Model II
£2200.00 + VAT

3 DISK EXPANSION

500K per Drive gives total of 1.5M Byte for only **£1399 + VAT**

Just Plug In

WE ARE NOW EX-STOCK



Why do people buy more from COMPSHOP than anywhere else?

- ★ **LARGER STOCKS** — we hardly ever run out
- ★ **GOOD SERVICE** — we give extended warranties on all our products.
- ★ **EXCELLENT REPAIR SERVICE** — Through CompuCare we repair and maintain most makes of personal computers.

LAST YEAR WE SUPPLIED TO THE PUBLIC — LARGE & SMALL
16,000 Television Games & 7,000 Computer Systems



CompuCare is a company that has been set up to provide servicing and maintenance for the popular makes of micro-computers i.e. Sorcerer, Pet, Apple, TRS80, Nascom, CompuKit. Our charges are £7 per hour plus parts.

Because of the extensive range of spare parts stocked you can usually expect your micro to be repaired within 10 days for an average charge of £14 labour.

Emergency 24 hour repairs can be handled for a £10 surcharge where possible.
CompuKits and Nascoms unsuccessfully constructed will be charged a standard £25.



THE ATARI VIDEO COMPUTER SYSTEM

£138 + VAT

Atari's Video Computer System now offers more than 1300 different game variations and options in twenty great Game Program™ cartridges!

Have fun while you sharpen your mental and physical coordination. You can play rousing, challenging, sophisticated video games, the games that made Atari famous.

You'll have thrill after thrill, whether you're in the thick of a dogfight, screeching around a racetrack, or dodging asteroids in an alien galaxy. With crisp bright colour (on colour TV) and incredible, true-to-life sound effects. With special circuits to protect your TV.

Cartridges now available All at £13.90 each + VAT

Basic Maths, Airsea Battle, Black Jack, Breakout, Surround, Spacewar, Video Olympics, Outlaw, Basketball, Hunt & Score*, Space War, Sky Diver, Air Sea Battle Codebreaker*, Miniature Golf.

Extra Paddle Controllers — **£14.90 + VAT**

*Keyboard Controllers — **£16.90 + VAT**



Please add VAT to all prices — Delivery at cost, will be advised at time of purchase. Please make cheques and postal orders payable to COMPSHOP LTD., or phone your order quoting BARCLAYCARD, ACCESS, DINERS CLUB or AMERICAN EXPRESS number.

CREDIT FACILITIES ARRANGED — send S.A.E. for application form.

14 Station Road, New Barnet, Hertfordshire, EN5 1QW Tel: 298755 TELCOM G

Telephone: 01-441 2922 (Sales) 01-449 6596

OPEN · 10 am · 7 pm — Monday to Saturday

★ NOW OPEN ALL DAY SUNDAY — For Shop Sales Only ★

Close to New Barnet BR Station — Moorgate Line.



(Part of the Compsshop Ltd. Group)

MICROTEK

OUTPERFORMS THEM ALL!



V CHECK THESE FEATURES...

- 80 or 120 columns (software selectable)
- Double width printing
- Non-thermal paper, pin feed
- 125 CPS, 70 lines per minute
- 9 x 7 dot matrix
- Vertical format unit
- 96-character ASCII (upper and lower case)
- Adjustable forms width
- Parallel, serial (RS-232), and IEEE-488 interfaces available

We've researched the under-£1,000 80-column dot matrix printers currently available, and have made some key comparisons in the chart to the right. Check it out.

All the printers support the full 96-character ASCII set, print on pin feed non-thermal multi-copy paper, accept forms in various widths up to 9.5", and easily interface to all popular small computers.

If you want to print graphics or feed single sheets of paper through your printer, we can't help you. But if you want as much data buffer storage as you can get, a 9 x 7 dot matrix for better looking characters, a condensed character set that's great for printing multiple columns of numbers, a readily available low cost ribbon, and documentation that includes complete schematics and troubleshooting procedures, then we can help you a lot. And we can offer you something else that's new to the low-cost printer market. Our 30 day BUY BACK guarantee. If you buy a MICROTEK printer and are unhappy with it, for any reason, you can return it within 30 days for a full refund. It's that simple.

Does MICROTEK really outperform them all? You be the judge.

KINGSTON

Computers Limited.

● Circle No. 310

A Member of the Dale Group of Companies.



V CHECK THIS CHART...

Features	MICROTEK MT-80P	Anadex DP-8000	Centronics 730-1 (Radio Shack 26-1154)	Super Brain LP-80	Integral Data 440	MPI 88T
9 x 7 Dot Matrix	Yes	Yes	No	No	No	No
Sustained thrupt for full lines	70 LPM	84 LPM	21 LPM	63 LPM	42 LPM	60 LPM
Selectable condensed character set	Yes	No	No	No	Yes	Yes
Full function VFU	Yes	Yes	No	No	Yes	No
Built-in self test	Yes	No	No	No	Yes	No
Graphics option	No	No	No	No	Yes	No
Accepts single sheets of paper	No	No	Yes	No	No	Yes
Ribbon costs	£1.00	£4.50	£4.75	NA	£1.05	NA
Cost of 2k/4k buffer	£15/£28	£12.25/£24.50	NA/NA	NA/NA	115*/NA	NA
Unit price	£495	£575	£559	NA	£585	NA

* Memory buffer alone not available, includes graphics option

Comparison data from manufacturer's current (September '79) literature.

NOW CHECK THIS COUPON...

TO: KINGSTON Computers Limited — Scarborough House — Scarborough Road — Bridlington — (0262) 73036



Send me more information.

I have a TRS-80 PET APPLE
My application is Business Home/Hobby

Check or Money Order enclosed. Charge my Barclay card Charge my Access card

Name (Please print) _____

Address _____

Phone _____

Card number _____ Exp date _____

Cardholder's signature _____

Send me a printer with:

Parallel interface at £495. Plus £74.25 VAT.

Serial interface at £525. Plus £78.75 VAT.

IEEE-488 interface at £550. Plus £82.50 VAT.

P. & P. FREE

Dealer inquiries invited.